



STREAMLINE YOUR WORKFLOW™

When you choose TengTools you immediately stand out from the crowd as an individual who is intent on achieving their goals.

TengTools offer a modular tool system that is built to last. Build your ultimate tool kit with our large selection of storage and tool sets enabling customised tool solutions for any kind of industry or profession.

Get Organised™ with a tool control system designed to boost efficiency and save time.

DEVELOPED TO MAKE YOUR JOB EASIER



TAILOR YOUR TOOL SOLUTION TO YOUR NEEDS

TengTools offer a modular tool system that is built to last.

Build your ultimate tool kit with our large selection of storage and tool sets enabling customised tool solutions for any kind of industry or profession.

Don't waste space and money on tools you don't need. Buy the exact tools you require and if you need more in the future, just add new sets that fit seamlessly into your storage solution.

When you purchase TengTools you are guaranteed the highest quality. If a tool is worn out or if you happen to lose a piece, individual tools can be easily purchased as replacements.



“ One of the best feelings at work is being in the zone, work feels effortless, everything else falls away, and you get things done. ”

GET ORGANISED FOR A BETTER WORKFLOW

Keep your high runners within arm's length and the others close by. This creates the perfect workflow and maximises efficiency. Your fully organised toolbox is always kept tidy and no time is wasted searching for tools.



Get started with our Tool Control System.

Our Tool Control System offers the widest selection in the market. With storage solutions in all sizes from large stationary cabinets to small portable service cases and more than 240 tool sets to choose from it's easy to create a bespoke tool kit that suits your exact needs. The TengTools Tool Control System is modular and the standard tool sets fit in all the different storage solutions enabling you to move tool sets from a roller cabinet over to a portable service case if you need to bring them with you for a specific job 'on the go'.

To get started, just choose your storage, choose your tool sets, and click them together. It's easy to Get Organised!



“ We don't have time to waste, we need our tools to be ready when we need them. Everything has a specific place. The tool kits look damn good too! ”

THE RIGHT TOOLS IN THE RIGHT PLACE

Looking for misplaced tools, or not having the right tools within reach is the kind of distractions that slow you up and makes work less efficient. TengTools is making it easier to have your high runners within reach and the odd ones close enough.

And above all it's a piece of cake to keep all your tools clean and in perfect order.



Being organised is crucial when building a submarine.

Kockums are building the world's most sophisticated AIP Submarine. To deliver on time and budget, they needed to organise thousands of tools required for every aspect of the build. TengTools tool control system turned out to be a perfect match.





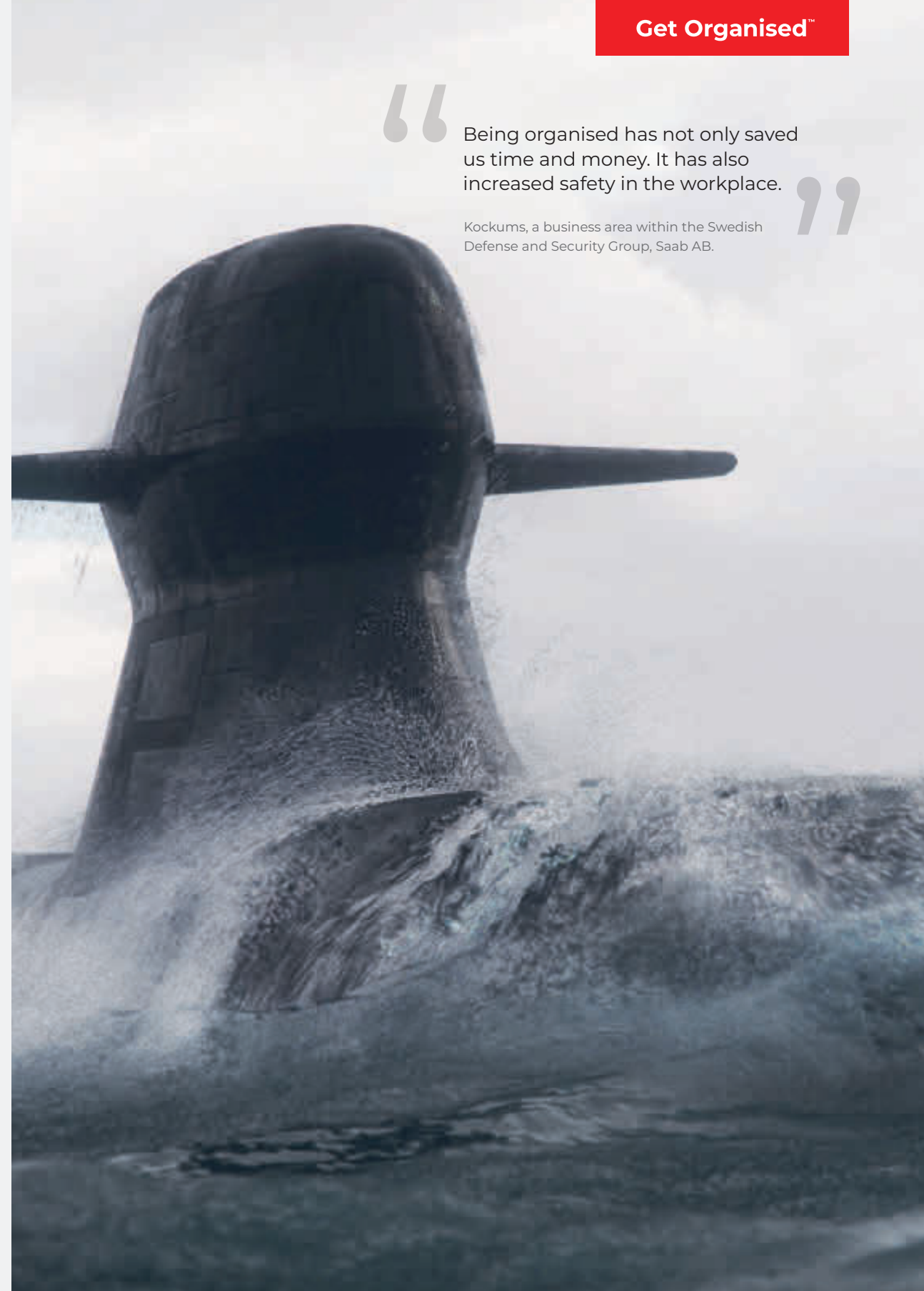

Every engineer has their own personal set up of high runners in a portable tool case, each workstation team has a fully equipped roller cabinet for daily use, and in the shipyard's tool room they have over 4000 hand tools easily accessible when required.







“ Being organised has not only saved us time and money. It has also increased safety in the workplace. ”



Kockums, a business area within the Swedish Defense and Security Group, Saab AB.





















TOOL KITS	10
 Stacks	12
Roller Cabinets	41
Work Station	55
Top Boxes	58
Portable	62
TOOL STORAGE	70
 Stacks	72
Top Boxes	75
Middle Boxes	78
Roller Cabinets	80
Side Cabinets	88
Accessories	91
TOOL CONTROL SYSTEM	106
 TT Series	110
FOAM Series	154
Wall Racks	183
SOCKET SETS	188
 1/4" Drive	190
3/8" Drive	198
1/2" Drive	208
3/4" Drive	218
1" Drive	221
Mixed Drive Sets	221
Impact	224
SOCKETS & ACCESSORIES	232
 Ratchets	237
Accessories	239
1/4" Drive Sockets	242
3/8" Drive Sockets	247
1/2" Drive Sockets	256
3/4" Drive Sockets	263
1" Drive Sockets	265
Impact Accessories	267
Impact Sockets	268
TORQUE TOOLS	280
 1/4" Drive	282
3/8" Drive	283
1/2" Drive	286
3/4" Drive	288
Insert Tools	290
Accessories	292

SPANNERS & WRENCHES	296
 Combination	298
Ratcheting	310
Double Ring	316
Double Open	320
Wrenches	322
Adjustable Wrenches	328
SCREWDRIVERS	330
 Mini Screwdrivers	332
Loose Screwdrivers	334
Double Ended Blades	340
Power Through	341
Nut Drivers	342
Screwdriver Sets	343
BITS & DRIVERS	350
 Individual Bits	352
Adaptors & Extensions	360
Bits Sets	362
Bits Drivers & Sets	369
Impact Bits	375
HEX & TX KEYS	378
 Hex Keys	380
TX Keys	391
PLIERS	398
 Cutters	400
Combination Pliers	404
Water Pump Pliers	406
Pipe Wrenches	409
Circlip Pliers	413
Power Grip Pliers	417
INSULATED TOOLS	422
 Screwdrivers	404
Torque Screwdriver	430
Pliers	431
Sockets & Accessories	434
CUTTING TOOLS	436
 Tin Snips	438
Saws	440
Knives	442
Drill Bits	445
Taps & Dies	446
Files	449

MEASURING TOOLS	452
 Micrometer & Calipers	454
Gauges & Rules	455
Angles	456
Measuring Tapes	458
Spirit Levels	459
AUTO TOOLS	460
 Hooks	461
Hose Tools	463
Engine Tools	464
Wheel Tools	469
Body Tools	471
SERVICE TOOLS	474
 Pullers	475
Extractors	477
Pry Bars	480
Crimping/Wire Stripping Tools	481
Voltage Testers	483
Pipe Cutters	484
Rivet Tools	488
Inspection Tools	491
Lighting	493
Workshop	495
Clamping Tools	498
Striking Tools	499
Fall Protection	503
Safety Glasses	504
AIR TOOLS	507
 Ratchets	508
Impact Wrenches	509
Drills	513
Cutting & Grinding	515
Needle Scaler / Rivet Gun	518
Blow Guns	519
INDEX	520
 Alphabetic Index	520
Alphanumeric Index	527

Tool Kits	
Tool Storage	
Get Organised System	
Socket Sets	
Sockets & Accessories	
Torque Tools	
Spanners & Wrenches	
Screwdrivers	
Bits & Drivers	
Hex & TX Keys	
Pliers	
Insulated Tools	
Cutting Tools	
Measuring Tools	
Auto Tools	
Service Tools	
Air Tools	

TOOL KITS

BETTER TOOLS BRING BETTER RESULTS

When you are working on any task you take pride in what you are doing.

You want the best. When you choose TengTools you immediately stand out from the crowd as an individual who is ready to succeed.



Each tool kit has been compiled with the help of technicians from various trades

Boost your efficiency. All tools are supplied in our unique Tool Control System where every tool has it's own place making it easy to find the tool you need

Tool kits are available in many shapes and sizes. From full stacks to roller cabinets, and top boxes to portable solutions, there is a kit to fit your exact needs

Tool kits with worktop surfaces are also available creating portable workstations



TT
SERIES



MONSTER™

53" PRO MONSTER TT TOOL KIT 1100 PIECES

- A complete tool kit covering the requirements of most users
- Includes a 1/2" drive composite air gun together with a wide range of impact sockets
- All the tools are laid out in individual tool trays using the TengTools Get Organised system
- Easy to see if any tools have been mislaid or lost helping to prevent leaving them with the work piece
- Supplied in the TengTools double width TC810N 10 drawer top box and the TCW809N 9 drawer 53" wide roller cabinet

- 19 Drawer**
- 53" Wide Cabinet**
- Heavy Gauge Steel**
- 5-Step Rust Protection**
- 6" Castor Wheels with Brakes**
- 3 Step Ball Bearing Slides**
- Comfort Grip Handle**
- Combination Lock**

1100
Pieces 317 kg

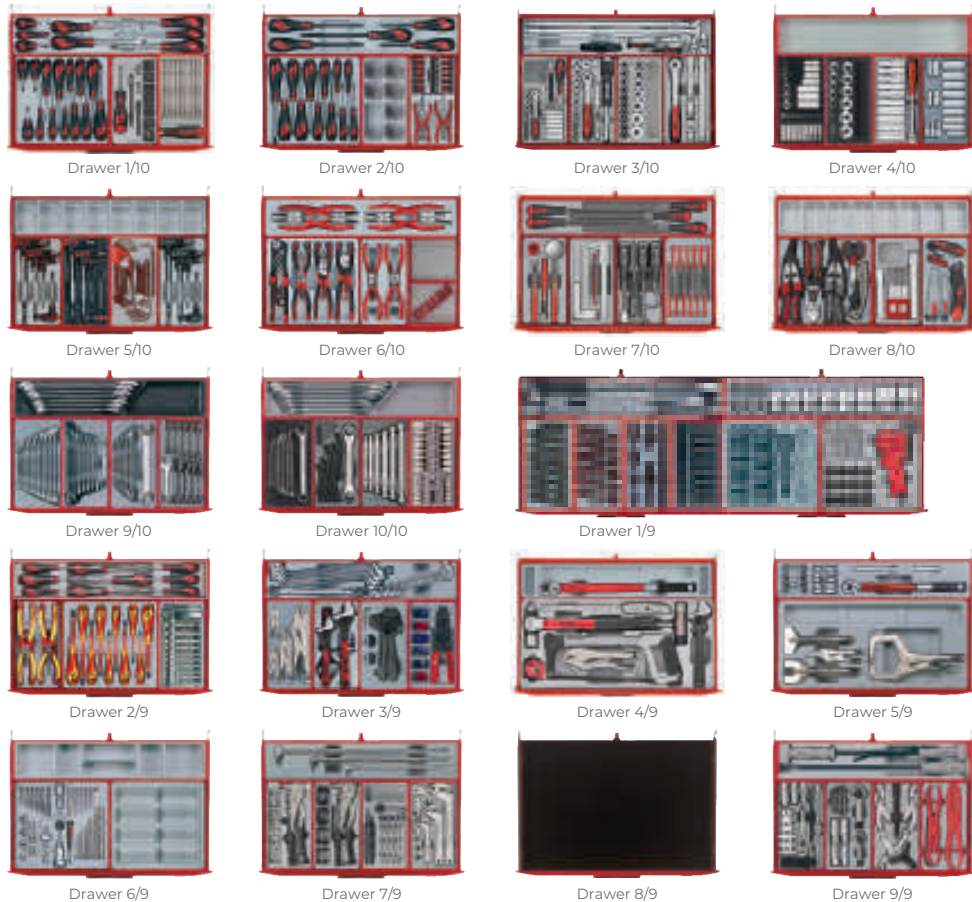

Drawer	Item ID	Description
Storage	TC810N	Tool Box Top Box 10 Drawer
	TCW809N	Tool Box Roller Cabinet 9 Drawer 53in
1/10	TTD914N	Screwdriver Set Mixed TT2 14 Pieces
1/10	TTMD74	Ratcheting Screwdriver Bit Set TT1 74 Pieces
1/10	TTMD12D	Screwdriver Blade Set Mixed TT1 12 Pieces
1/10	TTX918N	Screwdriver Set Flat & PH TTX4 8 Pieces
2/10	TTD912TXN	Screwdriver Set TX TT2 12 Pieces
2/10	TTM116	Mini Pliers & Screwdriver Set TT1 16 Pieces
2/10	TT01	Storage Tray TT1 7 Compartments
2/10	TTXMDTN	Power Through Screwdriver Set TTX4 5 Pieces
3/10	TT1435	1/4" Socket Set 6 pt TT1 35 Pieces
3/10	TT3819	3/8" Socket Set 6 pt TT1 19 Pieces
3/10	TT1205	1/2" Ratchet & Accessories Set TT1 5 Pieces
3/10	TT1217	1/2" Socket Set 12 pt TT1 17 Pieces
3/10	TTXEXT13	Extension Bars Set TTX4 13 Pieces
4/10	TTAF32	1/4" & 3/8" Socket Set AF 6 pt TT1 32 Pieces
4/10	TT1215AF	1/2" Socket Set 12 pt AF TT1 15 Pieces
4/10	TT1211	1/2" Socket Set 12 pt TT1 11 Pieces
4/10	TT3816	3/8" Socket Set 6 pt TT1 16 Pieces
4/10	TTX00	Storage Tray TTX4 1 Compartment
5/10	TTHEX7	T-Handle Ball Point Hex Key Set TT1 7 Pieces
5/10	TTHEX7AF	T-Handle Hex Key Set AF TT1 7 Pieces
5/10	TTHT28	Ball Point Hex & TX Key Set TT1 28 Pieces
5/10	TTTX7	T-Handle TX/TPX Key Set TT1 7 Pieces
5/10	TTX03	Storage Tray TTX4 8 Compartments
6/10	TTD441-T	Plier Set TPR Grip TT2 8 Pieces
6/10	TT474-7	Circlip Plier Set 19-60 mm TT1 4 Pieces
6/10	TT00	Storage Tray With Tool Holder TT1
6/10	TTX474-9	Circlip Plier Set 40-100 mm TTX4 4 Pieces
7/10	TTM03	Inspection Set TT1 3 Pieces
7/10	TTBM	Measuring Tool Set TT1 4 Pieces
7/10	TTSR04	Scraper Set TT1 4 Pieces
7/10	TTNF12	Needle File Set TT1 12 Pieces
7/10	TTXF05	Hand File Set TTX4 5 Pieces
8/10	TTDCT05	Cutting Tool Set TT2 5 Pieces
8/10	TTK40	Knife Set TT1 40 Pieces
8/10	TTPC09	Punch & Chisel Set TT1 9 Pieces
8/10	TTX03	Storage Tray TTX4 8 Compartments
9/10	TT1236	Combination Spanner Set TT1 12 Pieces
9/10	TT6508R	Ratcheting Spanner Set R TT1 8 Pieces
9/10	TT6208	Double Open Ended Spanner Set TT1 8 Pieces
9/10	TT6010M	Stubby Combination Spanner Set TT1 10 Pieces
9/10	TTX2032	Combination Spanner Set TTX4 7 Pieces

Drawer	Item ID	Description
10/10	TTX2640	Combination Spanner Set AF TTX4 7 Pieces
10/10	TT3592	Combination Spanner Set AF TT1 8 Pieces
10/10	TTRORS	Ratcheting Ring Spanner Set TT1 6 Pieces
10/10	TT6506	Double Flex Wrench Set TT1 6 Pieces
10/10	TTBS35	1/4" & 3/8" Bit Socket Set TT1 35 Pieces
1/9	TT9015HX	3/8" & 1/2" Hex Impact Skt Set DIN TT1 15 Pieces
1/9	TT9212TX	1/2" TX Impact Socket Set DIN TT1 12 Pieces
1/9	TT9207	1/2" Impact Accessories Set DIN TT1 11 Pieces
1/9	TT9116N	1/2" Impact Socket Set ANSI TT1 16 Pieces
1/9	TTX3404	3/4" Ratchet & Accessories Set TTX4 4 Pieces
1/9	TTD9416	3/4" Impact Socket Set DIN TT2 12 Pieces
1/9	TTX3414	3/4" Socket Set 6 pt TTX4 14 Pieces
1/9	TTDAWM13M	1/2" Air Impact Wrench Set TT2 13 Pieces
2/9	TTV440	Insulated Plier Set TT1 4 Pieces
2/9	TTDV910N	Insulated Screwdriver Set Mixed TT2 6 Pieces
2/9	TTHEX23	1/2" Hex Bit Socket Set TT1 23 Pieces
2/9	TTXND	Nut Driver Set TTX4 9 Pieces
3/9	TTVG05	Power Grip Plier Set TT1 5 Pieces
3/9	TTADJ04	Adjustable Wrench Set TT1 4 Pieces
3/9	TTCP121	Crimping Plier Set TT1 121 Pieces
3/9	TTCP04	Crimping Plier Set TT1 4 Pieces
3/9	TTX6311	Double Ring Spanner Set TTX4 11 Pieces
4/9	TTPS09	General Tool Set BP TT4 9 Pieces
4/9	TTX1292	1/2" Torque Wrench 40-210 Nm TTX4
5/9	TTSP0C	Power Grip Plier Set TT4 4 Pieces
5/9	TTX3892	3/8" Torque Wrench Set TTX4 22 Pieces
6/9	TTDTD34	Tap and Die Set TT2 34 Pieces
6/9	TTD01	Storage Tray TT2 8 Compartments
6/9	TTX01	Storage Tray TTX4 6 Compartments
7/9	TTNR81	Nutsert Gun Set TT1 81 Pieces
7/9	TTHR81	Rivet Gun Set TT1 81 Pieces
7/9	TTID20	1/2" Impact Driver Set TT1 20 Pieces
7/9	TTHP08	Hook & Pin Wrench Set TT1 8 Pieces
7/9	TTXPB3	Pry Bar Set Roll/Heel TTX4 3 Pieces
9/9	TTOS16	Oil Service Set TT1 16 Pieces
9/9	TTSN11	Extractor & Nut Splitter Set TT1 11 Pieces
9/9	TT804	Puller Set TT1 4 Pieces
9/9	TTHC03	Hose Clamp Set TT1 3 Pieces
9/9	TTXPB3A	Pry Bar Set TTX4 3 Pieces

Item ID: TCMONSTER01

TT SERIES



MONSTER™

53" PRO MONSTER TT TOOL KIT 1185 PIECES

- A complete tool kit covering the requirements of most users
- All the tools are laid out in individual tool trays using the TengTools Get Organised system
- Easy to see if any tools have been mislaid or lost helping to prevent leaving them with the work piece
- Supplied in the TengTools double width TC810N 10 drawer top box and the TCW809N 9 drawer 53" wide roller cabinet

- 19 Drawer**
- 53" Wide Cabinet**
- Heavy Gauge Steel**
- 5-Step Rust Protection**
- 6" Castor Wheels with Brakes**
- 3 Step Ball Bearing Slides**
- 1185 Pieces**
- 318.5 kg**
- Comfort Grip Handle**
- Combination Lock**

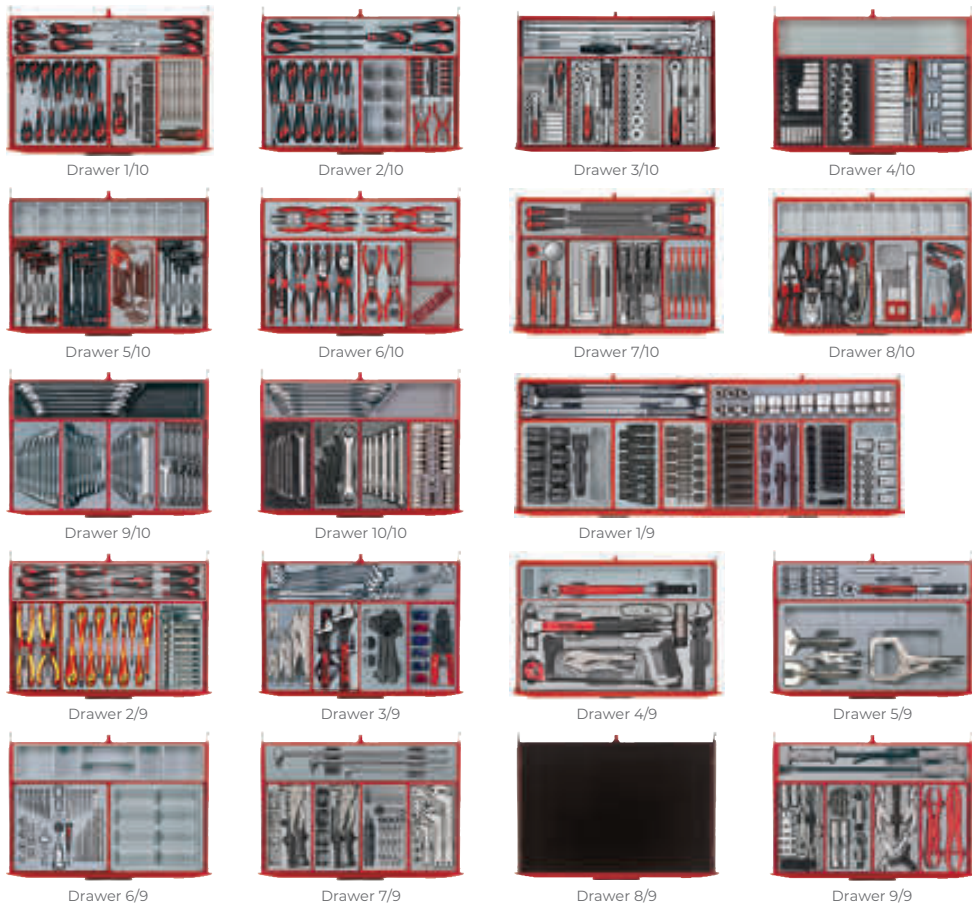

Drawer	Item ID	Description
Storage	TC810N	Tool Box Top Box 10 Drawer
	TCW809N	Tool Box Roller Cabinet 9 Drawer 53in
1/10	TTD914N	Screwdriver Set Mixed TT2 14 Pieces
1/10	TTMD74	Ratcheting Screwdriver Bit Set TT1 74 Pieces
1/10	TTMD12D	Screwdriver Blade Set Mixed TT1 12 Pieces
1/10	TTX918N	Screwdriver Set Flat & PH TTX4 8 Pieces
2/10	TTD912TXN	Screwdriver Set TX TT2 12 Pieces
2/10	TTM116	Mini Pliers & Screwdriver Set TT1 16 Pieces
2/10	TT01	Storage Tray TT1 7 Compartments
2/10	TTXMDTN	Power Through Screwdriver Set TTX4 5 Pieces
3/10	TT1435	1/4" Socket Set 6 pt TT1 35 Pieces
3/10	TT3819	3/8" Socket Set 6 pt TT1 19 Pieces
3/10	TT1205	1/2" Ratchet & Accessories Set TT1 5 Pieces
3/10	TT1217	1/2" Socket Set 12 pt TT1 17 Pieces
3/10	TTXEXT13	Extension Bars Set TTX4 13 Pieces
4/10	TTAF32	1/4" & 3/8" Socket Set AF 6 pt TT1 32 Pieces
4/10	TT1215AF	1/2" Socket Set 12 pt AF TT1 15 Pieces
4/10	TT1211	1/2" Socket Set 12 pt TT1 11 Pieces
4/10	TT3816	3/8" Socket Set 6 pt TT1 16 Pieces
4/10	TTX00	Storage Tray TTX4 1 Compartment
5/10	TTHEX7	T-Handle Ball Point Hex Key Set TT1 7 Pieces
5/10	TTHEX7AF	T-Handle Hex Key Set AF TT1 7 Pieces
5/10	TTHT28	Ball Point Hex & TX Key Set TT1 28 Pieces
5/10	TTTX7	T-Handle TX/TPX Key Set TT1 7 Pieces
5/10	TTX03	Storage Tray TTX4 8 Compartments
6/10	TTD441-T	Plier Set TPR Grip TT2 8 Pieces
6/10	TT474-7	Circlip Plier Set 19-60 mm TT1 4 Pieces
6/10	TT00	Storage Tray With Tool Holder TT1
6/10	TTX474-9	Circlip Plier Set 40-100 mm TTX4 4 Pieces
7/10	TTTM03	Inspection Set TT1 3 Pieces
7/10	TTBM	Measuring Tool Set TT1 4 Pieces
7/10	TTSR04	Scraper Set TT1 4 Pieces
7/10	TTNF12	Needle File Set TT1 12 Pieces
7/10	TTXF05	Hand File Set TTX4 5 Pieces
8/10	TTDCT05	Cutting Tool Set TT2 5 Pieces
8/10	TTK40	Knife Set TT1 40 Pieces
8/10	TTPC09	Punsch & Chisel Set TT1 9 Pieces
8/10	TTX03	Storage Tray TTX4 8 Compartments
9/10	TT1236	Combination Spanner Set TT1 12 Pieces
9/10	TT6508R	Ratcheting Spanner Set R TT1 8 Pieces
9/10	TT6208	Double Open Ended Spanner Set TT1 8 Pieces
9/10	TT6010M	Stubby Combination Spanner Set TT1 10 Pieces
9/10	TTX2032	Combination Spanner Set TTX4 7 Pieces

Drawer	Item ID	Description
10/10	TTX2640	Combination Spanner Set AF TTX4 7 Pieces
10/10	TT3592	Combination Spanner Set AF TT1 8 Pieces
10/10	TTRORS	Ratcheting Ring Spanner Set TT1 6 Pieces
10/10	TT6506	Double Flex Wrench Set TT1 6 Pieces
10/10	TTBS35	1/4" & 3/8" Bit Socket Set TT1 35 Pieces
1/9	TTBE18	Stud Extractor Set TT1 18 Pieces
1/9	TT9015HX	3/8" & 1/2" Hex Impact Skt Set DIN TT1 15 Pieces
1/9	TT9024	1/4" & 3/8" Impact Skt Set ANSI TT1 24 Pieces
1/9	TT9212TX	1/2" TX Impact Socket Set DIN TT1 12 Pieces
1/9	TT9207	1/2" Impact Accessories Set DIN TT1 11 Pieces
1/9	TT9116N	1/2" Impact Socket Set ANSI TT1 16 Pieces
1/9	TTX3404	3/4" Ratchet & Accessories Set TTX4 4 Pieces
1/9	TTD9416	3/4" Impact Socket Set DIN TT2 12 Pieces
2/9	TTV440	Insulated Plier Set TT1 4 Pieces
2/9	TTDV910N	Insulated Screwdriver Set Mixed TT2 6 Pieces
2/9	TTHEX23	1/2" Hex Bit Socket Set TT1 23 Pieces
2/9	TTXND	Nut Driver Set TTX4 9 Pieces
3/9	TTVG05	Power Grip Plier Set TT1 5 Pieces
3/9	TTADJ04	Adjustable Wrench Set TT1 4 Pieces
3/9	TTCP121	Crimping Plier Set TT1 121 Pieces
3/9	TTCP04	Crimping Plier Set TT1 4 Pieces
3/9	TTX6311	Double Ring Spanner Set TTX4 11 Pieces
4/9	TTPS09	General Tool Set BP TT4 9 Pieces
4/9	TTX1292	1/2" Torque Wrench 40-210 Nm TTX4
5/9	TTSP0C	Power Grip Plier Set TT4 4 Pieces
5/9	TTX3892	3/8" Torque Wrench Set TTX4 22 Pieces
6/9	TTDTD34	Tap and Die Set TT2 34 Pieces
6/9	TTD01	Storage Tray TT2 8 Compartments
6/9	TTX01	Storage Tray TTX4 6 Compartments
7/9	TTNR81	Nutsert Gun Set TT1 81 Pieces
7/9	TTHR81	Rivet Gun Set TT1 81 Pieces
7/9	TTID20	1/2" Impact Driver Set TT1 20 Pieces
7/9	TTHP08	Hook & Pin Wrench Set TT1 8 Pieces
7/9	TTXPB3	Pry Bar Set Roll/Heel TTX4 3 Pieces
9/9	TTOS16	Oil Service Set TT1 16 Pieces
9/9	TTSN11	Extractor & Nut Splitter Set TT1 11 Pieces
9/9	TT804	Puller Set TT1 4 Pieces
9/9	TTHC03	Hose Clamp Set TT1 3 Pieces
9/9	TTXPB3A	Pry Bar Set TTX4 3 Pieces

Item ID: TCMONSTER02

NEW

TT SERIES



37" PRO STACK TT TOOL KIT 1034 PIECES

- A complete tool kit covering the requirements of most users
- All the tools are laid out in individual tool trays using the TengTools Get Organised system
- Easy to see if any tools have been mislaid or lost helping to prevent leaving them with the work piece
- The kit contains 71 individual tool trays containing 1034 individual pieces
- Supplied in our famous extra wide TCW207N 7 drawer 37" wide roller cabinet topped with our new TC205NF 5 drawer top box
- All in TengTools red with the distinctive TengTools eyes logo on the drop front on the top box and on the bottom drawer on the cabinet

- 12 Drawer**
- 37" Wide Cabinet**
- Heavy Gauge Steel**
- 5-Step Rust Protection**
- 5" Castor Wheels with Brakes**
- 3 Step Ball Bearing Slides**
- Comfort Grip Handle**
- Combination Lock**

1034 Pieces 231.7 kg



Drawer 1/5



Drawer 2/5



Drawer 3/5



Drawer 4/5



Drawer 5/5



Drawer 1/7



Drawer 2/7



Drawer 3/7



Drawer 4/7



Drawer 5/7



Drawer 6/7



Drawer 7/7

Drawer	Item ID	Description
Storage	TC205NF	Tool Box 37in 5 Drawer
	TCW207N	Tool Box Roller Cabinet 37in 7 Drawer
1/5	TTXEXT13	Extension Bars Set TTX4 13 Pieces
1/5	TTZ01	Storage Tray TTX2 6 Compartments
1/5	TT1435	1/4" Socket Set 6 pt TT1 35 Pieces
1/5	TT3819	3/8" Socket Set 6 pt TT1 19 Pieces
1/5	TT1217	1/2" Socket Set 12 pt TT1 17 Pieces
1/5	TT1205	1/2" Ratchet & Accessories Set TT1 5 Pieces
1/5	TTTX30	3/8" TX Bit Socket Set TT1 30 Pieces
1/5	TTTXH15	1/2" Hex & TX Bit Socket Set TT1 15 Pieces
2/5	TTX474-9E	Circlip Plier Set PRO 40-100 mm TTX4 4 Pieces
2/5	TTZVG03	Power Grip Plier Set TTX2 3 Pieces
2/5	TT474-5E	Circlip Plier Set PRO 10-25 mm TT1 4 Pieces
2/5	TT474-7E	Circlip Plier Set PRO 19-60 mm TT1 4 Pieces
2/5	TTDCT05	Cutting Tool Set TT2 5 Pieces
2/5	TTD441	Plier Set Vinyl Grip TT2 8 Pieces
3/5	TTX918N	Screwdriver Set Flat & PH TTX4 8 Pieces
3/5	TTZ01	Storage Tray TTX2 6 Compartments
3/5	TT917N	Screwdriver Set Mixed TT1 7 Pieces
3/5	TT917TXN	Screwdriver Set TX & TPX TT1 7 Pieces
3/5	TTMD74	Ratcheting Screwdriver Bit Set TT1 74 Pieces
3/5	TTSR04	Scraper Set TT1 4 Pieces
3/5	TTHR81	Rivet Gun Set TT1 81 Pieces
3/5	TTNR81	Nutsert Gun Set TT1 81 Pieces
4/5	TTX2032	Combination Spanner Set TTX4 7 Pieces
4/5	TTZ01	Storage Tray TTX2 6 Compartments
4/5	TT1236	Combination Spanner Set TT1 12 Pieces
4/5	TT6010M	Stubby Combination Spanner Set TT1 10 Pieces
4/5	TT6508R	Ratcheting Spanner Set R TT1 8 Pieces
4/5	TT6506	Double Flex Wrench Set TT1 6 Pieces
4/5	TTHP08	Hook & Pin Wrench Set TT1 8 Pieces
4/5	TT6508RF	Ratcheting Spanner Set RF TT1 8 Pieces
5/5	TTX2640	Combination Spanner Set AF TTX4 7 Pieces
5/5	TTZ01	Storage Tray TTX2 6 Compartments
5/5	TT1215AF	1/2" Socket Set 12 pt AF TT1 15 Pieces
5/5	TTAF32	1/4" & 3/8" Socket Set AF 6 pt TT1 32 Pieces
5/5	TT3592	Combination Spanner Set AF TT1 8 Pieces
5/5	TTHEX7	T-Handle Ball Point Hex Key Set TT1 7 Pieces
5/5	TTTX7	T-Handle TX/TPX Key Set TT1 7 Pieces
5/5	TTHEX7AF	T-Handle Hex Key Set AF TT1 7 Pieces
1/7	TTX3892	3/8" Torque Wrench Set TTX4 22 Pieces
1/7	TTZ01	Storage Tray TTX2 6 Compartments
1/7	TT9116N	1/2" Impact Socket Set ANSI TT1 16 Pieces

Drawer	Item ID	Description
1/7	TT9015HX	3/8" & 1/2" Hex Impact Skt Set DIN TT1 15 Pieces
1/7	TTHEX23	1/2" Hex Bit Socket Set TT1 23 Pieces
1/7	TTTX23	1/2" TX Bit Socket Set TT1 23 Pieces
1/7	TTID20	1/2" Impact Driver Set TT1 20 Pieces
1/7	TTID19	1/4" Impact Driver Set TT1 19 Pieces
2/7	TTX1292	1/2" Torque Wrench 40-210 Nm TTX4
2/7	TTZ01	Storage Tray TTX2 6 Compartments
2/7	TTV907N	Insulated Screwdriver Set Mixed TT1 7 Pieces
2/7	TTV440	Insulated Plier Set TT1 4 Pieces
2/7	TTPS09	General Tool Set BP TT4 9 Pieces
3/7	TTXMDTN	Power Through Screwdriver Set TTX4 5 Pieces
3/7	TTZ01	Storage Tray TTX2 6 Compartments
3/7	TTTM03	Inspection Set TT1 3 Pieces
3/7	TTSD38	Torque Screwdriver Set TT1 38 Pieces
3/7	TTSN11	Extractor & Nut Splitter Set TT1 11 Pieces
3/7	TTTD17	Tap and Die Set TT1 17 Pieces
3/7	TTM116	Mini Pliers & Screwdriver Set TT1 16 Pieces
3/7	TT804	Puller Set TT1 4 Pieces
4/7	TTXND	Nut Driver Set TTX4 9 Pieces
4/7	TTX6311	Double Ring Spanner Set TTX4 11 Pieces
4/7	TTXF05	Hand File Set TTX4 5 Pieces
4/7	TTZ01	Storage Tray TTX2 6 Compartments
4/7	TTCP121	Crimping Plier Set TT1 121 Pieces
4/7	TTHC03	Hose Clamp Set TT1 3 Pieces
7/7	TTX3404	3/4" Ratchet & Accessories Set TTX4 4 Pieces
7/7	TTX3414	3/4" Socket Set 6 pt TTX4 14 Pieces
7/7	TTXPB3A	Pry Bar SetTTX4 3 Pieces
7/7	TTZ01	Storage Tray TTX2 6 Compartments
7/7	TTOS16	Oil Service Set TT1 16 Pieces
7/7	TTPC09	Punsch & Chisel Set TT1 9 Pieces

Item ID: **TCMM1034N**



TT SERIES

MEGA MASTER™

26" PRO MEGA MASTER TT TOOL KIT

- A complete tool kit covering the requirements of most users
- All the tools are laid out in individual tool trays using the TengTools Get Organised system
- Easy to see if any tools have been mislaid or lost helping to prevent leaving them with the work piece
- Supplied in a red TengTools 19 drawer stack system with a top box, middle box and roller cabinet
- Distinctive TengTools eyes logo on the drop front of the top box

- 19 Drawers**
- 26" Wide Cabinet**
- Heavy Gauge Steel**
- 5-Step Rust Protection**
- 5" Castor Wheels with Brakes**
- 3 Step Ball Bearing Slides**
- Comfort Grip Handle**
- Combination Lock**

1001 Pieces 220 kg



Drawer 1, 2, 3/6



Drawer 4/6



Drawer 5/6



Drawer 6/6



Drawer 1/3



Drawer 2/3



Drawer 3/3



Drawer 1/10



Drawer 2/10



Drawer 3/10



Drawer 4/10



Drawer 5/10



Drawer 6/10



Drawer 7/10



Drawer 8/10



Drawer 9/10



Drawer 10/10

Drawer	Item ID	Description
Storage	TC806NF	Tool Box Top Box 6 Drawer
	TC803N	Tool Box Middle Box 3 Drawer
	TCW810N	Tool Box Roller Cabinet 10 Drawer
1/6	TM708	Mini Screwdriver Set Mixed 8 Pieces
1/6	1479MM	Ball Point Hex Key Set 9 Pieces
1/6	1479AF	Ball Point Hex Key Set AF 9 Pieces
1/6	1479TX	TX Key Set 9 Pieces
4/6	TTHX7	T-Handle Ball Point Hex Key Set TTI 7 Pieces
4/6	TTR81	Nutsert Gun Set TTI 81 Pieces
4/6	TTTX7	T-Handle TX/TPX Key Set TTI 7 Pieces
4/6	TTHR81	Rivet Gun Set TTI 81 Pieces
5/6	TTI236	Combination Spanner Set TTI 12 Pieces
5/6	TTALU	Clip Rail Set TTI 32 Pieces
5/6	TTTM03	Inspection Set TTI 3 Pieces
5/6	TT6208	Double Open Ended Spanner Set TTI 8 Pieces
6/6	TTPS09	General Tool Set BP TT4 9 Pieces
1/3	TTPC09	Punch & Chisel Set TTI 9 Pieces
1/3	TTID20	1/2" Impact Driver Set TTI 20 Pieces
1/3	TTSR04	Scraper Set TTI 4 Pieces
1/3	TT00	Storage Tray With Tool Holder TTI
2/3	TTHP08	Hook & Pin Wrench Set TTI 8 Pieces
2/3	TT6506	Double Flex Wrench Set TTI 6 Pieces
2/3	TT6010M	Stubby Combination Spanner Set TTI 10 Pieces
2/3	TT3592	Combination Spanner Set AF TTI 8 Pieces
3/3	TTXPB3	Pry Bar Set Roll/Heel TTX4 3 Pieces
3/3	TTX6311	Double Ring Spanner Set TTX4 11 Pieces
1/10	TTXEXT13	Extension Bars Set TTX4 13 Pieces
1/10	TT1205	1/2" Ratchet & Accessories Set TTI 5 Pieces
1/10	TT1435	1/4" Socket Set 6 pt TTI 35 Pieces
1/10	TT3819	3/8" Socket Set 6 pt TTI 19 Pieces
1/10	TT1217	1/2" Socket Set 12 pt TTI 17 Pieces
2/10	TTTX23	1/2" TX Bit Socket Set TTI 23 Pieces
2/10	TTHX23	1/2" Hex Bit Socket Set TTI 23 Pieces
2/10	TTALU	Clip Rail Set TTI 32 Pieces
2/10	TTXND	Nut Driver Set TTX4 9 Pieces
2/10	TT9116N	1/2" Impact Socket Set ANSI TTI 16 Pieces
3/10	TTX918N	Screwdriver Set Flat & PH TTX4 8 Pieces
3/10	TT917N	Screwdriver Set Mixed TTI 7 Pieces
3/10	TT917TXN	Screwdriver Set TX & TPX TTI 7 Pieces
3/10	TTMD74	Ratcheting Screwdriver Bit Set TTI 74 Pieces
3/10	TTMI16	Mini Pliers & Screwdriver Set TTI 16 Pieces
4/10	TTX474-9	Circlip Plier Set 40-100 mm TTX4 4 Pieces

Drawer	Item ID	Description
4/10	TT440-T	Plier Set TPR Grip TTI 4 Pieces
4/10	TT474-7	Circlip Plier Set 19-60 mm TTI 4 Pieces
4/10	TT474-5	Circlip Plier Set 10-25 mm TTI 4 Pieces
4/10	TTHC03	Hose Clamp Set TTI 3 Pieces
5/10	TTX1292	1/2" Torque Wrench 40-210 Nm TTX4
5/10	TTV440	Insulated Plier Set TTI 4 Pieces
5/10	TTCP121	Crimping Plier Set TTI 121 Pieces
5/10	TTV907N	Insulated Screwdriver Set Mixed TTI 7 Pieces
5/10	TT01	Storage Tray TTI 7 Compartments
6/10	TTX01	Storage Tray TTX4 6 Compartments
6/10	TT804	Puller Set TTI 4 Pieces
6/10	TTOS16	Oil Service Set TTI 16 Pieces
6/10	TTSN11	Extractor & Nut Splitter Set TTI 11 Pieces
6/10	TTTD17	Tap and Die Set TTI 17 Pieces
7/10	TTX2032	Combination Spanner Set TTX4 7 Pieces
7/10	TTX3892	3/8" Torque Wrench Set TTX4 22 Pieces
7/10	TTXPB3A	Pry Bar Set TTX4 3 Pieces
8/10	TTXMDN	Nut Driver Set TTX4 9 Pieces OLD
8/10	TTSPSG	Power Grip Plier Set TT4 4 Pieces
9/10	TTX2640	Combination Spanner Set AF TTX4 7 Pieces
9/10	TTTXH15	1/2" Hex & TX Bit Socket Set TTI 15 Pieces
9/10	TTI215AF	1/2" Socket Set 12 pt AF TTI 15 Pieces
9/10	TTAF32	1/4" & 3/8" Socket Set AF 6 pt TTI 32 Pieces
9/10	TTTX30	3/8" TX Bit Socket Set TTI 30 Pieces
10/10	TTX3404	3/4" Ratchet & Accessories Set TTX4 4 Pieces
10/10	TTX3414	3/4" Socket Set 6 pt TTX4 14 Pieces
-	ABS-TOP	ABS Top for Roller Cabinet
-	580	Magnetic Bits Tray

Item ID: **TCMM1001N**

TT SERIES



MEGA MASTER™

26" PRO MEGA MASTER TT TOOL KIT

- 1,001 piece Mega Master tool kit
- A complete tool kit covering the requirements of most users
- All the tools are laid out in individual tool trays using the TengTools Get Organised system
- Easy to see if any tools have been mislaid or lost helping to prevent leaving them with the work piece
- Supplied in a black TengTools 19 drawer stack system with a top box, middle box and roller cabinet all finished in a high gloss black

- 19 Drawer**
- 26" Wide Cabinet**
- Heavy Gauge Steel**
- 5-Step Rust Protection**
- 5" Castor Wheels with Brakes**
- 3 Step Ball Bearing Slides**
- Comfort Grip Handle**
- Combination Lock**

1001 Pieces 220 kg



Drawer 4/6



Drawer 5/6



Drawer 6/6



Drawer 1/3



Drawer 2/3



Drawer 3/3



Drawer 1/10



Drawer 2/10



Drawer 3/10



Drawer 4/10



Drawer 5/10



Drawer 6/10



Drawer 7/10



Drawer 8/10



Drawer 9/10



Drawer 10/10

Drawer	Item ID	Description
Storage	TC806NBK	Tool Box Top Box 6 Drawer Black
	TC803NBK	Tool Box Middle Box 3 Drawer Black
	TCW810NBK	Tool Box Roller Cab 10 Drawer Black
1/6	TM708	Mini Screwdriver Set Mixed 8 Pieces
1/6	1479MM	Ball Point Hex Key Set 9 Pieces
1/6	1479AF	Ball Point Hex Key Set AF 9 Pieces
1/6	1479TX	TX Key Set 9 Pieces
4/6	TTHX7	T-Handle Ball Point Hex Key Set TTI 7 Pieces
4/6	TNR81	Nutsert Gun Set TTI 81 Pieces
4/6	TTX7	T-Handle TX/TPX Key Set TTI 7 Pieces
4/6	TTHR81	Rivet Gun Set TTI 81 Pieces
5/6	TTI236	Combination Spanner Set TTI 12 Pieces
5/6	TTALU	Clip Rail Set TTI 32 Pieces
5/6	TTTM03	Inspection Set TTI 3 Pieces
5/6	TT6208	Double Open Ended Spanner Set TTI 8 Pieces
6/6	TTPS09	General Tool Set BP TT4 9 Pieces
1/3	TTPC09	Punch & Chisel Set TTI 9 Pieces
1/3	TTID20	1/2" Impact Driver Set TTI 20 Pieces
1/3	TTSR04	Scraper Set TTI 4 Pieces
1/3	TT00	Storage Tray With Tool Holder TTI
2/3	TTHP08	Hook & Pin Wrench Set TTI 8 Pieces
2/3	TT6506	Double Flex Wrench Set TTI 6 Pieces
2/3	TT6010M	Stubby Combination Spanner Set TTI 10 Pieces
2/3	TT3592	Combination Spanner Set AF TTI 8 Pieces
3/3	TTXPB3	Pry Bar Set Roll/Heel TTX4 3 Pieces
3/3	TTX6311	Double Ring Spanner Set TTX4 11 Pieces
1/10	TTXEXT13	Extension Bars Set TTX4 13 Pieces
1/10	TT1205	1/2" Ratchet & Accessories Set TTI 5 Pieces
1/10	TT1435	1/4" Socket Set 6 pt TTI 35 Pieces
1/10	TT3819	3/8" Socket Set 6 pt TTI 19 Pieces
1/10	TT1217	1/2" Socket Set 12 pt TTI 17 Pieces
2/10	TTTX23	1/2" TX Bit Socket Set TTI 23 Pieces
2/10	TTHX23	1/2" Hex Bit Socket Set TTI 23 Pieces
2/10	TTALU	Clip Rail Set TTI 32 Pieces
2/10	TTXMDTN	Power Through Screwdriver Set TTX4 5 Pieces
2/10	TT9116N	1/2" Impact Socket Set ANSI TTI 16 Pieces
3/10	TTX918N	Screwdriver Set Flat & PH TTX4 8 Pieces
3/10	TT917N	Screwdriver Set Mixed TTI 7 Pieces
3/10	TT917TXN	Screwdriver Set TX & TPX TTI 7 Pieces
3/10	TTMD74	Ratcheting Screwdriver Bit Set TTI 74 Pieces
3/10	TTM116	Mini Pliers & Screwdriver Set TTI 16 Pieces
4/10	TTX474-9	Circlip Plier Set 40-100 mm TTX4 4 Pieces

Drawer	Item ID	Description
4/10	TT440-T	Plier Set TPR Grip TTI 4 Pieces
4/10	TT474-7	Circlip Plier Set 19-60 mm TTI 4 Pieces
4/10	TT474-5	Circlip Plier Set 10-25 mm TTI 4 Pieces
4/10	TTHC03	Hose Clamp Set TTI 3 Pieces
5/10	TTX1292	1/2" Torque Wrench 40-210 Nm TTX4
5/10	TTV440	Insulated Plier Set TTI 4 Pieces
5/10	TTCP121	Crimping Plier Set TTI 121 Pieces
5/10	TTV907N	Insulated Screwdriver Set Mixed TTI 7 Pieces
5/10	TT01	Storage Tray TTI 7 Compartments
6/10	TTX01	Storage Tray TTX4 6 Compartments
6/10	TT804	Puller Set TTI 4 Pieces
6/10	TTOS16	Oil Service Set TTI 16 Pieces
6/10	TTSN11	Extractor & Nut Splitter Set TTI 11 Pieces
6/10	TTTD17	Tap and Die Set TTI 17 Pieces
7/10	TTX2032	Combination Spanner Set TTX4 7 Pieces
7/10	TTX3892	3/8" Torque Wrench Set TTX4 22 Pieces
7/10	TTXPB3A	Pry Bar Set TTX4 3 Pieces
8/10	TTXND	Nut Driver Set TTX4 9 Pieces
8/10	TTSPSG	Power Grip Plier Set TT4 4 Pieces
9/10	TTX2640	Combination Spanner Set AF TTX4 7 Pieces
9/10	TTTXH15	1/2" Hex & TX Bit Socket Set TTI 15 Pieces
9/10	TTI215AF	1/2" Socket Set 12 pt AF TTI 15 Pieces
9/10	TTAF32	1/4" & 3/8" Socket Set AF 6 pt TTI 32 Pieces
9/10	TTTX30	3/8" TX Bit Socket Set TTI 30 Pieces
10/10	TTX3404	3/4" Ratchet & Accessories Set TTX4 4 Pieces
10/10	TTX3414	3/4" Socket Set 6 pt TTX4 14 Pieces
-	ABS-TOP	ABS Top for Roller Cabinet
-	580	Magnetic Bits Tray

Item ID: **TCMM1001BK**

A Personalised Tool Box Sticker

This is now available to you through your local stockist. Provide an image that you would like to use and we will customise your tool kit for you. Images need to be supplied as high resolution jpeg, PDF, or a vector format.

Item ID: **TCMM1001P**

TT SERIES



26" PRO STACK TT TOOL KIT 1055 PIECES RED

- A complete tool kit covering the requirements of most users
- All the tools are laid out in individual tool trays using the TengTools Get Organised system
- Easy to see if any tools have been mislaid or lost helping to prevent leaving them with the work piece
- Supplied in a red TengTools 16 drawer stack system with a top box, middle box and roller cabinet with the distinctive TengTools eyes logo on the drop front of the top box

- 16 Drawer**
- 26" Wide Cabinet**
- Heavy Gauge Steel**
- 5-Step Rust Protection**
- 5" Castor Wheels with Brakes**
- 3 Step Ball Bearing Slides**
- Comfort Grip Handle**
- Combination Lock**

1055 Pieces 170.3 kg



Side Panel



Drawer 1, 2, 3/6



Drawer 4/6



Drawer 5/6



Drawer 6/6



Drawer 1/3



Drawer 2/3



Drawer 3/3

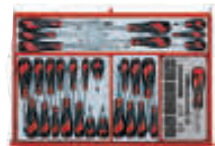

Drawer 1/7



Drawer 2/7



Drawer 3/7



Drawer 4/7



Drawer 5/7



Drawer 6/7



Drawer 7/7

Drawer	Item ID	Description
Storage	TC806NF	Tool Box Top Box 6 Drawer
	TC803N	Tool Box Middle Box 3 Drawer
	TCW807N	Tool Box Roller Cabinet 7 Drawer
	TCW-SP01	Side Panel
	TCW-HK10	Tool Hooks
2/6	1476NTX1	Folding Ball Point TX Key Set 8 Pieces
2/6	1477NX	Folding Key Set Mixed 8 Pieces
2/6	587H	Magnifying Glass with LED
4/6	TT1435	1/4" Socket Set 6 pt TTI 35 Pieces
4/6	TT3819	3/8" Socket Set 6 pt TTI 19 Pieces
4/6	TT1218	1/2" Socket Set 12 pt TTI 118 Pieces
4/6	TT1211	1/2" Socket Set 12 pt TTI 11 Pieces
5/6	TT1236	Combination Spanner Set TTI 12 Pieces
5/6	TT6010M	Stubby Combination Spanner Set TTI 10 Pieces
5/6	TT6508RS	Ratcheting Spanner Set RS TTI 8 Pieces
5/6	TTADJ04	Adjustable Wrench Set TTI 4 Pieces
6/6	TTHEX7	T-Handle Ball Point Hex Key Set TTI 7 Pieces
6/6	TTTX7	T-Handle TX/TPX Key Set TTI 7 Pieces
6/6	TTHT28	Ball Point Hex & TX Key Set TTI 28 Pieces
6/6	TT804	Puller Set TTI 4 Pieces
1/3	TTD441-T	Plier Set TPR Grip TT2 8 Pieces
1/3	TT474-7	Circlip Plier Set 19-60 mm TTI 4 Pieces
1/3	TTM116	Mini Pliers & Screwdriver Set TTI 16 Pieces
2/3	TTCP04	Crimping Plier Set TTI 4 Pieces
2/3	TTCP121	Crimping Plier Set TTI 121 Pieces
2/3	TTV440	Insulated Plier Set TTI 4 Pieces
2/3	TTV907N	Insulated Screwdriver Set Mixed TTI 7 Pieces
3/3	TTTF10	Flaring Tool Set TTI 10 Pieces
3/3	TTK40	Knife Set TTI 40 Pieces
3/3	TTDCT05	Cutting Tool Set TT2 5 Pieces
1/7	TTD914N	Screwdriver Set Mixed TT2 14 Pieces
1/7	TT917TXN	Screwdriver Set TX & TPX TTI 7 Pieces
1/7	TTMD74	Ratcheting Screwdriver Bit Set TTI 74 Pieces
1/7	TTX918N	Screwdriver Set Flat & PH TTX4 8 Pieces
2/7	TTHR81	Rivet Gun Set TTI 81 Pieces
2/7	TTNR81	Nutsert Gun Set TTI 81 Pieces
2/7	TTSD39	Torque Screwdriver Set TTI 39 Pieces
2/7	TTBE18	Stud Extractor Set TTI 18 Pieces
2/7	TTX1292	1/2" Torque Wrench 40-210 Nm TTX4
3/7	TTVG05	Power Grip Plier Set TTI 5 Pieces

Drawer	Item ID	Description
3/7	TTID20	1/2" Impact Driver Set TTI 20 Pieces
3/7	TTPC09	Punch & Chisel Set TTI 9 Pieces
3/7	TTNF12	Needle File Set TTI 12 Pieces
3/7	TTXEXT13	Extension Bars Set TTX4 13 Pieces
4/7	TTAF32	1/4" & 3/8" Socket Set AF 6 pt TTI 32 Pieces
4/7	TT1215AF	1/2" Socket Set 12 pt AF TTI 15 Pieces
4/7	TTBM	Measuring Tool Set TTI 4 Pieces
4/7	TTM08	inspection Set TTI 8 Pieces
4/7	TTXTB09	3/8" Long T Bar Socket Set TTX4 9 Pieces
5/7	TTTXH15	1/2" Long Hex & TX Bit Socket Set TTI 15 Pieces
5/7	TTTX30	3/8" TX Bit Socket Set TTI 30 Pieces
5/7	TTRS15	1/2" Ribe & XZN Bit Socket Set TTI 15 Pieces
5/7	TTBS35	1/4" & 3/8" Bit Socket Set TTI 35 Pieces
5/7	TTX2032	Combination Spanner Set TTX4 7 Pieces
6/7	TT9024	1/4" & 3/8" Impact Skt Set ANSI TTI 24 Pieces
6/7	TT9207	1/2" Impact Accessories Set DIN TTI 11 Pieces
6/7	TT9116N	1/2" Impact Socket Set ANSI TTI 16 Pieces
6/7	TTTS08	1/2" Torque Sticks & Wheel Nut Set TTI 8 Pieces
6/7	TTXPB3	Pry Bar Set Roll/Heel TTX4 3 Pieces
7/7	583M	Magnetic Bracelet
7/7	TM149	Hook & Pick Set 4 Pieces
7/7	9850	Circuit Tester
7/7	DB034	Drill Bit Set 1.0-13.0 mm 34 Pieces
-	580	Magnetic Bits Tray

Item ID: **TCMM1055N**

TT SERIES



26" PRO STACK TT TOOL KIT 715 PIECES RED

- A complete tool kit covering the requirements of most users
- The tools are laid out in individual tool trays using the TengTools Get Organised system
- Larger tools are fitted to the removable free standing side plate for easier storage and use
- Easy to see if any tools have been mislaid or lost helping to prevent leaving them with the work piece
- Supplied in a red TengTools 19 drawer stack system with a top box, middle box and roller cabinet with the distinctive TengTools eyes logo on the drop front of the top box
- A comprehensive selection of tools using 11 of the available 19 drawers ensuring that space is still available to add to the kit if needed

- 19 Drawer**
- 26" Wide Cabinet**
- Heavy Gauge Steel**
- 5-Step Rust Protection**
- 5" Castor Wheels with Brakes**
- 3 Step Ball Bearing Slides**
- Comfort Grip Handle**
- Combination Lock**

715 Pieces 172.7 kg



Side Plate



Drawer 5/6



Drawer 1, 2, 3/6



Drawer 4/6

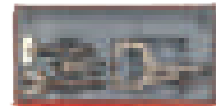

Drawer 6/6



Drawer 1/3



Drawer 2/3



Drawer 3/3



Drawer 1/10



Drawer 2/10

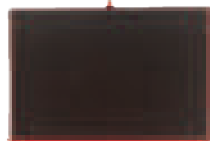

Drawer 3/10



Drawer 4/10

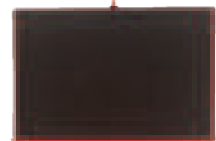

Drawer 5/10

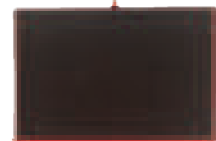

Drawer 6/10



Drawer 7/10



Drawer 8/10



Drawer 9/10

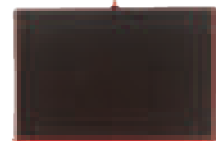

Drawer 10/10

Drawer	Item ID	Description
Storage	TC806NF	Tool Box Top Box 6 Drawer
	TC803N	Tool Box Middle Box 3 Drawer
	TCW810N	Tool Box Roller Cabinet 10 Drawer
	TCW-SP01	Side Panel
	TCW-HK10	Tool Hooks
4/6	TTM116	Mini Pliers & Screwdriver Set TT1 16 Pieces
4/6	TTID20	1/2" Impact Driver Set TT1 20 Pieces
4/6	TTPC09	Punch & Chisel Set TT1 9 Pieces
4/6	TT01	Storage Tray TT1 7 Compartments
5/6	TT917N	Screwdriver Set Mixed TT1 7 Pieces
5/6	TT440-T	Plier Set TPR Grip TT1 4 Pieces
5/6	TT917TXN	Screwdriver Set TX & TPX TT1 7 Pieces
5/6	TTMD74	Ratcheting Screwdriver Bit Set TT1 74 Pieces
6/6	TTPSPG	Power Grip Plier Set TT4 4 Pieces
1/3	TT804	Puller Set TT1 4 Pieces
1/3	TTNR81	Nutsert Gun Set TT1 81 Pieces
1/3	TTTD17	Tap and Die Set TT1 17 Pieces
1/3	TTHP08	Hook & Pin Wrench Set TT1 8 Pieces
2/3	TTHEX7	T-Handle Ball Point Hex Key Set TT1 7 Pieces
2/3	TT474-7	Circlip Plier Set 19-60 mm TT1 4 Pieces
2/3	TTTX7	T-Handle TX/TPX Key Set TT1 7 Pieces
2/3	TTHR81	Rivet Gun Set TT1 81 Pieces
3/3	TTX6311	Double Ring Spanner Set TTX4 11 Pieces
3/3	TTXPB3	Pry Bar Set Roll/Heel TTX4 3 Pieces
1/10	TTXEXT13	Extension Bars Set TTX4 13 Pieces
1/10	TT1435	1/4" Socket Set 6 pt TT1 35 Pieces
1/10	TT3819	3/8" Socket Set 6 pt TT1 19 Pieces
1/10	TT1217	1/2" Socket Set 12 pt TT1 17 Pieces
1/10	TT1205	1/2" Ratchet & Accessories Set TT1 5 Pieces
2/10	TTX1292	1/2" Torque Wrench 40-210 Nm TTX4
2/10	TT9116N	1/2" Impact Socket Set ANSI TT1 16 Pieces
2/10	TTHEX23	1/2" Hex Bit Socket Set TT1 23 Pieces
2/10	TTALU	Clip Rail Set TT1 32 Pieces
2/10	TTTX23	1/2" TX Bit Socket Set TT1 23 Pieces
7/10	TTX2032	Combination Spanner Set TTX4 7 Pieces
7/10	TT1236	Combination Spanner Set TT1 12 Pieces
7/10	TTSN11	Extractor & Nut Splitter Set TT1 11 Pieces
7/10	TTOS16	Oil Service Set TT1 16 Pieces
7/10	TTALU	Clip Rail Set TT1 32 Pieces
8/10	TTX918N	Screwdriver Set Flat & PH TTX4 8 Pieces

Drawer	Item ID	Description
8/10	TTPS09	General Tool Set BP TT4 9 Pieces
9/10	TTX2640	Combination Spanner Set AF TTX4 7 Pieces
9/10	TT3592	Combination Spanner Set AF TT1 8 Pieces
9/10	TTAF32	1/4" & 3/8" Socket Set AF 6 pt TT1 32 Pieces
9/10	TT1215AF	1/2" Socket Set 12 pt AF TT1 15 Pieces
9/10	TTTX30	3/8" TX Bit Socket Set TT1 30 Pieces

Item ID: **TCMM715N**

TT
SERIES



26" PRO STACK TT TOOL KIT 600 PIECES RED

- A complete tool kit covering the requirements of most users
- The tools are laid out in individual tool trays using the TengTools Get Organised system
- Larger tools are fitted to the removable free standing side plate for easier storage and use
- Easy to see if any tools have been mislaid or lost helping to prevent leaving them with the work piece
- Supplied in a red TengTools 16 drawer stack system with a top box, middle box and roller cabinet with the distinctive TengTools eyes logo on the drop front of the top box
- A comprehensive selection of tools using 11 of the available 16 drawers ensuring that space is still available to add to the kit if needed

- 16 Drawer**
- 26" Wide Cabinet**
- Heavy Gauge Steel**
- 5-Step Rust Protection**
- 5" Castor Wheels with Brakes**
- 3 Step Ball Bearing Slides**
- Comfort Grip Handle**
- Combination Lock**

600
Pieces 178.3 kg



Side Panel



Drawer 1, 2, 3/6



Drawer 4/6



Drawer 5/6



Drawer 6/6



Drawer 1/3



Drawer 2/3



Drawer 3/3



Drawer 1/7



Drawer 2/7



Drawer 3/7



Drawer 4/7



Drawer 5/7



Drawer 6/7



Drawer 7/7

Drawer	Item ID	Description
Storage	TC806NF	Tool Box Top Box 6 Drawer
	TC803N	Tool Box Middle Box 3 Drawer
	TCW807N	Tool Box Roller Cabinet 7 Drawer
	TCW-SP01	Side Panel
	TCW-HK10	Tool Hooks
4/6	TT1435	1/4" Socket Set 6 pt TT1 35 Pieces
4/6	TT3819	3/8" Socket Set 6 pt TT1 19 Pieces
4/6	TT1217	1/2" Socket Set 12 pt TT1 17 Pieces
4/6	TT1205	1/2" Ratchet & Accessories Set TT1 5 Pieces
5/6	TT1236	Combination Spanner Set TT1 12 Pieces
5/6	TT917N	Screwdriver Set Mixed TT1 7 Pieces
5/6	TT440	Plier Set Vinyl Grip TT1 4 Pieces
5/6	TTALU	Clip Rail Set TT1 32 Pieces
6/6	TTPS09	General Tool Set BP TT4 9 Pieces
1/3	TTXEXT13	Extension Bars Set TTX4 13 Pieces
1/3	TTX918N	Screwdriver Set Flat & PH TTX4 8 Pieces
2/3	TTOS16	Oil Service Set TT1 16 Pieces
2/3	TTM116	Mini Pliers & Screwdriver Set TT1 16 Pieces
2/3	TTHEX7	T-Handle Ball Point Hex Key Set TT1 7 Pieces
2/3	TTTX7	T-Handle TX/TPX Key Set TT1 7 Pieces
3/3	TT474-7	Circlip Plier Set 19-60 mm TT1 4 Pieces
3/3	TT917TXN	Screwdriver Set TX & TPX TT1 7 Pieces
3/3	TTHEX23	1/2" Hex Bit Socket Set TT1 23 Pieces
3/3	TTTX23	1/2" TX Bit Socket Set TT1 23 Pieces
1/7	1201	Flex Handle
1/7	1424	Hex Key Set AF 10 Pieces
1/7	1425	Hex Key Set 10 Pieces
1/7	1487	TX Key Set 7 Pieces
1/7	586	Flexible Light With Magnet
1/7	64101	Flare nut Wrench Metric
1/7	641213	Flare nut Wrench Metric
1/7	661416	Flare nut Wrench AF
1/7	705	Mini Hacksaw
1/7	9850	Circuit Tester
1/7	CALD150	Digital Caliper
1/7	ID506	5/16" Impact Driver Set 6 Pieces
1/7	MB499-7T	Wire Stripping Plier TPR Grip
1/7	MD503N	Hose Clip Driver
1/7	SPBP20	Spark Plug Boot Plier

Drawer	Item ID	Description
1/7	TRC1012	Spark Plug Thread Cleaner
1/7	TRC1418	Spark Plug Thread Cleaner
1/7	TTX2032	Combination Spanner Set TTX4 7 Pieces
1/7	TT804	Puller Set TT1 4 Pieces
1/7	TTSN11	Extractor & Nut Splitter Set TT1 11 Pieces
2/7	TTX1292	1/2" Torque Wrench 40-210 Nm TTX4
2/7	TTTD17	Tap and Die Set TT1 17 Pieces
2/7	TTPC09	Punch & Chisel Set TT1 9 Pieces
2/7	TTHR81	Rivet Gun Set TT1 81 Pieces
2/7	TT9116N	1/2" Impact Socket Set ANSI TT1 16 Pieces
3/7	TTXPB3	Pry Bar Set Roll/Heel TTX4 3 Pieces
3/7	TTPSPG	Power Grip Plier Set TT4 4 Pieces
4/7	TTX2640	Combination Spanner Set AF TTX4 7 Pieces
4/7	TT3592	Combination Spanner Set AF TT1 8 Pieces
4/7	TTAF32	1/4" & 3/8" Socket Set AF 6 pt TT1 32 Pieces
4/7	TT1215AF	1/2" Socket Set 12 pt AF TT1 15 Pieces
4/7	TTALU	Clip Rail Set TT1 32 Pieces
5/7	TTX3414	3/4" Socket Set 6 pt TTX4 14 Pieces
5/7	TTX3404	3/4" Ratchet & Accessories Set TTX4 4 Pieces
5/7	TTX34AF	3/4" Socket Set 12 pt AF TTX4 14 Pieces
Side Plate	BC424	Bolt Cutter
	MB416	Groove Joint Water Pump Plier
	PWC18	Aluminium Pipe Wrench
	4008	Adjustable Wrench
-	580	Magnetic Bits Tray
-	TC-MAG	Magnetic Tool Rail

Item ID: **TCMM600**

TT SERIES



26" PRO STACK TT TOOL KIT 479 PIECES RED

- A complete tool kit covering the requirements of most users
- The tools are laid out in individual tool trays using the TengTools Get Organised system
- Easy to see if any tools have been mislaid or lost helping to prevent leaving them with the work piece
- Supplied in a red TengTools 16 drawer stack system with a top box, middle box and roller cabinet with the distinctive TengTools eyes logo on the drop front of the top box
- A comprehensive selection of tools using 9 of the available 16 drawers ensuring that space is still available to add to the kit if needed

- 16 Drawer**
- 26" Wide Cabinet**
- Heavy Gauge Steel**
- 5-Step Rust Protection**
- 5" Castor Wheels with Brakes**
- 3 Step Ball Bearing Slides**
- Comfort Grip Handle**
- Combination Lock**

479 Pieces 138.3 kg



Side Panel



Drawer 1, 2, 3/6



Drawer 4/6



Drawer 5/6



Drawer 6/6



Drawer 1/3



Drawer 2/3



Drawer 3/3



Drawer 1/7



Drawer 2/7



Drawer 3/7



Drawer 4/7

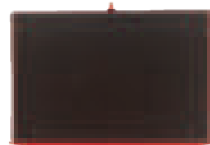

Drawer 5/7



Drawer 6/7



Drawer 7/7

Drawer	Item ID	Description
Storage	TC806NF	Tool Box Top Box 6 Drawer
	TC803N	Tool Box Middle Box 3 Drawer
	TCW807N	Tool Box Roller Cabinet 7 Drawer
	TCW-SP01	Side Panel
	TCW-HK10	Tool Hooks
4/6	TT1435	1/4" Socket Set 6 pt TT1 35 Pieces
4/6	TT3819	3/8" Socket Set 6 pt TT1 19 Pieces
4/6	TT1217	1/2" Socket Set 12 pt TT1 17 Pieces
4/6	TT1205	1/2" Ratchet & Accessories Set TT1 5 Pieces
5/6	TT1236	Combination Spanner Set TT1 12 Pieces
5/6	TT917N	Screwdriver Set Mixed TT1 7 Pieces
5/6	TT440	Plier Set Vinyl Grip TT1 4 Pieces
5/6	TTALU	Clip Rail Set TT1 32 Pieces
6/6	TTPS09	General Tool Set BP TT4 9 Pieces
1/3	TTXEXT13	Extension Bars Set TTX4 13 Pieces
1/3	TTX918N	Screwdriver Set Flat & PH TTX4 8 Pieces
2/3	TTOS16	Oil Service Set TT1 16 Pieces
2/3	TTM116	Mini Pliers & Screwdriver Set TT1 16 Pieces
2/3	TTHEX7	T-Handle Ball Point Hex Key Set TT1 7 Pieces
2/3	TTTX7	T-Handle TX/TPX Key Set TT1 7 Pieces
3/3	TT474-7	Circlip Plier Set 19-60 mm TT1 4 Pieces
3/3	TT917TXN	Screwdriver Set TX & TPX TT1 7 Pieces
3/3	TTHEX23	1/2" Hex Bit Socket Set TT1 23 Pieces
3/3	TTTX23	1/2" TX Bit Socket Set TT1 23 Pieces
1/7	1201	Flex Handle
1/7	1425	Hex Key Set 10 Pieces
1/7	1487	TX Key Set 7 Pieces
1/7	586	Flexible Light With Magnet
1/7	641011	Flare nut Wrench Metric
1/7	641213	Flare nut Wrench Metric
1/7	661416	Flare nut Wrench AF
1/7	705	Mini Hacksaw
1/7	9850	Circuit Tester
1/7	CALD150	Digital Caliper
1/7	ID506	5/16" Impact Driver Set 6 Pieces
1/7	MB499-7T	Wire Stripping Plier TPR Grip
1/7	MD503N	Hose Clip Driver
1/7	SPBP20	Spark Plug Boot Plier
1/7	TF30	Pipe Cutter 3-32mm

Drawer	Item ID	Description
1/7	TRC1012	Spark Plug Thread Cleaner
1/7	TRC1418	Spark Plug Thread Cleaner
1/7	TTX2032	Combination Spanner Set TTX4 7 Pieces
1/7	TT804	Puller Set TT1 4 Pieces
1/7	TTSN11	Extractor & Nut Splitter Set TT1 11 Pieces
2/7	TTX1292	1/2" Torque Wrench 40-210 Nm TTX4
2/7	TTTD17	Tap and Die Set TT1 17 Pieces
2/7	TTPC09	Punch & Chisel Set TT1 9 Pieces
2/7	TTHR81	Rivet Gun Set TT1 81 Pieces
2/7	TT9116N	1/2" Impact Socket Set ANSI TT1 16 Pieces
3/7	TTXPB3	Pry Bar Set Roll/Heel TTX4 3 Pieces
3/7	TTPSPG	Power Grip Plier Set TT4 4 Pieces

Item ID: **TCMM479**

TT SERIES



26" STD STACK TT TOOL KIT 569 PIECES RED

- A complete tool kit covering the requirements of most users
- The tools are laid out in individual tool trays using the TengTools Get Organised system
- Easy to see if any tools have been mislaid or lost helping to prevent leaving them with the work piece
- Supplied in a red TengTools SV style 16 drawer stack system with a top box, middle box and roller cabinet with the distinctive TengTools eyes logo on the drop front of the top box
- A comprehensive selection of tools using 9 of the available 16 drawers ensuring that space is still available to add to the kit if needed

- 16 Drawer**
- 26" Wide Cabinet**
- Heavy Gauge Steel**
- 5-Step Rust Protection**
- 5" Castor Wheels with Brakes**
- 3 Step Ball Bearing Slides**
- Key Lock**

569 Pieces 116 kg

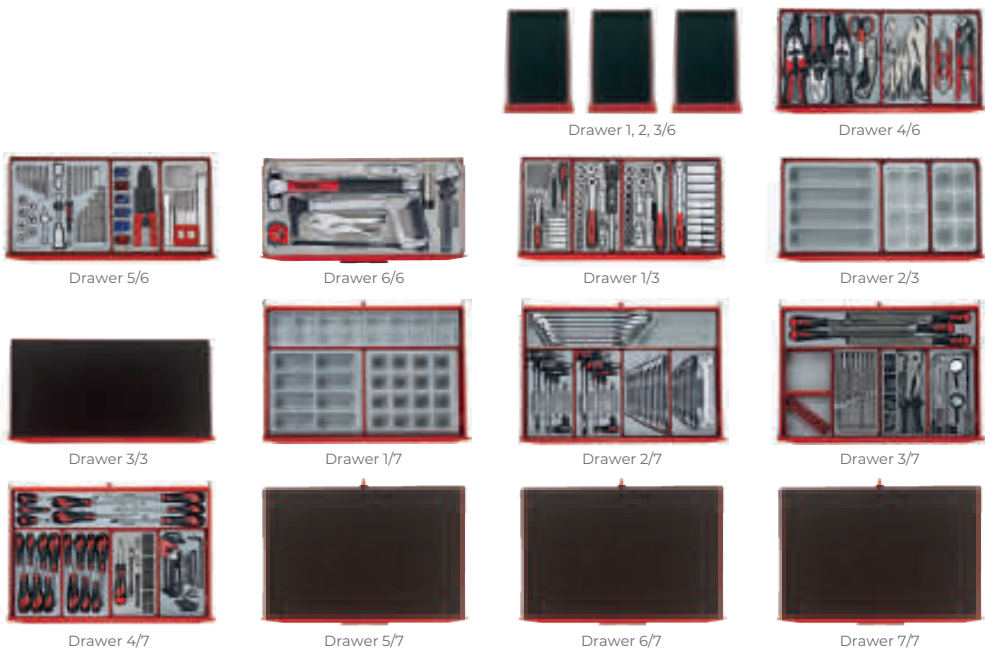

Drawer	Item ID	Description
Storage	TC806SV	Tool Box Top Box 6 Drawer SV Series
	TC803SV	Tool Box Middle Box SV 3 Drawer
	TCW707EV	Tool Box Roller Cab 7 Drawer SV Type
4/6	TTDCT05	Cutting Tool Set TT2 5 Pieces
4/6	TT440	Plier Set Vinyl Grip TTI 4 Pieces
4/6	TTVG05	Power Grip Plier Set TTI 5 Pieces
5/6	TTPC09	Punch & Chisel Set TTI 9 Pieces
5/6	TTCP121	Crimping Plier Set TTI 121 Pieces
5/6	TTDTD34	Tap and Die Set TT2 34 Pieces
6/6	TTPS09	General Tool Set BP TT4 9 Pieces
1/3	TT1435	1/4" Socket Set 6 pt TTI 35 Pieces
1/3	TT3819	3/8" Socket Set 6 pt TTI 19 Pieces
1/3	TT1218	1/2" Socket Set 12 pt TTI 118 Pieces
1/3	TT1211	1/2" Socket Set 12 pt TTI 11 Pieces
2/3	TT03	Storage Tray TTI 4 Compartments
2/3	TT04	Storage Tray TTI 6 Compartments
2/3	TTD00	Storage Tray TT2 4 Compartments
1/7	TTD01	Storage Tray TT2 8 Compartments
1/7	TTD02	Storage Tray TT2 16 Compartments
1/7	TTX03	Storage Tray TTX4 8 Compartments
2/7	TT1236	Combination Spanner Set TTI 12 Pieces
2/7	TT6208	Double Open Ended Spanner Set TTI 8 Pieces
2/7	TTHEX7	T-Handle Ball Point Hex Key Set TTI 7 Pieces
2/7	TTTX7	T-Handle TX/TPX Key Set TTI 7 Pieces
2/7	TTX2032	Combination Spanner Set TTX4 7 Pieces
3/7	TTDB28	Drill Bit Set 1.0-13.0 mm TT2 28 Pieces
3/7	TT00	Storage Tray With Tool Holder TTI
3/7	TTHR81	Rivet Gun Set TTI 81 Pieces
3/7	TTTM08	inspection Set TTI 8 Pieces
3/7	TTXF05	Hand File Set TTX4 5 Pieces
4/7	TTMD74	Ratcheting Screwdriver Bit Set TTI 74 Pieces
4/7	TT917N	Screwdriver Set Mixed TTI 7 Pieces
4/7	TT917TXN	Screwdriver Set TX & TPX TTI 7 Pieces
4/7	TTHT28	Ball Point Hex & TX Key Set TTI 28 Pieces
4/7	TTX918N	Screwdriver Set Flat & PH TTX4 8 Pieces

Item ID: **TCMM569EV**



NEW
FOAM
SERIES

MONSTER™

53" PRO ULTIMATE FOAM MONSTER 1117 PIECES

- A complete tool kit covering the requirements of most users
- All the tools are laid out in 3 colour pre-cut EVA foam trays with each tool having it's own place
- Clearly shows if any tools are not in their correct place to prevent losing tools or leaving them in the work piece
- The kit contains 33 pre-cut EVA foam trays containing over 1115 individual pieces
- Supplied in the TengTools double width TC810N 10 drawer top box and the TCW809N 9 drawer 53" wide roller cabinet

- 19 Drawer**
- 53" Wide Cabinet**
- Heavy Gauge Steel**
- 5-Step Rust Protection**
- 6" Castor Wheels with Brakes**
- 3 Step Ball Bearing Slides**
- 1117 Pieces**
- 342.8 kg**
- Comfort Grip Handle**
- Combination Lock**

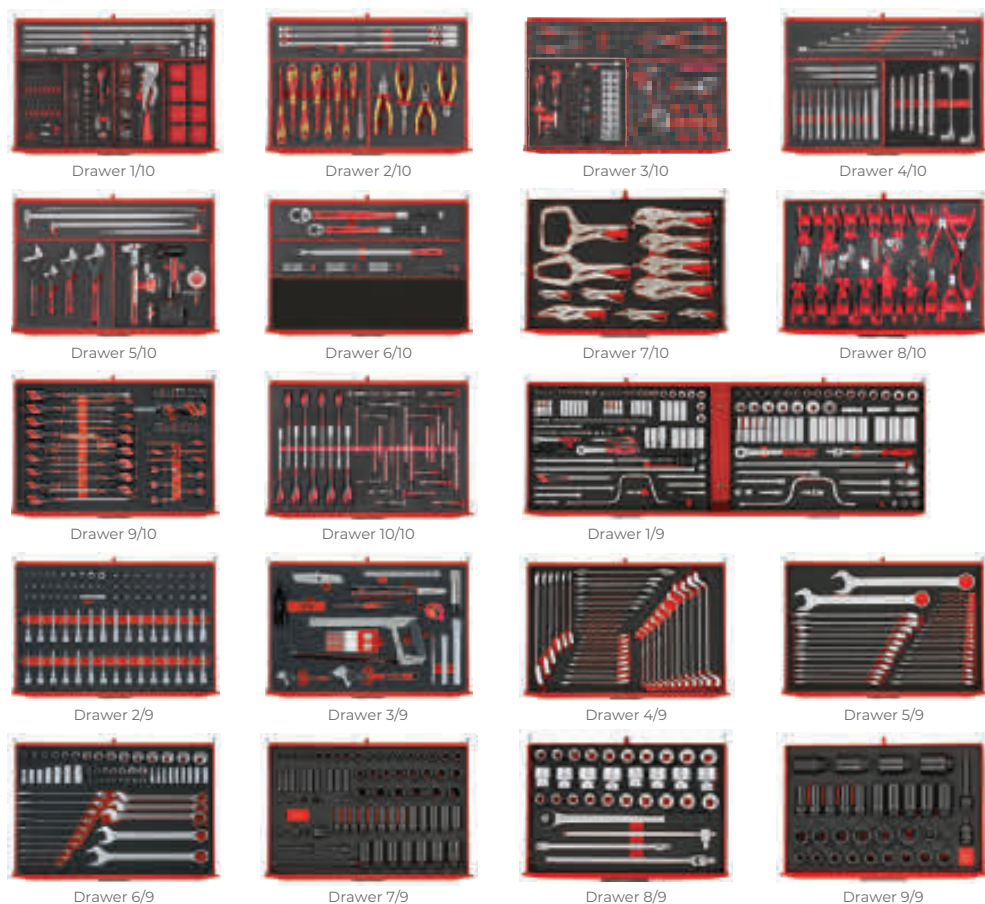

Drawer	Item ID	Description
Storage	TCW809N	Tool Box Roller Cabinet 9 Drawer 53in
	TC810N	Tool Box Top Box 10 Drawer
1/10	TEXEXT13	Extension Bars Set FOAMX4 13 Pieces
1/10	TEABS50	Impact Bit Set FOAM1 50 Pieces
1/10	TEAMDQ78	Bits Driver Set FOAM1 78 Pieces
1/10	TEAHR81	Rivet Gun Set FOAM1 81 Pieces
1/10	TEA01	Storage Tray FOAM1 7 Compartments
2/10	TEXTB05	3/8" T Bar Spark Plug Skt Set FOAMX4 5 Pieces
2/10	TEDV440	Insulated Plier Set FOAM2 4 Pieces
2/10	TEDV909N	Insulated Screwdriver Set Mixed FOAM2 9 Pieces
3/10	TEXMDTN	Power Through Screwdriver Set FOAMX4 5 Pieces
3/10	TEDSD14	Torque Screwdriver Set FOAM2 95 Pieces
3/10	TEDHT42	Ball Point Hex & TX Key Set FOAM2 42 Pieces
4/10	TEXFLS06	Long Double Ring Spanner Set FOAMX4 6 Pieces
4/10	TEDPC14	Punch & Chisel Set FOAM2 14 Pieces
4/10	TEDDF7	Double Flex Wrench Set FOAM2 7 Pieces
5/10	TEXPB4	Pry Bar Set Roll/Heel FOAMX4 4 Pieces
5/10	TEDADJ4	Adjustable Wrench Set FOAM2 4 Pieces
5/10	TEDIMM	Measuring Tool Set FOAM2 3 Pieces

Drawer	Item ID	Description
6/10	TEX1238	3/8" & 1/2" Torque Wrench Set FOAMX4 2 Pieces
6/10	TEXW05	Wheel Tool Set FOAMX4 5 Pieces
7/10	TTEVG11	Power Grip Plier Set FOAM4X4 11 Pieces
8/10	TTEMB17	Plier Set FOAM4X4 17 Pieces
9/10	TTEMD122N	Screwdriver Set Mixed FOAM4X4 122 Pieces
10/10	TTEX23N	Nut Driver T-Handle Set FOAM4X4 23 Pieces
1/9	TTESK86	1/4" & 3/8" Socket Set FOAM4X4 86 Pieces
1/9	TTESK63	1/2" Socket Set 12 pt FOAM4X4 63 Pieces
2/9	TTESK85	1/4", 3/8" & 1/2" Socket Set FOAM4X4 85 Pieces
3/9	TTEPS12	General Tool Set FOAM4X4 12 Pieces
4/9	TTESP37	Spanner Set FOAM4X4 37 Pieces
5/9	TTESP31	Combination Spanner Set FOAM4X4 31 Pieces
6/9	TTEAF62	Socket & Spanner Set AF FOAM4X4 62 Pieces
7/9	TTEISK73	3/8" & 1/2" Impact Socket Set FOAM4X4 73 Pieces
8/9	TTESK32	3/4" Socket Set FOAM4X4 32 Pieces
9/9	TTEISK33	3/4" Impact Socket Set DIN FOAM4X4 33 Pieces

Item ID: **TCEMM1117N**





NEW
FOAM
SERIES



37" PRO STACK FOAM TOOL KIT 846 PIECES

- A complete tool kit covering the requirements of most users
- All the tools are laid out in 3 coloured pre-cut foam trays with each tool having its own place
- Contrasting colour clearly show if any tools are not in their correct place to prevent losing tools or leaving them in the work place
- The kit contains 36 pre-cut foam trays containing 846 individual pieces
- Supplied in our famous extra wide TCW207N 7 drawer 37" wide roller cabinet topped with our new TC205NF 5 drawer top box
- All in TengTools red with the distinctive TengTools eyes logo on the drop front on the top box and on the bottom drawer on the cabinet

- 12 Drawer**
 - 37" Wide Cabinet**
 - Heavy Gauge Steel**
 - 5-Step Rust Protection**
 - 5" Castor Wheels with Brakes**
 - 3 Step Ball Bearing Slides**
 - Comfort Grip Handle**
 - Combination Lock**
- 846 Pieces** **230.6 kg**



Drawer	Item ID	Description
Storage	TC205NF	Tool Box 37in 5 Drawer
	TCW207N	Tool Box Roller Cabinet 37in 7 Drawer
	TCF04	Tool Box Accessory Top Box Brackets
1/5	TEZ01	Storage Tray FOAMX2 3 Compartments
1/5	TTEMB17	Plier Set FOAM4X4 17 Pieces
1/5	TEDV440	Insulated Plier Set FOAM2 4 Pieces
2/5	TEZ01	Storage Tray FOAMX2 3 Compartments
2/5	TTEAF62	Socket & Spanner Set AF FOAM4X4 62 Pieces
2/5	TEAHR81	Rivet Gun Set FOAM1 81 Pieces
2/5	TEAVSD09	1000v Torque Screwdriver Set FOAM1 9 Pieces
3/5	TEZ01	Storage Tray FOAMX2 3 Compartments
3/5	TTEX23N	Nut Driver T-Handle Set FOAM4X4 23 Pieces
3/5	TEDHT42	Ball Point Hex & TX Key Set FOAM2 42 Pieces
4/5	TEZ01	Storage Tray FOAMX2 3 Compartments
4/5	TTEMD122N	Screwdriver Set Mixed FOAM4X4 122 Pieces
4/5	TEDV909N	1000v Screwdriver Set Mixed FOAM2 9 Pieces
5/5	TEZ01	Storage Tray FOAMX2 3 Compartments
5/5	TTEPS12	General Tool Set FOAM4X4 12 Pieces
5/5	TEDIMM	Measuring Tool Set FOAM2 3 Pieces

Drawer	Item ID	Description
1/7	TEZ01	Storage Tray FOAMX2 3 Compartments
1/7	TTESK86	1/4" & 3/8" Socket Set FOAM4X4 86 Pieces
1/7	TED01	Storage Tray FOAM2 8 Compartments
2/7	TEZ01	Storage Tray FOAMX2 3 Compartments
2/7	TTESK63	1/2" Socket Set 12 pt FOAM4X4 63 Pieces
2/7	TEDDF7	Double Flex Wrench Set FOAM2 7 Pieces
3/7	TEZ01	Storage Tray FOAMX2 3 Compartments
3/7	TTESK85	1/4", 3/8" & 1/2" Socket Set FOAM4X4 85 Pieces
3/7	TEDSD14	Torque Screwdriver Set FOAM2 95 Pieces
4/7	TEZ01	Storage Tray FOAMX2 3 Compartments
4/7	TTESP31	Combination Spanner Set FOAM4X4 31 Pieces
4/7	TED6512R	Ratcheting Spanner Set R FOAM2 12 Pieces
5/7	TEZ01	Storage Tray FOAMX2 3 Compartments
5/7	TEX1238	3/8" & 1/2" Torque Wrench Set FOAMX4 2 Pieces
5/7	TEXPB4	Pry Bar Set Roll/Heel FOAMX4 4 Pieces
5/7	TEX6308	Double Ring Spanner Set FOAMX4 8 Pieces
5/7	TED01	Storage Tray FOAM2 8 Compartments
7/7	TEZ01	Storage Tray FOAMX2 3 Compartments
7/7	TTESK32	3/4" Socket Set FOAM4X4 32 Pieces
7/7	TED9121	1/2" Impact Socket Set ANSI FOAM2 21 Pieces

Item ID: **TCMME846N**

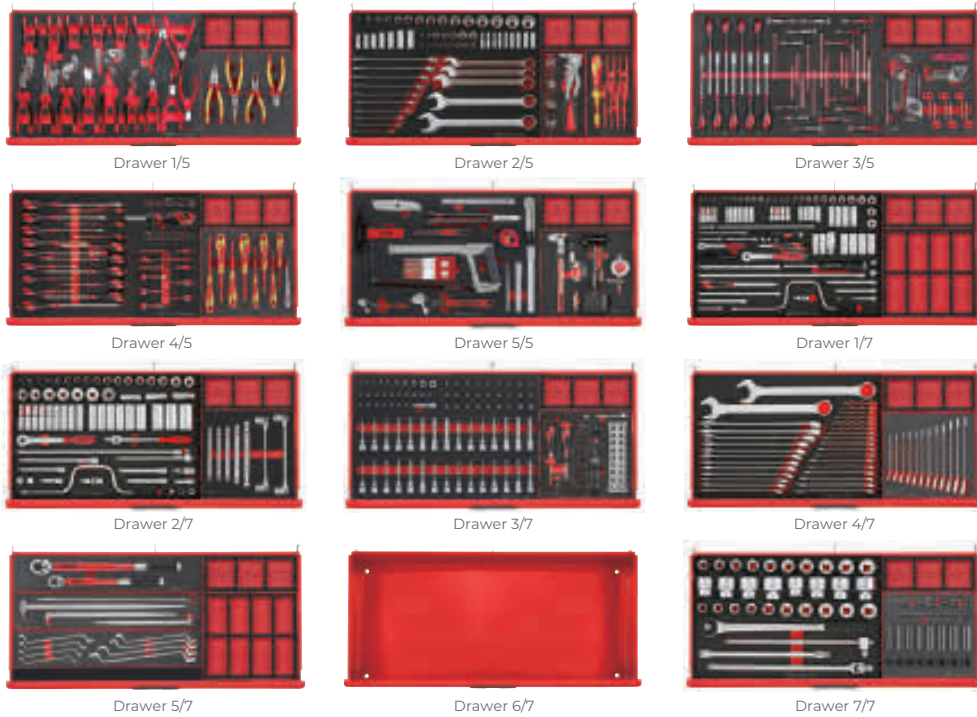

FOAM SERIES



26" PRO STACK FOAM TOOL KIT 530 PIECES

- A complete tool kit covering the requirements of most users
- All the tools are laid out in 3 colour pre-cut EVA foam trays with each tool having it's own place
- Clearly shows if any tools are not in their correct place to prevent losing tools or leaving them in the work piece
- Supplied in the TengTools TC805NFX full depth 5 drawer top box and TCW806N1 6 drawer roller cabinet

- 11** Drawer
- 26"** Wide Cabinet
- Heavy Gauge Steel**
- 5-Step Rust Protection**
- 5"** Castor Wheels with Brakes
- 3 Step Ball Bearing Slides**
- Comfort Grip Handle**
- Combination Lock**

530 Pieces 201.5 kg

Drawer	Item ID	Description
Storage	TC805NFX	Tool Box Top Box 5 Drawer
	TCW806N1	Tool Box Roller Cabinet 6 Drawers
1/5	TTESK86	1/4" & 3/8" Socket Set FOAM4X4 86 Pieces
2/5	TTEISK73	3/8" & 1/2" Impact Socket Set FOAM4X4 73 Pieces
3/5	TTESK63	1/2" Socket Set 12 pt FOAM4X4 63 Pieces
4/5	TTEISK33	3/4" Impact Socket Set DIN FOAM4X4 33 Pieces
5/5	TTESK32	3/4" Socket Set FOAM4X4 32 Pieces
1/6	TTEX23N	Nut Driver T-Handle Set FOAM4X4 23 Pieces
2/6	TTESP31	Combination Spanner Set FOAM4X4 31 Pieces
3/6	TTEVG11	Power Grip Plier Set FOAM4X4 11 Pieces
4/6	TTEMD122N	Screwdriver Set Mixed FOAM4X4 122 Pieces
5/6	TTESP37	Spanner Set FOAM4X4 37 Pieces
6/6	TTEMB17	Plier Set FOAM4X4 17 Pieces

Item ID: TCMME09A

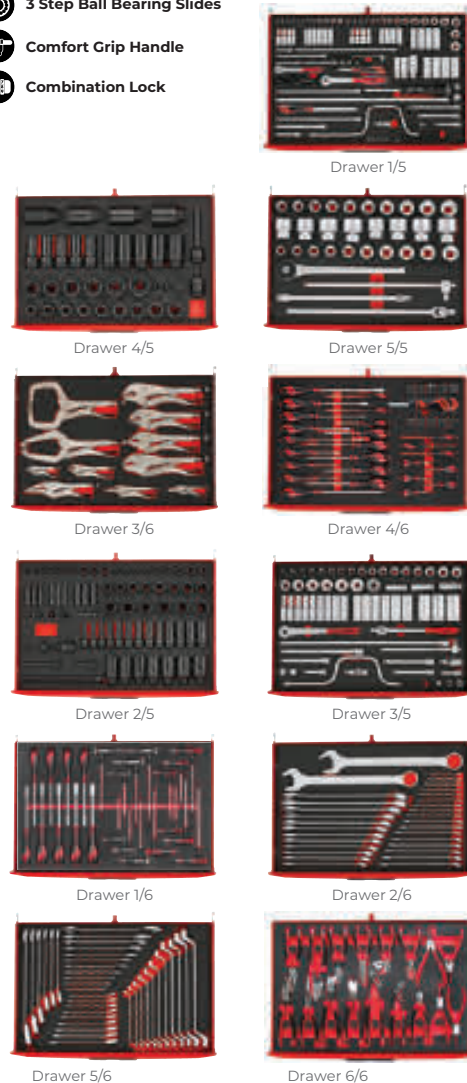

26" PRO STACK FOAM TOOL KIT 417 PIECES

- A complete tool kit covering the requirements of most users
- All the tools are laid out in 3 colour pre-cut EVA foam trays with each tool having it's own place
- Clearly shows if any tools are not in their correct place to prevent losing tools or leaving them in the work piece
- Supplied in the TengTools TC806NF 6 drawer top box and TCW807N 7 drawer roller cabinet
- A comprehensive selection of tools using 7 of the available 13 drawers ensuring that space is still available to add to the kit if needed

- 13** Drawer
- 26"** Wide Cabinet
- Heavy Gauge Steel**
- 5-Step Rust Protection**
- 5"** Castor Wheels with Brakes
- 3 Step Ball Bearing Slides**
- Comfort Grip Handle**
- Combination Lock**

417 Pieces 138.3 kg

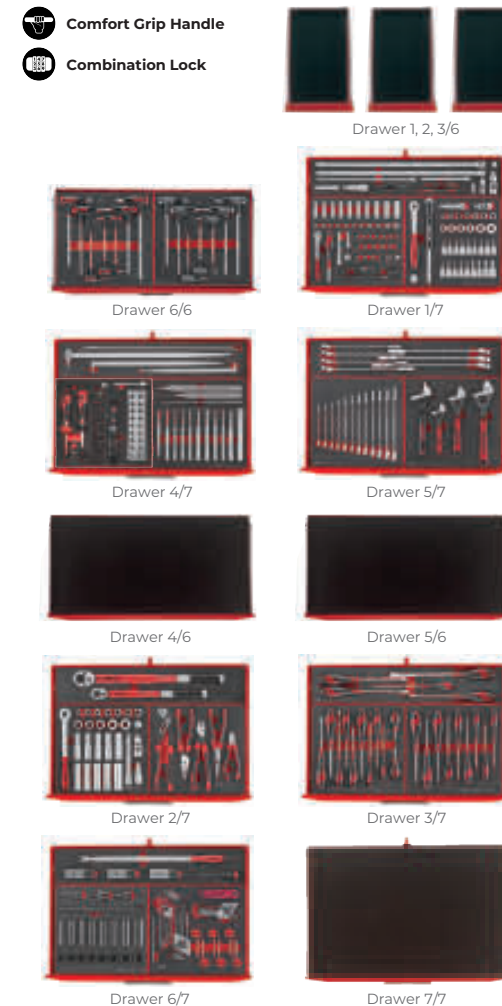

Drawer	Item ID	Description
Storage	TC806NF	Tool Box Top Box 6 Drawer
	TCW807N	Tool Box Roller Cabinet 7 Drawer
6/6	TEDHEX7	T-Handle Ball Point Hex Key Set FOAM2 7 Pieces
6/6	TEDTX7	T-Handle Ball Point TX Key Set FOAM2 7 Pieces
1/7	TEXEXT13	Extension Bars Set FOAMX4 13 Pieces
1/7	TED1489	1/4" Socket Set 6 pt FOAM2 89 Pieces
1/7	TED3836	3/8" Socket Set 6 pt FOAM2 36 Pieces
2/7	TEX1238	3/8" & 1/2" Torque Wrench Set FOAMX4 2 Pieces
2/7	TED1227	1/2" Socket Set 12 pt FOAM2 27 Pieces
2/7	TED441-T	Plier Set TPR Grip FOAM2 5 Pieces
3/7	TEX915N	Screwdriver Set Flat & PH FOAMX4 5 Pieces
3/7	TED911N	Screwdriver Set Mixed FOAM2 11 Pieces
3/7	TED909TXN	Screwdriver Set TX FOAM2 9 Pieces
4/7	TEXPB4	Pry Bar Set Roll/Heel FOAMX4 4 Pieces
4/7	TEDSD14	Torque Screwdriver Set FOAM2 95 Pieces
4/7	TEDPC14	Punch & Chisel Set FOAM2 14 Pieces
5/7	TEX2032	Combination Spanner Set FOAMX4 7 Pieces
5/7	TED8012	Spanner Set Anti Slip FOAM2 12 Pieces
5/7	TEDADJ4	Adjustable Wrench Set FOAM2 4 Pieces
6/7	TEXW05	Wheel Tool Set FOAMX4 5 Pieces
6/7	TED9121	1/2" Impact Socket Set ANSI FOAM2 21 Pieces
6/7	TEDHT42	Ball Point Hex & TX Key Set FOAM2 42 Pieces

Item ID: TCEMM417N



FOAM SERIES



26" PRO STACK FOAM TOOL KIT 249 PIECES

- A complete tool kit covering the requirements of most users
- All the tools are laid out in 3 colour pre-cut EVA foam trays with each tool having its own place
- Clearly shows if any tools are not in their correct place to prevent losing tools or leaving them in the work piece
- Supplied in the TengTools TC806NF 6 drawer top box and TCW807N 7 drawer roller cabinet
- A comprehensive selection of tools using 6 of the available 13 drawers ensuring that space is still available to add to the kit if needed

- 13 Drawer
- 26" Wide Cabinet
- Heavy Gauge Steel
- 5-Step Rust Protection
- 5" Castor Wheels with Brakes
- 3 Step Ball Bearing Slides
- Comfort Grip Handle
- Combination Lock

249 Pieces 114 kg

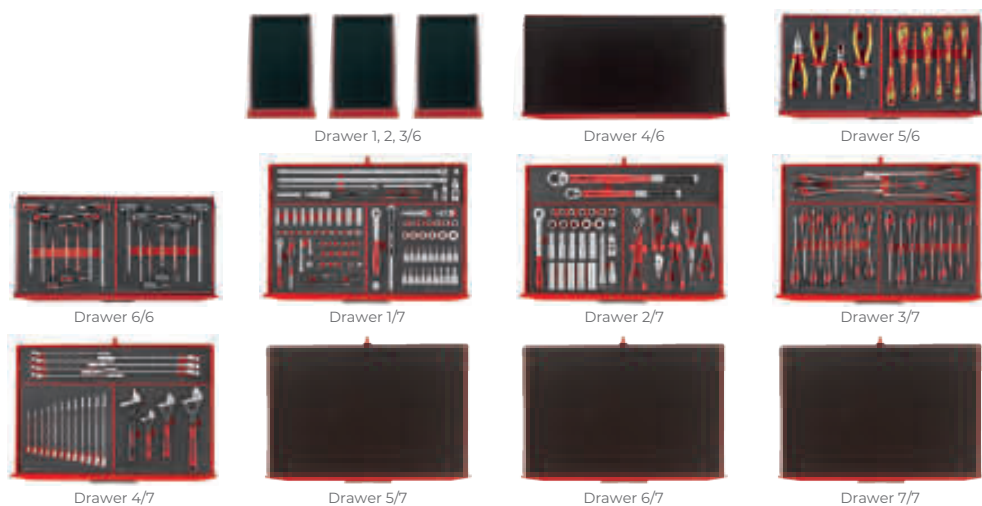

Drawer	Item ID	Description
Storage	TC806NF	Tool Box Top Box 6 Drawer
	TCW807N	Tool Box Roller Cabinet 7 Drawer
5/6	TEDV440	Insulated Plier Set FOAM2 4 Pieces
5/6	TEDV909N	Insulated Screwdriver Set Mixed FOAM2 9 Pieces
6/6	TEDHEX7	T-Handle Ball Point Hex Key Set FOAM2 7 Pieces
6/6	TEDTX7	T-Handle Ball Point TX Key Set FOAM2 7 Pieces
1/7	TEXEXT13	Extension Bars Set FOAMX4 13 Pieces
1/7	TED1489	1/4" Socket Set 6 pt FOAM2 89 Pieces
1/7	TED3836	3/8" Socket Set 6 pt FOAM2 36 Pieces

Drawer	Item ID	Description
2/7	TEX1238	3/8" & 1/2" Torque Wrench Set FOAMX4 2 Pieces
2/7	TED1227	1/2" Socket Set 12 pt FOAM2 27 Pieces
2/7	TED441-T	Plier Set TPR Grip FOAM2 5 Pieces
3/7	TEX915N	Screwdriver Set Flat & PH FOAMX4 5 Pieces
3/7	TED911N	Screwdriver Set Mixed FOAM2 11 Pieces
3/7	TED909TXN	Screwdriver Set TX FOAM2 9 Pieces
4/7	TEX2032	Combination Spanner Set FOAMX4 7 Pieces
4/7	TED8012	Spanner Set Anti Slip FOAM2 12 Pieces
4/7	TEDADJ4	Adjustable Wrench Set FOAM2 4 Pieces

Item ID: TCEMM249N



TT
SERIES



37" PRO CABINET TT TOOL KIT 622 PIECES

- A complete tool kit covering the requirements of most users
- All the tools are laid out in individual tool trays using the TengTools Get Organised system
- Easy to see if any tools have been mislaid or lost helping to prevent leaving them with the work piece
- Supplied in the TengTools extra wide TCW207N 7 drawer 37" (950mm) wide roller cabinet
- A comprehensive selection of tools using 6 of the available 7 drawers ensuring that space is still available to add to the kit if needed

- 7 Drawer**
- 37" Wide Cabinet**
- Heavy Gauge Steel**
- 5-Step Rust Protection**
- 5" Castor Wheels with Brakes**
- 3 Step Ball Bearing Slides**
- Comfort Grip Handle**
- Combination Lock**

622
Pieces 138 kg



Drawer 1/7



Drawer 2/7

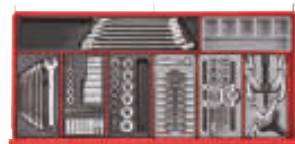

Drawer 3/7



Drawer 4/7



Drawer 5/7



Drawer 6/7



Drawer 7/7

Drawer	Item ID	Description
Storage	TCW207N	Tool Box Roller Cabinet 37in 7 Drawer
	TC-TB03	Work Top
1/7	TTXEXT13	Extension Bars Set TTX4 13 Pieces
1/7	TT1435	1/4" Socket Set 6 pt TT1 35 Pieces
1/7	TT3819	3/8" Socket Set 6 pt TT1 19 Pieces
1/7	TT1217	1/2" Socket Set 12 pt TT1 17 Pieces
1/7	TT1205	1/2" Ratchet & Accessories Set TT1 5 Pieces
1/7	TTHEX7	T-Handle Ball Point Hex Key Set TT1 7 Pieces
1/7	TTTX7	T-Handle TX/TPX Key Set TT1 7 Pieces
1/7	TTZ01	Storage Tray TTX2 6 Compartments
2/7	TTX2032	Combination Spanner Set TTX4 7 Pieces
2/7	TT1236	Combination Spanner Set TT1 12 Pieces
2/7	TTSN11	Extractor & Nut Splitter Set TT1 11 Pieces
2/7	TTOS16	Oil Service Set TT1 16 Pieces
2/7	TTM116	Mini Pliers & Screwdriver Set TT1 16 Pieces
2/7	TT474-7	Circlip Plier Set 19-60 mm TT1 4 Pieces
2/7	TT440	Plier Set Vinyl Grip TT1 4 Pieces
2/7	TTZVG03	Power Grip Plier Set TTX2 3 Pieces
3/7	TTX2640	Combination Spanner Set AF TTX4 7 Pieces
3/7	TT3592	Combination Spanner Set AF TT1 8 Pieces
3/7	TTAF32	1/4" & 3/8" Socket Set AF 6 pt TT1 32 Pieces
3/7	TT1215AF	1/2" Socket Set 12 pt AF TT1 15 Pieces
3/7	TTTX30	3/8" TX Bit Socket Set TT1 30 Pieces
3/7	TTTD17	Tap and Die Set TT1 17 Pieces

Drawer	Item ID	Description
3/7	TT804	Puller Set TT1 4 Pieces
3/7	TTZ01	Storage Tray TTX2 6 Compartments
4/7	TTX918N	Screwdriver Set Flat & PH TTX4 8 Pieces
4/7	TTPS09	General Tool Set BP TT4 9 Pieces
4/7	TT917N	Screwdriver Set Mixed TT1 7 Pieces
4/7	TT917TXN	Screwdriver Set TX & TPX TT1 7 Pieces
4/7	TTZ01	Storage Tray TTX2 6 Compartments
5/7	TTX1292	1/2" Torque Wrench 40-210 Nm TTX4
5/7	TT9116N	1/2" Impact Socket Set ANSI TT1 16 Pieces
5/7	TTHEX23	1/2" Hex Bit Socket Set TT1 23 Pieces
5/7	TTALU	Clip Rail Set TT1 32 Pieces
5/7	TTTX23	1/2" TX Bit Socket Set TT1 23 Pieces
5/7	TTID20	1/2" Impact Driver Set TT1 20 Pieces
5/7	TTMD74	Ratcheting Screwdriver Bit Set TT1 74 Pieces
5/7	TTZ01	Storage Tray TTX2 6 Compartments
6/7	TTX6311	Double Ring Spanner Set TTX4 11 Pieces
6/7	TTXPB3	Pry Bar Set Roll/Heel TTX4 3 Pieces
6/7	TTXMB02	Plier & Wrench Set TTX4 2 Pieces
6/7	TTNR81	Nutsert Gun Set TT1 81 Pieces
6/7	TTPC09	Punch & Chisel Set TT1 9 Pieces
6/7	TTZ01	Storage Tray TTX2 6 Compartments

Item ID: **TCMM622N**

TT
SERIES



53" PRO CABINET TT TOOL KIT 569 PIECES

- A complete tool kit covering the requirements of most users
- All the tools are laid out in individual tool trays using the TengTools Get Organised system
- Easy to see if any tools have been mislaid or lost helping to prevent leaving them with the work piece
- Supplied in the TengTools double width TCW809N 9 drawer 53" wide roller cabinet
- A comprehensive selection of tools using 8 of the available 9 drawers ensuring that space is still available to add to the kit if needed

- 9 Drawer**
- 53" Wide Cabinet**
- Heavy Gauge Steel**
- 5-Step Rust Protection**
- 5" Castor Wheels with Brakes**
- 3 Step Ball Bearing Slides**
- Comfort Grip Handle**
- Combination Lock**

569
Pieces 138 kg



Drawer 1/9



Drawer 2/9



Drawer 3/9



Drawer 4/9



Drawer 5/9



Drawer 6/9



Drawer 7/9



Drawer 8/9



Drawer 9/9

Drawer	Item ID	Description
Storage	TCW809N	Tool Box Roller Cabinet 9 Drawer 53in
2/9	TTXEXT13	Extension Bars Set TTX4 13 Pieces
2/9	TT1435	1/4" Socket Set 6 pt TT1 35 Pieces
2/9	TT3819	3/8" Socket Set 6 pt TT1 19 Pieces
2/9	TT1205	1/2" Ratchet & Accessories Set TT1 5 Pieces
2/9	TT1217	1/2" Socket Set 12 pt TT1 17 Pieces
3/9	TTX474-9	Circlip Plier Set 40-100 mm TTX4 4 Pieces
3/9	TT440-T	Plier Set TPR Grip TT1 4 Pieces
3/9	TTVG05	Power Grip Plier Set TT1 5 Pieces
3/9	TTDCT05	Cutting Tool Set TT2 5 Pieces
4/9	TTXF05	Hand File Set TTX4 5 Pieces
4/9	TTTX30	3/8" TX Bit Socket Set TT1 30 Pieces
4/9	TTBS35	1/4" & 3/8" Bit Socket Set TT1 35 Pieces
4/9	TTTXH15	1/2" Hex & TX Bit Socket Set TT1 15 Pieces
4/9	TTRS15	1/2" Ribe & XZN Bit Socket Set TT1 15 Pieces
5/9	TTX2640	Combination Spanner Set AF TTX4 7 Pieces
5/9	TTAF32	1/4" & 3/8" Socket Set AF 6 pt TT1 32 Pieces
5/9	TT1215AF	1/2" Socket Set 12 pt AF TT1 15 Pieces
5/9	TT3592	Combination Spanner Set AF TT1 8 Pieces
5/9	TT3816	3/8" Socket Set 6 pt TT1 16 Pieces

Drawer	Item ID	Description
6/9	TTX918N	Screwdriver Set Flat & PH TTX4 8 Pieces
6/9	TT917N	Screwdriver Set Mixed TT1 7 Pieces
6/9	TT917TXN	Screwdriver Set TX & TPX TT1 7 Pieces
6/9	TTMD74	Ratcheting Screwdriver Bit Set TT1 74 Pieces
6/9	TTDB28	Drill Bit Set 1.0-13.0 mm TT2 28 Pieces
7/9	TTX2032	Combination Spanner Set TTX4 7 Pieces
7/9	TT1236	Combination Spanner Set TT1 12 Pieces
7/9	TT6508R	Ratcheting Spanner Set R TT1 8 Pieces
7/9	TT6208	Double Open Ended Spanner Set TT1 8 Pieces
7/9	TT474-7	Circlip Plier Set 19-60 mm TT1 4 Pieces
8/9	TTX3404	3/4" Ratchet & Accessories Set TTX4 4 Pieces
8/9	TTHT28	Ball Point Hex & TX Key Set TT1 28 Pieces
8/9	TTHEX7	T-Handle Ball Point Hex Key Set TT1 7 Pieces
8/9	TTTX7	T-Handle TX/TPX Key Set TT1 7 Pieces
8/9	TTM08	inspection Set TT1 8 Pieces
9/9	TTX3414	3/4" Socket Set 6 pt TTX4 14 Pieces
9/9	TT9207	1/2" Impact Accessories Set DIN TT1 11 Pieces
9/9	TT9120DN	1/2" Impact Socket Set DIN TT1 20 Pieces
9/9	TTID20	1/2" Impact Driver Set TT1 20 Pieces
9/9	TTBM	Measuring Tool Set TT1 4 Pieces

Item ID: TCMIND08

TT
SERIES



26" PRO CABINET TT TOOL KIT 546 PIECES

- A complete tool kit covering the requirements of most users
- All the tools are laid out in individual tool trays using the TengTools Get Organised system
- Easy to see if any tools have been mislaid or lost helping to prevent leaving them with the work piece
- Supplied in a red TengTools TCW808N 8 drawer roller cabinet
- A comprehensive selection of tools using 7 of the available 8 drawers ensuring that space is still available to add to the kit if needed

- 8 Drawer**
- 26" Wide Cabinet**
- Heavy Gauge Steel**
- 5-Step Rust Protection**
- 5" Castor Wheels with Brakes**
- 3 Step Ball Bearing Slides**
- Comfort Grip Handle**
- Combination Lock**

546
Pieces 84.7 kg



Drawer	Item ID	Description
Storage	TCW808N	Tool Box Roller Cabinet 8 Drawer
1/8	TT1205	1/2" Ratchet & Accessories Set TTI 5 Pieces
1/8	TT1217	1/2" Socket Set 12 pt TTI 17 Pieces
1/8	TT1435	1/4" Socket Set 6 pt TTI 35 Pieces
1/8	TT3819	3/8" Socket Set 6 pt TTI 19 Pieces
1/8	TTXEXT13	Extension Bars Set TTX4 13 Pieces
2/8	TT01	Storage Tray TTI 7 Compartments
2/8	TT917N	Screwdriver Set Mixed TTI 7 Pieces
2/8	TT917TXN	Screwdriver Set TX & TPX TTI 7 Pieces
2/8	TTMD74	Ratcheting Screwdriver Bit Set TTI 74 Pieces
2/8	TTXMDTN	Power Through Screwdriver Set TTX4 5 Pieces
3/8	TT01	Storage Tray TTI 7 Compartments
3/8	TTCP121	Crimping Plier Set TTI 121 Pieces
3/8	TTHEX7	T-Handle Ball Point Hex Key Set TTI 7 Pieces
3/8	TTHR81	Rivet Gun Set TTI 81 Pieces
3/8	TTX00	Storage Tray TTX4 1 Compartment
4/8	TTHT28	Ball Point Hex & TX Key Set TTI 28 Pieces

Drawer	Item ID	Description
4/8	TTMD12D	Screwdriver Blade Set Mixed TTI 12 Pieces
4/8	TTNF12	Needle File Set TTI 12 Pieces
4/8	TTSR04	Scraper Set TTI 4 Pieces
4/8	TTXF05	Hand File Set TTX4 5 Pieces
5/8	TT1236	Combination Spanner Set TTI 12 Pieces
5/8	TT440-T	Plier Set TPR Grip TTI 4 Pieces
5/8	TT474-7	Circlip Plier Set 19-60 mm TTI 4 Pieces
5/8	TT6208	Double Open Ended Spanner Set TTI 8 Pieces
5/8	TTX2032	Combination Spanner Set TTX4 7 Pieces
6/8	TT804	Puller Set TTI 4 Pieces
6/8	TTALU	Clip Rail Set TTI 32 Pieces
6/8	TTPC09	Punch & Chisel Set TTI 9 Pieces
6/8	TTXH15	1/2" Hex & TX Bit Socket Set TTI 15 Pieces
6/8	TTXND	Nut Driver Set TTX4 9 Pieces
7/8	TTPS09	General Tool Set BP TT4 9 Pieces
7/8	TTX01	Storage Tray TTX4 6 Compartments

Item ID: **TCMM546N**





TT SERIES



- 7 Drawer**
- 26" Wide Cabinet**
- Heavy Gauge Steel**
- 5-Step Rust Protection**
- 5" Castor Wheels with Brakes**
- 3 Step Ball Bearing Slides**
- Comfort Grip Handle**
- Combination Lock**

491 Pieces 83.4 kg

26" PRO CABINET TT TOOL KIT 491 PIECES

- A complete tool kit covering the requirements of most users
- All the tools are laid out in individual tool trays using the TengTools Get Organised system
- Easy to see if any tools have been mislaid or lost helping to prevent leaving them with the work piece
- Supplied in a red TengTools TCW807N 7 drawer roller cabinet
- A comprehensive selection of tools using 6 of the available 7 drawers ensuring that space is still available to add to the kit if needed

Drawer	Item ID	Description
Storage	TCW807N	Tool Box Roller Cabinet 7 Drawer
1/7	TTXND	Nut Driver Set TTX4 9 Pieces
1/7	TT1435	1/4" Socket Set 6 pt TT1 35 Pieces
1/7	TT3819	3/8" Socket Set 6 pt TT1 19 Pieces
1/7	TT1236	Combination Spanner Set TT1 12 Pieces
1/7	TT6208	Double Open Ended Spanner Set TT1 8 Pieces
2/7	TTXMDTN	Power Through Screwdriver Set TTX4 5 Pieces
2/7	TTMD74	Ratcheting Screwdriver Bit Set TT1 74 Pieces
2/7	TTHX7	T-Handle Ball Point Hex Key Set TT1 7 Pieces
2/7	TT917N	Screwdriver Set Mixed TT1 7 Pieces
2/7	TT917TXN	Screwdriver Set TX & TPX TT1 7 Pieces
3/7	TTX00	Storage Tray TTX4 1 Compartment
3/7	TT440-T	Plier Set TPR Grip TT1 4 Pieces
3/7	TTPC09	Punch & Chisel Set TT1 9 Pieces
3/7	TTCP121	Crimping Plier Set TT1 121 Pieces
3/7	TTTX7	T-Handle TX/TPX Key Set TT1 7 Pieces
4/7	TTX01	Storage Tray TTX4 6 Compartments
4/7	TTPS09	General Tool Set BP TT4 9 Pieces
5/7	TTXEXT13	Extension Bars Set TTX4 13 Pieces
5/7	TT1217	1/2" Socket Set 12 pt TT1 17 Pieces
5/7	TT1205	1/2" Ratchet & Accessories Set TT1 5 Pieces
5/7	TTTXH15	1/2" Hex & TX Bit Socket Set TT1 15 Pieces
5/7	TTALU	Clip Rail Set TT1 32 Pieces
6/7	TTX2032	Combination Spanner Set TTX4 7 Pieces
6/7	TTHR81	Rivet Gun Set TT1 81 Pieces
6/7	TT804	Puller Set TT1 4 Pieces
6/7	TT474-7	Circlip Plier Set 19-60 mm TT1 4 Pieces
6/7	TT01	Storage Tray TT1 7 Compartments

Item ID: **TCMM491N**



Drawer 1/7



Drawer 2/7



Drawer 3/7



Drawer 4/7



Drawer 5/7

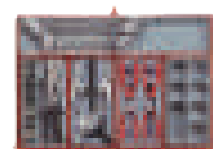

Drawer 6/7



Drawer 7/7



TT SERIES



- 7 Drawer**
- 26" Wide Cabinet**
- Heavy Gauge Steel**
- 5-Step Rust Protection**
- 5" Castor Wheels with Brakes**
- 3 Step Ball Bearing Slides**
- Key Lock Lock**

277 Pieces 74.3 kg

26" STD CABINET TT TOOL KIT 277 PIECES

- A complete tool kit covering the requirements of most users
- All the tools are laid out in individual tool trays using the TengTools Get Organised system
- Easy to see if any tools have been mislaid or lost helping to prevent leaving them with the work piece
- Supplied in a red TengTools TCW707EV 7 drawer roller cabinet
- A comprehensive selection of tools using 4 of the available 7 drawers ensuring that space is still available to add to the kit if needed

Drawer	Item ID	Description
Storage	TCW707EV	Tool Box Roller Cab 7 Drawer SV Type
1/7	TT1435	1/4" Socket Set 6 pt TT1 35 Pieces
1/7	TT3819	3/8" Socket Set 6 pt TT1 19 Pieces
1/7	TT1211	1/2" Socket Set 12 pt TT1 11 Pieces
1/7	TT1218	1/2" Socket Set 12 pt TT1 118 Pieces
1/7	TTXEXT13	Extension Bars Set TTX4 13 Pieces
2/7	TT1236	Combination Spanner Set TT1 12 Pieces
2/7	TT6208	Double Open Ended Spanner Set TT1 8 Pieces
2/7	TTHX7	T-Handle Ball Point Hex Key Set TT1 7 Pieces
2/7	TTTX7	T-Handle TX/TPX Key Set TT1 7 Pieces
2/7	TTX2032	Combination Spanner Set TTX4 7 Pieces
3/7	TT440	Plier Set Vinyl Grip TT1 4 Pieces
3/7	TTVG05	Power Grip Plier Set TT1 5 Pieces
3/7	TTDCT05	Cutting Tool Set TT2 5 Pieces
3/7	TTX1292	1/2" Torque Wrench 40-210 Nm TTX4
4/7	TTMD74	Ratcheting Screwdriver Bit Set TT1 74 Pieces
4/7	TT917N	Screwdriver Set Mixed TT1 7 Pieces
4/7	TT917TXN	Screwdriver Set TX & TPX TT1 7 Pieces
4/7	TTH28	Ball Point Hex & TX Key Set TT1 28 Pieces
4/7	TTX918N	Screwdriver Set Flat & PH TTX4 8 Pieces
6/7	TT01	Storage Tray TT1 7 Compartments

Item ID: **TCMM277EV**



Drawer 1/7



Drawer 2/7



Drawer 3/7



Drawer 4/7



Drawer 5/7



Drawer 6/7



Drawer 7/7



FOAM SERIES



37" PRO CABINET FOAM TOOL KIT 631 PIECES

- A complete tool kit covering the requirements of most users
- All the tools are laid out in 3 colour pre-cut EVA foam trays with each tool having it's own place
- Clearly shows if any tools are not in their correct place to prevent losing tools or leaving them in the work piece
- Supplied in the TengTools extra wide TCW207N 7 drawer 37" (950mm) wide roller cabinet
- A comprehensive selection of tools using 6 of the available 7 drawers ensuring that space is still available to add to the kit if needed

- 7 Drawer**
- 37" Wide Cabinet**
- Heavy Gauge Steel**
- 5-Step Rust Protection**
- 5" Castor Wheels with Brakes**
- 3 Step Ball Bearing Slides**
- Comfort Grip Handle**
- Combination Lock**

631 Pieces 138 kg



Drawer 1/7



Drawer 2/7



Drawer 3/7



Drawer 4/7



Drawer 5/7



Drawer 6/7



Drawer 7/7



Drawer	Item ID	Description
Storage	TCW207N	Tool Box Roller Cabinet 37in 7 Drawer
	TC-TB03	Work Top
1/7	TTESK77	1/4", 3/8" & 1/2" Socket Set FOAM4X4 77 Pieces
1/7	TEDHT42	Ball Point Hex & TX Key Set FOAM2 42 Pieces
1/7	TEZ01	Storage Tray FOAMX2 3 Compartments
2/7	TTEX32	Spanner & File Set FOAM4X4 32 Pieces
2/7	TEDDF7	Double Flex Wrench Set FOAM2 7 Pieces
2/7	TEZ01	Storage Tray FOAMX2 3 Compartments
3/7	TTEMMD122N	Screwdriver Set Mixed FOAM4X4 122 Pieces
3/7	TEDV909N	Insulated Screwdriver Set Mixed FOAM2 9 Pieces
3/7	TEZ01	Storage Tray FOAMX2 3 Compartments
4/7	TTEMB11	Plier Set FOAM4X4 11 Pieces
4/7	TEDV440	Insulated Plier Set FOAM2 4 Pieces
4/7	TEZ01	Storage Tray FOAMX2 3 Compartments
5/7	TTESK85	1/4", 3/8" & 1/2" Socket Set FOAM4X4 85 Pieces
5/7	TEDSD95	Torque Screwdriver Set FOAM2 95 Pieces OLD
5/7	TEZ01	Storage Tray FOAMX2 3 Compartments
6/7	TTEPS12	General Tool Set FOAM4X4 12 Pieces
6/7	TEAHR81	Rivet Gun Set FOAM1 81 Pieces
6/7	TEABSS0	Impact Bit Set FOAM1 50 Pieces
6/7	TEZ01	Storage Tray FOAMX2 3 Compartments

Item ID: TCEMM631N



FOAM SERIES



- 7 Drawer**
- 26" Wide Cabinet**
- Heavy Gauge Steel**
- 5-Step Rust Protection**
- 5" Castor Wheels with Brakes**
- 3 Step Ball Bearing Slides**
- Comfort Grip Handle**
- Combination Lock**

333 Pieces 91.5 kg

26" PRO CABINET FOAM TOOL KIT 333 PIECES

- A complete tool kit covering the requirements of most users
- All the tools are laid out in 3 colour pre-cut EVA foam trays with each tool having it's own place
- Clearly shows if any tools are not in their correct place to prevent losing tools or leaving them in the work piece
- Supplied in the TengTools TCW807N 7 drawer roller cabinet

Drawer	Item ID	Description
Storage	TCW807N	Tool Box Roller Cabinet 7 Drawer
1/7	TTEMB11	Plier Set FOAM4X4 11 Pieces
2/7	TTEMD98N	Screwdriver Set Mixed FOAM4X4 98 Pieces
3/7	TTEP512	General Tool Set FOAM4X4 12 Pieces
4/7	TTESK85	1/4", 3/8" & 1/2" Socket Set FOAM4X4 85 Pieces
5/7	TTESK77	1/4", 3/8" & 1/2" Socket Set FOAM4X4 77 Pieces
6/7	TTEX17	General Tool Set FOAM4X4 17 Pieces
7/7	TTEX32	Spanner & File Set FOAM4X4 32 Pieces

Item ID: **TCMME11A**

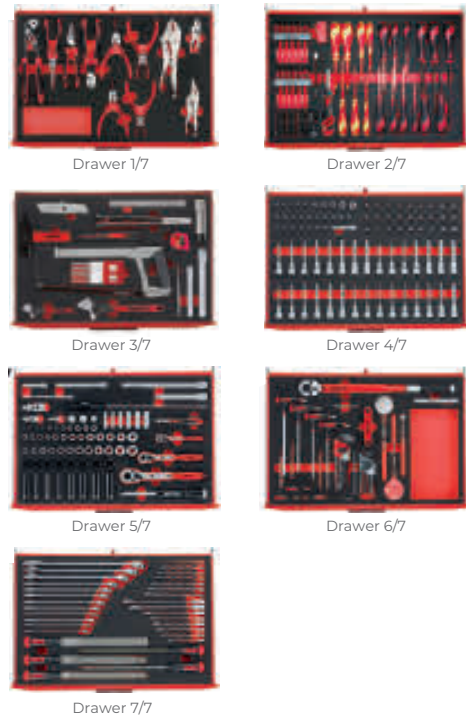

Drawer 1/7 Drawer 2/7
 Drawer 3/7 Drawer 4/7
 Drawer 5/7 Drawer 6/7
 Drawer 7/7

FOAM SERIES



- 7 Drawer**
- 26" Wide Cabinet**
- Heavy Gauge Steel**
- 5-Step Rust Protection**
- 5" Castor Wheels with Brakes**
- 3 Step Ball Bearing Slides**
- Comfort Grip Handle**
- Combination Lock**

280 Pieces 87.7 kg

26" PRO CABINET FOAM TOOL KIT 280 PIECES

- A complete tool kit covering the requirements of most users
- All the tools are laid out in 3 colour pre-cut EVA foam trays with each tool having it's own place
- Clearly shows if any tools are not in their correct place to prevent losing tools or leaving them in the work piece
- Supplied in the TengTools TCW807N 7 drawer roller cabinet
- A comprehensive selection of tools using 5 of the available 7 drawers ensuring that space is still available to add to the kit if needed

Drawer	Item ID	Description
Storage	TCW807N	Tool Box Roller Cabinet 7 Drawer
1/7	TTESK86	1/4" & 3/8" Socket Set FOAM4X4 86 Pieces
2/7	TTEX23N	Nut Driver T-Handle Set FOAM4X4 23 Pieces
3/7	TTESP31	Combination Spanner Set FOAM4X4 31 Pieces
4/7	TTEMB17	Plier Set FOAM4X4 17 Pieces
5/7	TTEMD122N	Screwdriver Set Mixed FOAM4X4 122 Pieces

Item ID: **TCMME09C**

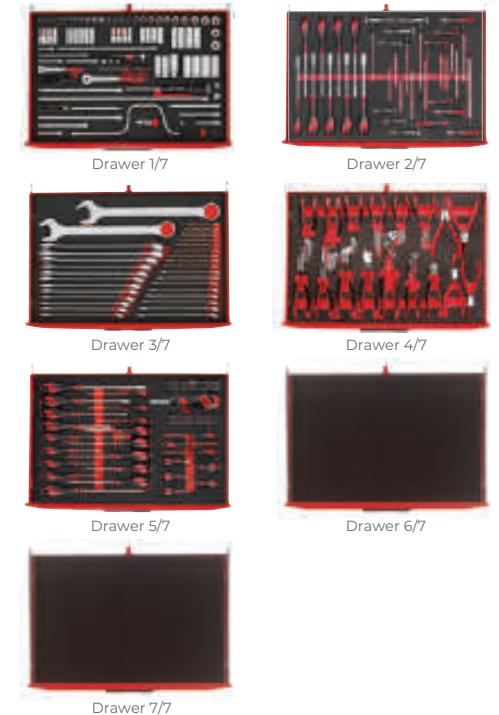

Drawer 1/7 Drawer 2/7
 Drawer 3/7 Drawer 4/7
 Drawer 5/7 Drawer 6/7
 Drawer 7/7

FOAM SERIES



- 7 Drawer
- 26" Wide Cabinet
- Heavy Gauge Steel
- 5-Step Rust Protection
- 5" Castor Wheels with Brakes
- 3 Step Ball Bearing Slides
- Key Lock

179 Pieces 69 kg

26" STD CABINET FOAM TOOL KIT 179 PIECES

- All the tools are laid out in 3 colour pre-cut EVA foam trays with each tool having it's own place
- Clearly shows if any tools are not in their correct place to prevent losing tools or leaving them in the work piece
- Supplied in the TengTools TCW707EV 7 drawer roller cabinet
- A comprehensive selection of tools using just 3 of the available 7 drawers ensuring that space is still available to add to the kit if needed

Drawer	Item ID	Description
Storage	TCW707EV	Tool Box Roller Cab 7 Drawer SV Type
1/7	TTEPS25	General Tool Set FOAM4X4 25 Pieces
2/7	TTESK126	1/4" & 1/2" Socket Set 6 pt FOAM4X4 126 Pieces
3/7	TTESP28	General Tool Set FOAM4X4 28 Pieces

Item ID: TCMME179



Drawer 1/7



Drawer 2/7



Drawer 3/7

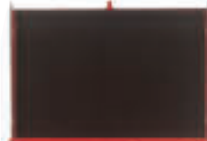

Drawer 4/7



Drawer 5/7



Drawer 6/7



Drawer 7/7



FOAM SERIES



- 7 Drawer
- 26" Wide Cabinet
- Heavy Gauge Steel
- 5-Step Rust Protection
- 5" Castor Wheels with Brakes
- 3 Step Ball Bearing Slides
- Key Lock

174 Pieces 62 kg

26" STD CABINET FOAM TOOL KIT 174 PIECES

- All the tools are laid out in 3 colour pre-cut EVA foam trays with each tool having it's own place
- Clearly shows if any tools are not in their correct place to prevent losing tools or leaving them in the work piece
- Supplied in the TengTools TCW707EV 7 drawer roller cabinet with ABS top
- A comprehensive selection of tools using just 3 of the available 7 drawers ensuring that plenty of space is still available

Drawer	Item ID	Description
Storage	TCW707EV	Tool Box Roller Cab 7 Drawer SV Type
	ABS-TOP	ABS Top for Roller Cabinet
1/7	TTESK126	1/4" & 1/2" Socket Set 6 pt FOAM4X4 126 Pieces
2/7	TTEM33	Screwdriver & Spanner Set FOAM4X4 33 Pieces
3/7	TTEPS15	General Tool Set FOAM4X4 15 Pieces

Item ID: TCMME174



Drawer 1/7

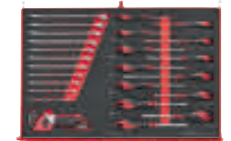

Drawer 2/7



Drawer 3/7



Drawer 4/7



Drawer 5/7



Drawer 6/7



Drawer 7/7



TT SERIES



1004 PIECE 8 DRAWER TOOL KIT BLACK

- 1004 piece Work Station tool kit
- A complete tool kit covering the requirements of most types of user
- All the tools are laid out in individual tool trays using the TengTools Get Organised system
- Easy to see if any tools have been mislaid or lost helping to prevent leaving them with the work piece
- Supplied in the Black TengTools extra wide TCW208NBK1 8 drawer 37" (950mm) wide roller cabinet finished in a high gloss black
- Work Top, Vice + vice shelf, magnetic bits tray and paper holder are included

- 8 Drawer**
- 37" Wide Cabinet**
- Heavy Gauge Steel**
- 5-Step Rust Protection**
- 5" Castor Wheels with Brakes**
- 3 Step Ball Bearing Slides**
- Comfort Grip Handle**
- Combination Lock**

1004 Pieces 138 kg



Drawer 1/8

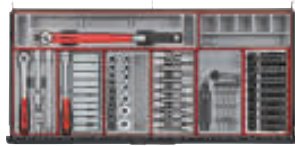

Drawer 2/8

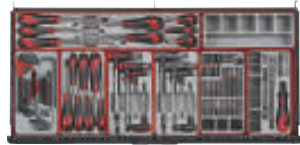

Drawer 3/8

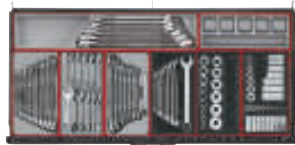

Drawer 4/8



Drawer 5/8



Drawer 6/8



Drawer 7/8

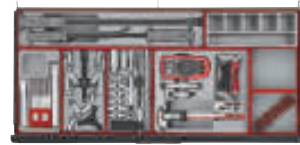

Drawer 8/8



Drawer	Item ID	Description
Storage	580	Magnetic Bits Tray
	TC-TB03	Work Top
	TCATV	Side Shelf for Vice
	TCAV4	4" Work Bench Vice
	TCA01	Paper Roll Holder
	TCW208NBK1	Tool Box Roller Cabinet 37in 8 Drawer
1/8	TTZ01	Storage Tray TTX2 6 Compartments
1/8	TTXEXT13	Extension Bars Set TTX4 13 Pieces
1/8	TT1435	1/4" Socket Set 6 pt TT1 35 Pieces
1/8	TT3819	3/8" Socket Set 6 pt TT1 19 Pieces
1/8	TTADP17	Socket Adaptor Set TT1 17 Pieces
1/8	TTTX30	3/8" TX Bit Socket Set TT1 30 Pieces
1/8	TT3816	3/8" Socket Set 6 pt TT1 16 Pieces
1/8	TT9015HX	3/8" & 1/2" Hex Impact Skt Set DIN TT1 15 Pieces
2/8	TTZ01	Storage Tray TTX2 6 Compartments
2/8	TTX1292	1/2" Torque Wrench 40-210 Nm TTX4
2/8	TT1205	1/2" Ratchet & Accessories Set TT1 5 Pieces
2/8	TT1217-6	1/2" Socket Set 6 pt TT1 17 Pieces
2/8	TT9116N	1/2" Impact Socket Set ANSI TT1 16 Pieces
2/8	TTHEX16	1/2" Hex Bit Socket Set TT1 16 Pieces
2/8	TT1211	1/2" Socket Set 12 pt TT1 11 Pieces
2/8	TTID20	1/2" Impact Driver Set TT1 20 Pieces
3/8	TTZ01	Storage Tray TTX2 6 Compartments
3/8	TTX918N	Screwdriver Set Flat & PH TTX4 8 Pieces
3/8	TTTX7	T-Handle TX/TPX Key Set TT1 7 Pieces
3/8	TTHEX7	T-Handle Ball Point Hex Key Set TT1 7 Pieces
3/8	TT917TXN	Screwdriver Set TX & TPX TT1 7 Pieces
3/8	TTB553	Impact Bit Set TT1 53 Pieces
3/8	TTMDR84	Ratcheting Bits Driver Set TT1 84 Pieces
3/8	TTHT28	Ball Point Hex & TX Key Set TT1 28 Pieces
4/8	TTZ01	Storage Tray TTX2 6 Compartments
4/8	TTX2032	Combination Spanner Set TTX4 7 Pieces
4/8	TT1236	Combination Spanner Set TT1 12 Pieces
4/8	TT6010M	Stubby Combination Spanner Set TT1 10 Pieces
4/8	TT6508R	Ratcheting Spanner Set R TT1 8 Pieces
4/8	TT3592	Combination Spanner Set AF TT1 8 Pieces
4/8	TT1215AF	1/2" Socket Set 12 pt AF TT1 15 Pieces
4/8	TTAF32	1/4" & 3/8" Socket Set AF 6 pt TT1 32 Pieces

Drawer	Item ID	Description
5/8	TTZVG03	Power Grip Plier Set TTX2 3 Pieces
5/8	TTX474-9	Circlip Plier Set 40-100 mm TTX4 4 Pieces
5/8	TTM116	Mini Pliers & Screwdriver Set TT1 16 Pieces
5/8	TT474-7	Circlip Plier Set 19-60 mm TT1 4 Pieces
5/8	TTD441-T	Plier Set TPR Grip TT2 8 Pieces
5/8	TTHR81	Rivet Gun Set TT1 81 Pieces
5/8	TTNR81	Nutsert Gun Set TT1 81 Pieces
6/8	TTZ01	Storage Tray TTX2 6 Compartments
6/8	TTX3892	3/8" Torque Wrench Set TTX4 22 Pieces
6/8	TTD914N	Screwdriver Set Mixed TT2 14 Pieces
6/8	TTMDQ49	Bits Driver Set TT1 49 Pieces
6/8	TTV907N	Insulated Screwdriver Set Mixed TT1 7 Pieces
6/8	TTV440	Insulated Plier Set TT1 4 Pieces
6/8	TTCP121	Crimping Plier Set TT1 121 Pieces
7/8	TTZ01	Storage Tray TTX2 6 Compartments
7/8	TTX2640	Combination Spanner Set AF TTX4 7 Pieces
7/8	TTPS09	General Tool Set BP TT4 9 Pieces
7/8	TTSR04	Scraper Set TT1 4 Pieces
7/8	TTTM03	Inspection Set TT1 3 Pieces
8/8	TTZ01	Storage Tray TTX2 6 Compartments
8/8	TTXPB3A	Pry Bar SetTTX4 3 Pieces
8/8	TTPC09	Punch & Chisel Set TT1 9 Pieces
8/8	TT804	Puller Set TT1 4 Pieces
8/8	TTOS16	Oil Service Set TT1 16 Pieces
8/8	TTDAM	Measuring Tool Set TT2 4 Pieces Discontinued
8/8	TT00	Storage Tray With Tool Holder TT1

Item ID: **TCMM1004NBK1**



TT
SÉRIES



**26" PRO CABINET WORKSTATION TT TOOL KIT
545 PIECES RED**

- A complete tool kit combined with a top plate and back panels to create a work station
- The tools are laid out in individual tool trays using the TengTools Get Organised system
- The most commonly used tools are supplied in wall racks to keep them handy at the work station
- Easy to see if any tools have been mislaid or lost helping to prevent leaving them with the work piece
- Supplied in a red TengTools TCW807N 7 drawer roller cabinet complete with work top and panels
- A comprehensive selection of tools using 6 of the available 7 drawers ensuring that space is still available to add to the kit if needed

- 7 Drawer**
- 26" Wide Cabinet**
- Heavy Gauge Steel**
- 5-Step Rust Protection**
- 5" Castor Wheels with Brakes**
- 3 Step Ball Bearing Slides**
- Comfort Grip Handle**
- Combination Lock**

545
Pieces 91.2 kg

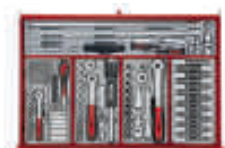

Drawer 1/7



Drawer 2/7

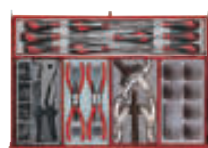

Drawer 3/7



Drawer 4/7



Drawer 5/7



Drawer 6/7



Drawer 7/7

Drawer	Item ID	Description
Storage	TCW807N	Tool Box Roller Cabinet 7 Drawer
Panel	WRFL05	Hand File Set Wall Rack 5 Pieces
	WRMB04	Plier Set Wall Rack 4 Pieces
	WRMD10N	Screwdriver Set Wall Rack 10 Pieces
	WRSP12	Combination Spanner Set 8-19 mm Wall Rack 12 Pieces
1/7	TTXEXT13	Extension Bars Set TTX4 13 Pieces
1/7	TT1435	1/4" Socket Set 6 pt TT1 35 Pieces
1/7	TT3819	3/8" Socket Set 6 pt TT1 19 Pieces
1/7	TT1218	1/2" Socket Set 12 pt TT1 118 Pieces
1/7	TTXHI15	1/2" Hex & TX Bit Socket Set TT1 15 Pieces
2/7	TTXMDTN	Power Through Screwdriver Set TTX4 5 Pieces
2/7	TTMD74	Ratcheting Screwdriver Bit Set TT1 74 Pieces
2/7	TT917TXN	Screwdriver Set TX & TPX TT1 7 Pieces
2/7	TTHEX7	T-Handle Ball Point Hex Key Set TT1 7 Pieces
2/7	TTTX7	T-Handle TX/TPX Key Set TT1 7 Pieces
3/7	TTXND	Nut Driver Set TTX4 9 Pieces
3/7	TTHR81	Rivet Gun Set TT1 81 Pieces
3/7	TT474-7	Circlip Plier Set 19-60 mm TT1 4 Pieces
3/7	TT804	Puller Set TT1 4 Pieces
3/7	TT01	Storage Tray TT1 7 Compartments
4/7	TTX00	Storage Tray TTX4 1 Compartment
4/7	TTPC09	Punch & Chisel Set TT1 9 Pieces
4/7	TTCP121	Crimping Plier Set TT1 121 Pieces
4/7	TTDTD34	Tap and Die Set TT2 34 Pieces
5/7	TTX2032	Combination Spanner Set TTX4 7 Pieces
5/7	TTDCT05	Cutting Tool Set TT2 5 Pieces
5/7	TTTM08	inspection Set TT1 8 Pieces
5/7	TTBM	Measuring Tool Set TT1 4 Pieces
6/7	TTX01	Storage Tray TTX4 6 Compartments
6/7	TTPS09E	General Tool Set E TT4 9 Pieces

Item ID: **TCMM545N**



TT SERIES



26" STD TOP BOX TT STARTER KIT 20 PIECES

- Mechanics starter kit built up using the TengTools Get Organised tool tray system
- Supplied in a 6 drawer red top box with 3 full width drawers and 3 smaller drawers secured with a key lock
- Drop front with the TengTools logo to cover the drawers when the box is closed

- 6 Drawer**
- 26" Wide Box**
- Heavy Gauge Steel**
- 5-Step Rust Protection**
- 3 Step Ball Bearing Slides**
- Key Lock**

20 Pieces 26 kg

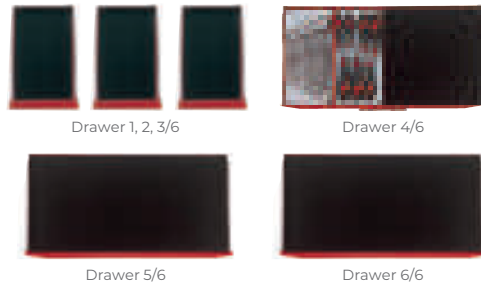

Drawer	Item ID	Description
Storage	TC806SV	Tool Box Top Box 6 Drawer SV Series
4/6	TT1236	Combination Spanner Set TTI 12 Pieces
4/6	TT917N	Screwdriver Set Mixed TTI 7 Pieces

Item ID: **TC820SV**

TT SERIES



26" PRO TOP BOX TT TOOL KIT 140 PIECES

- A comprehensive mechanics starter kit built up using the TengTools Get Organised tool tray system
- Supplied in a 6 drawer red top box with 3 full width drawers and 3 smaller drawers secured with a combination lock
- Drop front with the TengTools logo to cover the drawers when the box is closed
- A handy lightweight plastic and aluminium tote tray is included for taking tools to the job in hand

- 6 Drawer**
- 26" Wide Box**
- Heavy Gauge Steel**
- 5-Step Rust Protection**
- 3 Step Ball Bearing Slides**
- Comfort Grip Handle**
- Combination Lock**

140 Pieces 42 kg



Drawer	Item ID	Description
Storage	TC806NF	Tool Box Top Box 6 Drawer
4/6	TT1435	1/4" Socket Set 6 pt TTI 35 Pieces
4/6	TT3819	3/8" Socket Set 6 pt TTI 19 Pieces
4/6	TT1217	1/2" Socket Set 12 pt TTI 17 Pieces
4/6	TT1205	1/2" Ratchet & Accessories Set TTI 5 Pieces
5/6	TT1236	Combination Spanner Set TTI 12 Pieces
5/6	TT917N	Screwdriver Set Mixed TTI 7 Pieces
5/6	TT440-T	Plier Set TPR Grip TTI 4 Pieces
5/6	TTALU	Clip Rail Set TTI 32 Pieces
6/6	TTPS09	General Tool Set BP TT4 9 Pieces

Item ID: **TC8140NF**

26" PRO TOP BOX TT TOOL KIT 140 PIECES

- A comprehensive mechanics starter kit built up using the TengTools Get Organised tool tray system
- Supplied in a 6 drawer red top box with 3 full width drawers and 3 smaller drawers secured with a combination lock
- Drop front with the TengTools logo to cover the drawers when the box is closed
- A handy lightweight plastic and aluminium tote tray is included for taking tools to the job in hand

Drawer	Item ID	Description
Storage	TC806NBK	Tool Box Top Box 6 Drawer Black
4/6	TT1435	1/4" Socket Set 6 pt TTI 35 Pieces
4/6	TT3819	3/8" Socket Set 6 pt TTI 19 Pieces
4/6	TT1217	1/2" Socket Set 12 pt TTI 17 Pieces
4/6	TT1205	1/2" Ratchet & Accessories Set TTI 5 Pieces
5/6	TT1236	Combination Spanner Set TTI 12 Pieces
5/6	TT917N	Screwdriver Set Mixed TTI 7 Pieces
5/6	TT440-T	Plier Set TPR Grip TTI 4 Pieces
5/6	TTALU	Clip Rail Set TTI 32 Pieces
6/6	TTPS09	General Tool Set BP TT4 9 Pieces

Item ID: **TC8140P**

A Personalised Tool Box Sticker

This is now available to you through your local stockist. Provide an image that you would like to use and we will customise your tool kit for you. Images need to be supplied as high resolution jpeg, eps, PDF, or ai vector format.

TT SERIES



- 6 Drawer**
- 26" Wide Box**
- Heavy Gauge Steel**
- 5-Step Rust Protection**
- 3 Step Ball Bearing Slides**
- Comfort Grip Handle**
- Combination Lock**

140 Pieces 42 kg





FOAM SERIES



26" PRO TOP BOX FOAM TOOL KIT 280 PIECES

- A complete tool kit covering many of the requirements of most types of user
- All the tools are laid out in 3 colour pre-cut EVA foam trays with each tool having it's own place
- Clearly shows if any tools are not in their correct place to prevent losing tools or leaving them in the work piece
- Supplied in the TengTools TC805NFX full depth 5 drawer top box

Drawer	Item ID	Description
Storage	TC805NFX	Tool Box Top Box 5 Drawer
1/5	TTESK86	1/4" & 3/8" Socket Set FOAM4X4 86 Pieces
2/5	TTEX23N	Nut Driver T-Handle Set FOAM4X4 23 Pieces
3/5	TTESP31	Combination Spanner Set FOAM4X4 31 Pieces
4/5	TTEMB17	Plier Set FOAM4X4 17 Pieces
5/5	TTEMD122N	Screwdriver Set Mixed FOAM4X4 122 Pieces

Item ID: TCMME09B

- 5 Drawer
- 26" Wide Cabinet
- Heavy Gauge Steel
- 5-Step Rust Protection
- 3 Step Ball Bearing Slides
- Comfort Grip Handle
- Combination Lock

280 Pieces 67.8 kg



Drawer 1/5

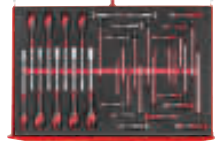

Drawer 2/5



Drawer 3/5



Drawer 4/5

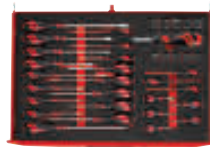

Drawer 5/5

PORTABLE TOOL KITS

TOOLS ON THE MOVE

When a machine has stopped working or a vehicle is in need of urgent repair no time can be wasted searching for the right tools. A fully organised, portable tool kit is essential.

Our service cases come in different sizes, and store the sets from the TengTools Tool Control System neatly and securely, allowing easy access to all tools when you need them.



MECCA PRO™

TT SERIES



113 Pieces 12.9 kg



MECCA PRO TC-9 TT TOOL KIT 113 PIECES

- Ideal for technicians
- Supplied in the unique TengTools TC-SC service case with the tools supplied in 9 TengTools TT1 trays
- Hard wearing flight case style carrying case with a combination lock and secure catches
- Complete with fixed castor wheels and retractable handle for easy carrying

Section	Item ID	Description
1/3	TT1217	1/2" Socket Set 12 pt TT1 17 Pieces
1/3	TT1236	Combination Spanner Set TT1 12 Pieces
1/3	TT440-T	Plier Set TPR Grip TT1 4 Pieces
2/3	TT917N	Screwdriver Set Mixed TT1 7 Pieces
2/3	TT917TXN	Screwdriver Set TX & TPX TT1 7 Pieces
2/3	TTHEX7	T-Handle Ball Point Hex Key Set TT1 7 Pieces
3/3	TT1435	1/4" Socket Set 6 pt TT1 35 Pieces
3/3	TT3819	3/8" Socket Set 6 pt TT1 19 Pieces
3/3	TT1205	1/2" Ratchet & Accessories Set TT1 5 Pieces

Item ID: SC01

MECCA PRO™

TT SERIES



232 Pieces 10.3 kg



MECCA PRO TC-9 TT TOOL KIT 232 PIECES

- Supplied in the unique TengTools TC-SC service case with the tools supplied in 9 TengTools TT1 trays
- Hard wearing flight case style carrying case with a combination lock and secure catches
- Complete with fixed castor wheels and retractable handle for easy carrying

Section	Item ID	Description
1/3	TT440	Plier Set Vinyl Grip TT1 4 Pieces
1/3	TTM16	Mini Pliers & Screwdriver Set TT1 16 Pieces
1/3	TTCP121	Crimping Plier Set TT1 121 Pieces
2/3	TTTM03	Inspection Set TT1 3 Pieces
2/3	TTNF12	Needle File Set TT1 12 Pieces
2/3	TTDB28	Drill Bit Set 1.0-13.0 mm TT2 28 Pieces
3/3	TT6508R	Ratcheting Spanner Set R TT1 8 Pieces
3/3	TTHT28	Ball Point Hex & TX Key Set TT1 28 Pieces
3/3	TTMD12D	Screwdriver Blade Set Mixed TT1 12 Pieces

Item ID: SC02

MECCA PRO™

TT SERIES



193 Pieces 10.8 kg



MECCA PRO TC-9 FOAM TOOL KIT 193 PIECES

- Supplied in the unique TengTools TC-SC service case with the tools supplied in 9 TengTools TT1 trays
- Hard wearing flight case style carrying case with a combination lock and secure catches
- Complete with fixed castor wheels and retractable handle for easy carrying

Section	Item ID	Description
1/3	TT440	Plier Set Vinyl Grip TT1 4 Pieces
1/3	TTM16	Mini Pliers & Screwdriver Set TT1 16 Pieces
1/3	TTMD12D	Screwdriver Blade Set Mixed TT1 12 Pieces
2/3	TT917N	Screwdriver Set Mixed TT1 7 Pieces
2/3	TT917TXN	Screwdriver Set TX & TPX TT1 7 Pieces
2/3	TTMD74	Ratcheting Screwdriver Bit Set TT1 74 Pieces
3/3	TT1435	1/4" Socket Set 6 pt TT1 35 Pieces
3/3	TTBS35	1/4" & 3/8" Bit Socket Set TT1 35 Pieces
3/3	TTTM03	Inspection Set TT1 3 Pieces

Item ID: SC03

MECCA PRO™

TT SERIES



100 Pieces 15.3 kg



MECCA PRO TC-9 TT TOOL KIT 100 PIECES

- Supplied in the unique TengTools TC-SC service case with the tools supplied in 6 TengTools TT1 trays and a TT3 tray
- Hard wearing flight case style carrying case with a combination lock and secure catches
- Complete with fixed castor wheels and retractable handle for easy carrying

Section	Item ID	Description
1/3	TT1236	Combination Spanner Set TT1 12 Pieces
1/3	TT917N	Screwdriver Set Mixed TT1 7 Pieces
1/3	TT440-T	Plier Set TPR Grip TT1 4 Pieces
2/3	SCPS01	General Tool Set BP TT3 6 Pieces
3/3	TT1435	1/4" Socket Set 6 pt TT1 35 Pieces
3/3	TT3819	3/8" Socket Set 6 pt TT1 19 Pieces
3/3	TT1218	1/2" Socket Set 12 pt TT1 118 Pieces

Item ID: SC04

MECCA PRO™

TT
SERIES



100 Pieces 12.9 kg



MECCA PRO TC-9 TT TOOL KIT E 100 PIECES

- Supplied in the unique TengTools TC-SC service case with the tools supplied in 6 TengTools TT1 trays and a TT3 tray
- Hard wearing flight case style carrying case with a combination lock and secure catches
- Complete with fixed castor wheels and retractable handle for easy carrying

Section	Item ID	Description
1/3	TT1236	Combination Spanner Set TT1 12 Pieces
1/3	TT917N	Screwdriver Set Mixed TT1 7 Pieces
1/3	TT440-T	Plier Set TPR Grip TT1 4 Pieces
2/3	SCPS01E	General Tool Set E TT3 6 Pieces
3/3	TT1435	1/4" Socket Set 6 pt TT1 35 Pieces
3/3	TT3819	3/8" Socket Set 6 pt TT1 19 Pieces
3/3	TT1218	1/2" Socket Set 12 pt TT1 118 Pieces

Item ID: **SC04E**

MECCA PRO™

FOAM
SERIES



118 Pieces 11.8 kg



MECCA PRO TC-9 FOAM TOOL KIT 118 PIECES

- Supplied in the unique TengTools TC-SC service case with the tools supplied in 3 FOAM3 sets especially designed to fit the service case
- Tools are held in place using three colour pre-cut EVA foam clearly showing where each tool belongs
- Hard wearing flight case style carrying case with a combination lock and secure catches
- Complete with fixed castor wheels and retractable handle for easy carrying

Section	Item ID	Description
1/3	TEFMD54	Screwdriver, Hex Key & MM Tape FOAM3 54 Pieces
2/3	TEFMB7	General Tool Set Carpenters Hammer FOAM3 7 Pieces
3/3	TEFSK57	Spanner & Socket Set FOAM3 57 Pieces

Item ID: **SCE1**

MECCA PRO™

FOAM
SERIES



118 Pieces 12 kg



MECCA PRO TC-9 FOAM BP TOOL KIT 118 PIECES

- Supplied in the unique TengTools TC-SC service case with the tools supplied in 3 FOAM3 sets especially designed to fit the service case
- Tools are held in place using three colour pre-cut EVA foam clearly showing where each tool belongs
- Hard wearing flight case style carrying case with a combination lock and secure catches
- Complete with fixed castor wheels and retractable handle for easy carrying

Section	Item ID	Description
1/3	TEFMDI54	Screwdriver, Hex Key & MM/AF Tape FOAM3 54 Pieces
2/3	TEFMBP7	General Tool Set Ball Pein Hammer FOAM3 7 Pieces
3/3	TEFSK57	Spanner & Socket Set FOAM3 57 Pieces

Item ID: **SCE2**



NEW

MECCA PRO™
TT
SERIES



114
Pieces

MECCA PRO TC-6 TT TOOL KIT 114 PIECE

- Supplied in the unique TengTools TC-6T service case with the tools supplied in 6 TengTools TT1 trays.
- Hard wearing carrying case with distinctive branding.
- Robust moulded body with built in strength and durability.
- Handle on side make it easy to carry

Section	Item ID	Description
1/2	TT440	Plier Set Vinyl Grip TT1 4 Pieces
1/2	TTHT28	Ball Point Hex & TX Key Set TT1 28 Pieces
1/2	TT01	Storage Tray TT1 7 Compartments
2/2	TT3819	3/8" Socket Set 6 pt TT1 19 Pieces
2/2	TT1236	Combination Spanner Set TT1 12 Pieces
2/2	TTMDQ49	Bits Driver Set TT1 49 Pieces

Item ID: **TC-6T01**

NEW

MECCA PRO™
FOAM
SERIES



112
Pieces

MECCA PRO TC-6 FOAM TOOL KIT 112 PIECE

- Supplied in the unique TengTools TC-6T service case with the tools supplied in 2 FOAM3 sets.
- Tools held in place using three colour pre-cut EVA foam clearly showing where each tool belongs.
- Hard wearing carrying case with distinctive branding.
- Robust moulded body with built in strength and durability.
- Handle on side make it easy to carry

Section	Item ID	Description
1/2	TEFMDI54	Screwdriver, Hex Key & MM/AF Tape FOAM3 54 Pieces
2/2	TEFSK57	Spanner & Socket Set FOAM3 57 Pieces

Item ID: **TC-6TE01**

NEW



105
Pieces

HEAVY DUTY TOOL SET BP HAMMER 105 PIECES

- 6 point 1/2" drive single hexagon sockets for a better grip
- Chrome vanadium satin finish sockets and spanners
- Combination spanners, adjustable wrenches, pliers, ball peen hammer and bits
- Supplied in a hard wearing case
- Tools clearly laid out to easily identify which tool belongs where
- Design and manufactured to DIN and ISO standards

General Tools:	
Combination Spanners:	8, 10, 11, 12, 13, 14, 15, 16, 17, 18, 19, 21, 22, 24, 25, 26, 27, 30, 32 mm
Striking Tools:	24oz Ball peen hammer
Pliers:	6" Side cutter, 7" Heavy Duty combination plier, 10" Quick Set water pump plier
Drivers:	9 Piece mm hex key set, Ratcheting bits driver set, Flat tip screwdriver, 29 Piece bits set, 7mm ball point hex key
Wrenches:	6" & 12" Adjustable wrenches
Service Tools:	125° Hook tool, Telescopic magnetic pick up tool and pen
1/2" Drive 17" Flex Handle	
1/2" Drive FRP ratchet, 5" Extension bar	
1/2" Drive 6 point sockets:	
Reg mm:	8 10 12 13 14 15 16 17 18 19 21 22 24 25 26 27 30 32
1/2" Drive Hex bit sockets:	
mm:	5 6 7 8 10 12 14 17 19

Item ID: **THDV105**

NEW



105
Pieces

HEAVY DUTY TOOL SET E HAMMER 105 PCS

- 6 point 1/2" drive single hexagon sockets for a better grip
- Chrome vanadium satin finish sockets and spanners
- Combination spanners, adjustable wrenches, pliers, engineers hammer and bits
- Supplied in a hard wearing case
- Tools clearly laid out to easily identify which tool belongs where
- Design and manufactured to DIN and ISO standards

General Tools:	
Combination Spanners:	8, 10, 11, 12, 13, 14, 15, 16, 17, 18, 19, 21, 22, 24, 25, 26, 27, 30, 32 mm
Striking Tools:	800g Engineers hammer
Pliers:	6" Side cutter, 7" Heavy Duty combination plier, 10" Quick Set water pump plier
Drivers:	9 Piece mm hex key set, Ratcheting bits driver set, Flat tip screwdriver, 29 Piece bits set, 7mm ball point hex key
Wrenches:	6" & 12" Adjustable wrenches
Service Tools:	125° Hook tool, Telescopic magnetic pick up tool and pen
1/2" Drive 17" Flex Handle	
1/2" Drive FRP ratchet, 5" Extension bar	
1/2" Drive 6 point sockets:	
Reg mm:	8 10 12 13 14 15 16 17 18 19 21 22 24 25 26 27 30 32
1/2" Drive Hex bit sockets:	
mm:	5 6 7 8 10 12 14 17 19

Item ID: **THDV105E**



187 Pieces

BARN STYLE TOOL BOX TOOL KIT 187 PIECES

- A comprehensive selection of tools for mechanics
- Supplied in the TengTools Mega Rosso barn style tool box with aluminium clip rails and tools storage areas
- Padlock facility and full length piano hinges with turned edges for added safety

1/4" Drive	30 socket clips, FRP ratchet, universal joint, 2" & 4" extensions, 3/8"F:1/4"M adaptor, coupler adaptor
3/8" Drive	30 socket clips, FRP ratchet, universal joint, 6" extension, 1/2"F:3/8"M adaptor
1/2" Drive	30 socket clips, FRP ratchet, universal joint, 2-1/2" and 6" extensions, 3/8"F:1/2"M adaptor
1/4" Drive 6 point sockets:	
Regular:	4, 5, 5.5, 6, 7, 8, 10, 11, 12, 13mm
Deep:	6, 7, 8, 10, 12, 13mm
3/8" Drive 6 point sockets:	
Regular:	8, 9, 10, 11, 12, 13, 14, 15, 16, 17, 18, 19, 21, 22mm
1/2" Drive 12 point sockets:	
Regular:	10, 11, 12, 13, 14, 15, 16, 17, 18, 19, 21, 22, 24, 27, 30, 32mm
1/4" Hex Bits:	TX8, TX10, TX15, TX20, TX25, TX27, TX30, TX40, 3mm, 4mm, 5mm, 6mm, 7mm, 8mm, 10mm Hex, PH1, PH2, PZ1, PZ2, 4mm, 5.5mm, 7mm flat
Spanners:	8, 10, 11, 12, 13, 14, 15, 17, 19mm Ring holder
Hex Keys:	1.5, 2.0, 2.5mm hex keys

Item ID: **TC187**



144 Pieces

CANTILEVER BOX TOOL KIT 144 PIECES

- A comprehensive selection of tools for service technicians
- Supplied in the TengTools 5 drawer cantilever tool box (TC540)
- Padlock facility and full length piano hinges with turned edges for added safety

1/4" Drive	FRP ratchet, universal joint, 2" and 4" extension bars, coupler adaptor, 3/8"F:1/4"M adaptor
1/2" Drive	FRP ratchet, universal joint, 2½" and 6" extension bars, 3/8"F:1/2"M T bar adaptor
1/4" Drive 6 point sockets:	
Regular:	4, 5, 5.5, 6, 7, 8, 10, 11, 12, 13mm
Deep:	6, 7, 8, 10, 12, 13mm
1/2" Drive 12 point sockets:	
Regular:	10, 11, 12, 13, 14, 15, 16, 17, 18, 19, 21, 22, 24, 27, 30, 32mm
1/4" Hex Bits:	TX10, TX15, TX20, 5mm hex, 6mm hex, PH1, PH2, PZ1, PZ2, 4mm flat, 5.5mm flat
Spanners:	5.5, 6, 7, 8, 9, 10, 11, 12, 13, 14, 15, 16, 17, 18, 19mm
Hex Keys:	9 piece ball point hex key set, 1.5, 2.0 & 2.5mm hex keys, 10" adjustable wrench
Screwdrivers:	3.5mm, 5.5mm & 6.5mm flat, PH0, PH1, PH2, PZ0, PZ1, PZ2, 4mm flat 1000 volt insulated
Pliers:	8" combination, 8" long nose, 10" water pump, 6" side cutters, 8" side cutters, 10" power grip
Service Tools:	Drill bit set, magnetic lamp, measuring tape, hacksaw with spare blades, utility knife, centre punch, parallel pin punch set, soft face hammer, ball pein hammer, tin snips, magnetic bracelet

Item ID: **TC144D**



Top

Drawer 1

Drawer 2

35 Pieces

MINI TOP BOX TOOL KIT 35 PIECES RED

- A selection of general hand tools in PS trays
- Supplied in a 2 drawer mini top box with 2 small drawers and storage space in the top compartment
- Drop front with the TengTools logo to cover the drawers when the box is closed

Contents:	
Drawer Number	Description
Top	1/4" drive regular sockets: 4, 5, 5.5, 6, 7, 8, 10, 12, 13mm 1/4" drive 2" extension, 1/4" bit ratchet 1/4" hex adaptor 1/4" hex bits: 4, 5.5, 6.5mm flat, PH1, PH2, PZ1, PZ2, TX10, TX15, TX20 Fold up bicycle tool set 4" Adjustable Wrench
Drawer 1	6" side cutter, 7" High leverage combination plier
Drawer 2	Combination spanners: 8, 9, 10, 11, 12, 13mm Screwdrivers: flat 5.5x75mm, PH1x75mm, insulated PH1 X 80mm

Item ID: **TM035NF**



144 Pieces

BACK PACK TOOL KIT 144 PIECES

- A comprehensive selection of tools for service technicians
- Supplied in the TengTools back pack for tools (TC5B)
- Shoulder straps and carrying handles make the kit easy to carry around
- Manufactured in polyester with an EVA plastic base, external pockets and a large internal compartment

1/4" Drive	FRP ratchet, universal joint, 2" and 4" extension bars, coupler adaptor, 3/8"F:1/4"M adaptor
1/2" Drive	FRP ratchet, universal joint, 2½" and 6" extension bars, 3/8"F:1/2"M T bar adaptor
1/4" Drive 6 point sockets:	
Regular:	4, 5, 5.5, 6, 7, 8, 10, 11, 12, 13mm
Deep:	6, 7, 8, 10, 12, 13mm
1/2" Drive 12 point sockets:	
Regular:	10, 11, 12, 13, 14, 15, 16, 17, 18, 19, 21, 22, 24, 27, 30, 32mm
1/4" Hex Bits:	TX10, TX15, TX20, 5mm hex, 6mm hex, PH1, PH2, PZ1, PZ2, 4mm flat, 5.5mm flat
Spanners:	5.5, 6, 7, 8, 9, 10, 11, 12, 13, 14, 15, 16, 17, 18, 19mm
Wrenches:	9 piece ball point hex key set, 1.5, 2.0 & 2.5mm hex keys, 10" adjustable wrench
Screw-drivers:	3.5mm, 5.5mm & 6.5mm flat, PH0, PH1, PH2, PZ0, PZ1, PZ2, 4mm flat 1000 volt insulated
Pliers:	8" combination, 8" long nose, 10" water pump, 6" side cutters, 8" side cutters, 10" power grip
Service Tools:	Drill bit set, magnetic lamp, measuring tape, hacksaw with spare blades, utility knife, centre punch, parallel pin punch set, soft face hammer, ball pein hammer, tin snips, magnetic bracelet

Item ID: **TC144E**







TOOL STORAGE

BUILT TO LAST

TengTools tool boxes and tool cabinets have been designed to meet the high demands made by professionals from all over the world. No details are left to chance when our tool boxes and roller cabinets are manufactured.

A full range of storage accessories, side tables, side drawers and tool panels are available and can be placed on both sides of all TengTools roller cabinets.



-  All of our tool storage is manufactured from heavy gauge, top quality steel. They are built to last!
-  During the manufacturing process our tool storage is powder coat painted with a 5-step rust prevention and undercoat
-  Improved combination locking system for extra security on all PRO tool boxes and roller cabinets.
-  All drawers are equipped with robust 3-step ball bearing slides allowing them to be fully extended easily to gain greater access to the tools
-  Comfort grip handles. These top & middle boxes are supplied with rubber coated side handles while these tool cabinets are equipped with rubber soft grip transport handles
-  Cabinets are fitted with castor wheels covered with high-quality rubber. Two fixed and two swivel with brakes. Fitted in a U-shaped bracket providing extra strength and stability.





26" PRO STACK 16 DRAWERS RED

- A 6 drawer top box (TC806NF) 3 drawer middle box (TC803N) and a 7 drawer roller cabinet (TCW807N) combined to create a stack system with 16 drawers
- Each full width drawer in the top and middle box is suitable for holding 4 TTI trays
- The roller cabinet drawers will also hold a TTX4 tray as well as the 4 TTI trays
- Each drawer is supplied with an EVA drawer mat
- A handy lightweight plastic and aluminium tote tray is included
- Drawers have ball bearing slides for a smoother and more reliable opening and closing action
- Use with the TengTools Get Organised system to build your ultimate tool kit

- 16 Drawer
- 26" Wide Cabinet
- Heavy Gauge Steel
- 5-Step Rust Protection
- 5" Castor Wheels with Brakes
- 3 Step Ball Bearing Slides
- Comfort Grip Handle
- Combination Lock

Item ID: TC816STACK

26" STD STACK 16 DRAWERS RED

- A 6 drawer top box (TC806SV) 3 drawer middle box (TC803SV) and a 7 drawer roller cabinet (TCW707EV) combined to create a stack system with 16 drawers
- Each full width drawer in the top and middle box is suitable for holding 4 TTI trays
- The roller cabinet drawers will also hold a TTX4 tray as well as the 4 TTI trays
- Drawers have ball bearing slides for a smoother and more reliable opening and closing action
- Use with the TengTools Get Organised system to build your ultimate tool kit

- 16 Drawer
- 26" Wide Cabinet
- Heavy Gauge Steel
- 5-Step Rust Protection
- 5" Castor Wheels with Brakes
- 3 Step Ball Bearing Slides
- Key Lock

Item ID: TC816SV



26" PRO STACK 19 DRAWERS BLACK

- A 6 drawer top box (TC806NBK) that can be personalised, a 3 drawer middle box (TC803NBK) and a 10 drawer roller cabinet (TCW810NBK) combined to create a stack system with 19 drawers
- Each full width drawer in the top and middle box is suitable for holding 4 TTI trays
- The roller cabinet drawers will also hold a TTX4 tray as well as the 4 TTI trays
- Each drawer is supplied with an EVA drawer mat
- A handy lightweight plastic and aluminium tote tray is included
- Drawers have ball bearing slides for a smoother and more reliable opening and closing action
- Use with the TengTools Get Organised system to build your ultimate tool kit

- 19 Drawer
- 26" Wide Cabinet
- Heavy Gauge Steel
- 5-Step Rust Protection
- 5" Castor Wheels with Brakes
- 3 Step Ball Bearing Slides
- Comfort Grip Handle
- Combination Lock

ITEM ID:	Description
TC819NBK	Black Tool Kit with TengTools Logo sticker
TC819BK	Black Tool Kit with a custom tool box sticker



A Personalised Tool Box Sticker

This is now available to you through your local stockist. Provide an image that you would like to use and we will customise your tool kit for you. Images need to be supplied as high resolution jpeg, eps, PDF, or ai vector format.



53" PRO STACK 16 DRAWERS RED

- A 10 drawer top box (TC810N) and a 6 drawer roller cabinet (TCW806LN) combined to create a stack system with 16 drawers
- The full width drawers are suitable for holding 8 TengTools TTI trays plus 2 TTX4 trays
- Each drawer is supplied with an EVA drawer mat and plastic trimmed handle
- Drawers have ball bearing slides for a smoother and more reliable opening and closing action
- Use with the TengTools Get Organised system to build your ultimate tool kit

- 16** Drawer
- 53"** Wide Cabinet
- Heavy Gauge Steel**
- 5-Step Rust Protection**
- 6"** Castor Wheels with Brakes
- 3 Step Ball Bearing Slides**
- Comfort Grip Handle**
- Combination Lock**

Item ID: TCW816LNSTACK

26" PRO TOP BOX 6 DRAWERS RED

- Drop front with the TengTools logo to cover the drawers when the box is closed
- Each full width drawer is suitable for holding 4 TengTools TTI trays
- Supplied with an EVA drawer mat and plastic trimmed handle
- A handy lightweight plastic and aluminium tote tray is included
- Drawers have ball bearing slides for a smoother and more reliable opening and closing action
- Supplied with rubber feet to prevent it from sliding and to avoid scratching
- Use with the TengTools Get Organised system to build your ultimate tool kit

	Width mm	Depth mm	Height mm	Capacity kg
Overall	660	305	375	
Drawer 1	170	275	50	8
Drawer 2	170	275	50	8
Drawer 3	170	275	50	8
Drawer 4	569	275	50	30
Drawer 5	569	275	50	30
Drawer 6	569	275	75	30

Drawer thickness mm	0.7
Body frame thickness mm	
	0.8
Weight kg	23.4

- 6** Drawer
- 26"** Wide Box
- Heavy Gauge Steel**
- 5-Step Rust Protection**
- 3 Step Ball Bearing Slides**
- Comfort Grip Handle**
- Combination Lock**



Item ID: TC806NF



53" PRO STACK 19 DRAWERS RED

- A 10 drawer top box (TC810N) and a 9 drawer roller cabinet (TCW809N) combined to create a stack system with 19 drawers
- Each regular width drawer is suitable for holding 4 TengTools TTI trays plus a TTX4 tray
- The full width drawers are suitable for holding 8 TengTools TTI trays plus 2 TTX4 trays
- Each drawer is supplied with an EVA drawer mat and plastic trimmed handle
- Drawers have ball bearing slides for a smoother and more reliable opening and closing action
- Use with the TengTools Get Organised system to build your ultimate tool kit

- 19** Drawer
- 53"** Wide Cabinet
- Heavy Gauge Steel**
- 5-Step Rust Protection**
- 6"** Castor Wheels with Brakes
- 3 Step Ball Bearing Slides**
- Comfort Grip Handle**
- Combination Lock**

Item ID: TCW819STACK

26" PRO TOP BOX 6 DRAWERS BLACK

- Drop front with the TengTools logo to cover the drawers when the box is closed
- Each full width drawer is suitable for holding 4 TengTools TTI trays
- Supplied with an EVA drawer mat and plastic trimmed handle
- A handy lightweight plastic and aluminium tote tray is included
- Drawers have ball bearing slides for a smoother and more reliable opening and closing action
- Supplied with rubber feet to prevent it from sliding and to avoid scratching
- Use with the TengTools Get Organised system to build your ultimate tool kit

	Width mm	Depth mm	Height mm	Capacity kg
Overall	660	305	375	
Drawer 1	170	275	50	8
Drawer 2	170	275	50	8
Drawer 3	170	275	50	8
Drawer 4	569	275	50	30
Drawer 5	569	275	50	30
Drawer 6	569	275	75	30

Drawer thickness mm	0.7
Body frame thickness mm	
	0.8
Weight kg	23.4

- 6** Drawer
- 26"** Wide Box
- Heavy Gauge Steel**
- 5-Step Rust Protection**
- 3 Step Ball Bearing Slides**
- Comfort Grip Handle**
- Combination Lock**



ITEM ID:	Description
TC806NBK	Black Tool Kit with TengTools Logo sticker
TC806NGM	Black Tool Kit with a custom tool box sticker



- 6 Drawer**
- 26" Wide Box**
- Heavy Gauge Steel**
- 5-Step Rust Protection**
- 3 Step Ball Bearing Slides**
- Key Lock**

Item ID: TC806SV

26" STD TOP BOX 6 DRAWERS RED

- Drop front with the TengTools logo to cover the drawers when the box is closed
- Each full width drawer is suitable for holding 4 TengTools TTI trays or equivalent
- Drawers have ball bearing slides for a smoother and more reliable opening and closing action
- Supplied with rubber feet to prevent it from sliding and to avoid scratching
- Use with the TengTools Get Organised system to build your ultimate tool kit

	Width mm	Depth mm	Height mm	Capacity kg	Drawer thickness mm
Overall	660	305	375		0.7
Drawer 1	170	275	50	8	Body frame thickness mm
Drawer 2	170	275	50	8	
Drawer 3	170	275	50	8	0.8
Drawer 4	569	275	50	30	Weight kg
Drawer 5	569	275	50	30	
Drawer 6	569	275	75	30	23.4

26" STD FULL DEPTH TOP BOX 5 DRAWERS RED

- 5 full width drawers
- Drop front with the TengTools logo to cover the drawers when the box is closed
- Each drawer is suitable for holding 4 TengTools TTI trays plus a TTX4 tray
- Drawers have ball bearing slides for a smoother and more reliable opening and closing action
- Supplied with rubber feet to prevent it from sliding and to avoid scratching
- Use with the TengTools Get Organised system to build your ultimate tool kit

	Width mm	Depth mm	Height mm	Capacity kg	Drawer thickness mm
Overall	660	455	483		1
Drawer 1	575	380	50	30	Body frame thickness mm
Drawer 2	575	380	50	30	
Drawer 3	575	380	75	30	1
Drawer 4	575	380	75	30	Weight kg
Drawer 5	575	380	75	30	
Drawer 5	575	380	75	30	44

- 5 Drawer**
- 26" Wide Box**
- Heavy Gauge Steel**
- 5-Step Rust Protection**
- 3 Step Ball Bearing Slides**
- Key Lock**

Item ID: TC805SV



- 5 Drawer**
- 26" Wide Box**
- Heavy Gauge Steel**
- 5-Step Rust Protection**
- 3 Step Ball Bearing Slides**
- Comfort Grip Handle**
- Combination Lock**

Item ID: TC805NFX

26" PRO FULL DEPTH TOP BOX 5 DRAWERS RED

- 5 full width drawers
- Drop front with the TengTools logo to cover the drawers when the box is closed
- Each drawer is suitable for holding 4 TengTools TTI trays plus a TTX4 tray
- A handy lightweight plastic and aluminium tote tray is included
- Drawers have ball bearing slides for a smoother and more reliable opening and closing action
- Supplied with rubber feet to prevent it from sliding and to avoid scratching
- Use with the TengTools Get Organised system to build your ultimate tool kit

	Width mm	Depth mm	Height mm	Capacity kg	Drawer thickness mm
Overall	660	455	483		1
Drawer 1	575	380	50	30	Body frame thickness mm
Drawer 2	575	380	50	30	
Drawer 3	575	380	75	30	1
Drawer 4	575	380	75	30	Weight kg
Drawer 5	575	380	75	30	
Drawer 5	575	380	75	30	44

37" PRO TOP BOX 5 DRAWERS RED

- Each drawer is suitable for holding 6 TengTools TTI trays together with a TTX4 trays and a TTX2 tray
- Supplied with EVA drawer mats and plastic trimmed handles
- Drawers have ball bearing slides for a smoother and more reliable opening and closing action
- Use with the TengTools Get Organised system to build your ultimate tool kit

	Width mm	Depth mm	Height mm	Capacity kg	Drawer thickness mm
Overall	943	455	483		1
Drawer 1	860	380	50	25	Body frame thickness mm
Drawer 2	860	380	50	25	
Drawer 3	860	380	50	25	1.2
Drawer 4	860	380	75	25	Weight kg
Drawer 5	860	380	75	25	
Drawer 5	860	380	75	25	56.7

- 5 Drawer**
- 37" Wide Box**
- Heavy Gauge Steel**
- 5-Step Rust Protection**
- 3 Step Ball Bearing Slides**
- Comfort Grip Handle**
- Combination Lock**

Item ID: TC205NF





- 10 Drawer
- 53" Wide Box
- Heavy Gauge Steel
- 5-Step Rust Protection
- 3 Step Ball Bearing Slides
- Comfort Grip Handle
- Combination Lock

Item ID: TC810N

53" PRO TOP BOX 10 DRAWERS RED

- Each drawer is suitable for holding 4 TengTools TTI trays plus a TTX4 tray
- Supplied with an EVA drawer mat and plastic trimmed handle
- Drawers have ball bearing slides for a smoother and more reliable opening and closing action
- Supplied with rubber feet to prevent it from sliding and to avoid scratching
- Use with the TengTools Get Organised system to build your ultimate tool kit

	Width mm	Depth mm	Height mm	Capacity kg	Drawer thickness mm
Overall	1337	455	560		0.7
Drawer 1	575	380	75	30	Body frame thickness mm 0.8
Drawer 2	575	380	75	30	
Drawer 3	575	380	75	30	Weight kg 90
Drawer 4	575	380	75	30	
Drawer 5	575	380	75	30	
Drawer 6	575	380	75	30	
Drawer 7	575	380	75	30	
Drawer 8	575	380	75	30	
Drawer 9	575	380	75	30	
Drawer 10	575	380	75	30	

26" PRO MIDDLE BOX 3 DRAWERS RED

- Each full width drawer is suitable for holding 4 TengTools TTI trays
- Supplied with an EVA drawer mat and plastic trimmed handle
- Drawers have ball bearing slides for a smoother and more reliable opening and closing action
- Supplied with rubber feet to prevent it from sliding and to avoid scratching
- Use with the TengTools Get Organised system to build your ultimate tool kit

	Width mm	Depth mm	Height mm	Capacity kg	Drawer thickness mm
Overall	660	305	250		0.7
Drawer 1	569	275	50	30	Body frame thickness mm 0.8
Drawer 2	569	275	50	30	
Drawer 3	569	275	75	30	Weight kg 13

- 3 Drawer
- 26" Wide Box
- Heavy Gauge Steel
- 5-Step Rust Protection
- 3 Step Ball Bearing Slides
- Comfort Grip Handle
- Combination Lock

Item ID: TC803N



26" PRO MIDDLE BOX 3 DRAWERS BLACK

- Each full width drawer is suitable for holding 4 TengTools TTI trays
- Supplied with an EVA drawer mat and plastic trimmed handle
- Drawers have ball bearing slides for a smoother and more reliable opening and closing action
- Supplied with rubber feet to prevent it from sliding and to avoid scratching
- Use with the TengTools Get Organised system to build your ultimate tool kit

	Width mm	Depth mm	Height mm	Capacity kg	Drawer thickness mm
Overall	660	305	250		0.7
Drawer 1	569	275	50	30	Body frame thickness mm 0.8
Drawer 2	569	275	50	30	
Drawer 3	569	275	75	30	Weight kg 13

- 26" Wide Box
- Heavy Gauge Steel
- 5-Step Rust Protection
- 3 Step Ball Bearing Slides
- Comfort Grip Handle
- Combination Lock

Item ID: TC803NBK



26" STD MIDDLE BOX 3 DRAWERS RED

- Each full width drawer is suitable for holding 4 TengTools TTI trays
- Drawers have ball bearing slides for a smoother and more reliable opening and closing action
- Supplied with rubber feet to prevent it from sliding and to avoid scratching
- Use with the TengTools Get Organised system to build your ultimate tool kit

	Width mm	Depth mm	Height mm	Capacity kg	Drawer thickness mm
Overall	660	305	250		0.7
Drawer 1	569	275	50	30	Body frame thickness mm 0.8
Drawer 2	569	275	50	30	
Drawer 3	569	275	75	30	Weight kg 13

- 3 Drawer
- 26" Wide Box
- Heavy Gauge Steel
- 5-Step Rust Protection
- 3 Step Ball Bearing Slides
- Key Lock

Item ID: TC803SV





26" PRO LOW HEIGHT CABINET 3 DRAWERS RED

- Two 75mm deep drawers and one 150mm deep for storing larger items
- Storage compartment in the base fitted with a TengTools combination lock for secure storage of larger items
- Low height making it ideal for use beneath a low workbench
- Each drawer is suitable for holding 4 TengTools TTI trays plus a TTX4 tray
- Supplied with an ABS top mat and EVA drawer mats in each drawer
- Drawers have ball bearing slides for a smoother and more reliable opening and closing action
- Use with the TengTools Get Organised system to build your ultimate tool kit

- 3 Drawer
- 26" Wide Cabinet
- Heavy Gauge Steel
- 5-Step Rust Protection
- 5" Castor Wheels with Brakes
- 3 Step Ball Bearing Slides
- Comfort Grip Handle
- Combination Lock

	Width mm	Depth mm	Height mm	Capacity kg	Drawer thickness mm
Cabinet	670	460	656		1
Cabinet + Wheels	670	460	770		Body frame thickness mm
Drawer 1	575	380	75	30	1.2 / 1.0
Drawer 2	575	380	75	30	Weight kg
Drawer 3	575	380	150	30	44
Base Storage	610	420	250		

Item ID: TCW803N



26" PRO LOW HEIGHT CABINET 6 DRAWERS RED

- Five 75mm deep drawers and one 150mm deep drawer for storing large items
- Low height making it ideal for use beneath a low workbench
- Each drawer is suitable for holding 4 TengTools TTI trays plus a TTX4 tray
- Supplied with an ABS top mat and EVA drawer mats in each drawer
- Drawers have ball bearing slides for a smoother and more reliable opening and closing action
- Use with the TengTools Get Organised system to build your ultimate tool kit

- 6 Drawer
- 26" Wide Cabinet
- Heavy Gauge Steel
- 5-Step Rust Protection
- 5" Castor Wheels with Brakes
- 3 Step Ball Bearing Slides
- Comfort Grip Handle
- Combination Lock

	Width mm	Depth mm	Height mm	Capacity kg	Drawer thickness mm
Cabinet	670	460	656		1
Cabinet + Wheels	670	460	770		Body frame thickness mm
Drawer 1	575	380	75	30	1.2 / 1.0
Drawer 2	575	380	75	30	Weight kg
Drawer 3	575	380	75	30	54
Drawer 4	575	380	75	30	
Drawer 5	575	380	75	30	
Drawer 6	575	380	150	30	

Item ID: TCW806N



26" PRO LOW HEIGHT CABINET 4 DRAWERS RED

- Three 75mm deep drawers and one 300mm deep drawer for storing large items
- Low height making it ideal for use beneath a low workbench
- Each drawer is suitable for holding 4 TengTools TTI trays plus a TTX4 tray
- Supplied with an ABS top mat and EVA drawer mats in each drawer
- Drawers have ball bearing slides for a smoother and more reliable opening and closing action
- Use with the TengTools Get Organised system to build your ultimate tool kit

- 4 Drawer
- 26" Wide Cabinet
- Heavy Gauge Steel
- 5-Step Rust Protection
- 5" Castor Wheels with Brakes
- 3 Step Ball Bearing Slides
- Comfort Grip Handle
- Combination Lock

	Width mm	Depth mm	Height mm	Capacity kg	Drawer thickness mm
Cabinet	670	460	656		1
Cabinet + Wheels	670	460	770		Body frame thickness mm
Drawer 1	575	380	75	30	1.2 / 1.0
Drawer 2	575	380	75	30	Weight kg
Drawer 3	575	380	75	30	49
Drawer 4	575	380	300	30	

Item ID: TCW804N



26" PRO CABINET 6 DRAWERS RED

- Five 75mm deep drawers and one 300mm deep drawer for storing large items
- Each drawer is suitable for holding 4 TengTools TTI trays plus a TTX4 tray
- Supplied with an ABS top mat and EVA drawer mats in each drawer
- Drawers have ball bearing slides for a smoother and more reliable opening and closing action
- Use with the TengTools Get Organised system to build your ultimate tool kit

- 6 Drawer
- 26" Wide Cabinet
- Heavy Gauge Steel
- 5-Step Rust Protection
- 5" Castor Wheels with Brakes
- 3 Step Ball Bearing Slides
- Comfort Grip Handle
- Combination Lock

	Width mm	Depth mm	Height mm	Capacity kg	Drawer thickness mm
Cabinet	670	460	813		1
Cabinet + Wheels	670	460	960		Body frame thickness mm
Drawer 1	575	380	75	30	1.2 / 1.0
Drawer 2	575	380	75	30	Weight kg
Drawer 3	575	380	75	30	59.6
Drawer 4	575	380	75	30	
Drawer 5	575	380	75	30	
Drawer 6	575	380	300	30	

Item ID: TCW806N1



26" PRO CABINET 7 DRAWERS RED

- Five 75mm deep drawers and two 150mm deep drawers for storing large items
- Each drawer is suitable for holding 4 TengTools TT1 trays plus a TTX4 tray
- Supplied with an ABS top mat and EVA drawer mats in each drawer
- Drawers have ball bearing slides for a smoother and more reliable opening and closing action
- Use with the TengTools Get Organised system to build your ultimate tool kit

	Width mm	Depth mm	Height mm	Capacity kg	Drawer thickness mm
Cabinet	670	460	813		1
Cabinet + Wheels	670	460	960		Body frame thickness mm
Drawer 1	575	380	75	30	1.2 / 1.0
Drawer 2	575	380	75	30	Weight kg
Drawer 3	575	380	75	30	64
Drawer 4	575	380	75	30	
Drawer 5	575	380	75	30	
Drawer 6	575	380	150	30	
Drawer 7	575	380	150	30	

- 7 Drawer
- 26" Wide Cabinet
- Heavy Gauge Steel
- 5-Step Rust Protection
- 5" Castor Wheels with Brakes
- 3 Step Ball Bearing Slides
- Comfort Grip Handle
- Combination Lock

Item ID: TCW807N

26" PRO CABINET 8 DRAWERS RED

- Seven 75mm deep drawers and one 150mm deep drawer for storing large items
- Each drawer is suitable for holding 4 TengTools TT1 trays plus a TTX4 tray
- Supplied with an ABS top mat and EVA drawer mats in each drawer
- Drawers have ball bearing slides for a smoother and more reliable opening and closing action
- Use with the TengTools Get Organised system to build your ultimate tool kit

	Width mm	Depth mm	Height mm	Capacity kg	Drawer thickness mm
Cabinet	670	460	813		1
Cabinet + Wheels	670	460	960		Body frame thickness mm
Drawer 1	575	380	75	30	1.2 / 1.0
Drawer 2	575	380	75	30	Weight kg
Drawer 3	575	380	75	30	61
Drawer 4	575	380	75	30	
Drawer 5	575	380	75	30	
Drawer 6	575	380	75	30	
Drawer 7	575	380	75	30	
Drawer 8	575	380	150	30	

- 8 Drawer
- 26" Wide Cabinet
- Heavy Gauge Steel
- 5-Step Rust Protection
- 5" Castor Wheels with Brakes
- 3 Step Ball Bearing Slides
- Comfort Grip Handle
- Combination Lock

Item ID: TCW808N



26" STD CABINET 7 DRAWERS RED

- Five 75mm deep drawers and two 150mm deep for storing larger items
- Each drawer is suitable for holding 4 TengTools TT1 trays plus a TTX4 tray
- Drawers have ball bearing slides for a smoother and more reliable opening and closing action
- Use with the TengTools Get Organised system to build your ultimate tool kit

	Width mm	Depth mm	Height mm	Capacity kg	Drawer thickness mm
Cabinet	670	460	813		1
Cabinet + Wheels	670	460	960		Body frame thickness mm
Drawer 1	575	380	75	30	1.2 / 1.0
Drawer 2	575	380	75	30	Weight kg
Drawer 3	575	380	75	30	64
Drawer 4	575	380	75	30	
Drawer 5	575	380	75	30	
Drawer 6	575	380	150	30	
Drawer 7	575	380	150	30	

- 7 Drawer
- 26" Wide Cabinet
- Heavy Gauge Steel
- 5-Step Rust Protection
- 5" Castor Wheels with Brakes
- 3 Step Ball Bearing Slides
- Key Lock

Item ID: TCW707EV

26" PRO CABINET 10 DRAWERS RED

- Six 50mm deep drawers, three 75mm deep drawers and one 150mm deep drawer for storing large items
- Each drawer is suitable for holding 4 TengTools TT1 trays plus a TTX4 tray
- Supplied with an ABS top mat and EVA drawer mats in each drawer
- Drawers have ball bearing slides for a smoother and more reliable opening and closing action
- Use with the TengTools Get Organised system to build your ultimate tool kit

	Width mm	Depth mm	Height mm	Capacity kg	Drawer thickness mm
Cabinet	670	460	813		1
Cabinet + Wheels	670	460	960		Body frame thickness mm
Drawer 1	575	380	50	30	1.2 / 1.0
Drawer 2	575	380	50	30	Weight kg
Drawer 3	575	380	50	30	69
Drawer 4	575	380	50	30	
Drawer 5	575	380	50	30	
Drawer 6	575	380	50	30	
Drawer 7	575	380	75	30	
Drawer 8	575	380	75	30	
Drawer 9	575	380	75	30	
Drawer 10	575	380	150	30	

- 10 Drawer
- 26" Wide Cabinet
- Heavy Gauge Steel
- 5-Step Rust Protection
- 5" Castor Wheels with Brakes
- 3 Step Ball Bearing Slides
- Comfort Grip Handle
- Combination Lock

Item ID: TCW810N



- 10 Drawer
- 26" Wide Cabinet
- Heavy Gauge Steel
- 5-Step Rust Protection
- 5" Castor Wheels with Brakes
- 3 Step Ball Bearing Slides
- Comfort Grip Handle
- Combination Lock

Item ID: TCW810NBK

26" PRO CABINET 10 DRAWERS BLACK

- Six 50mm deep drawers, three 75mm deep drawers and one 150mm deep drawer for storing large items
- Each drawer is suitable for holding 4 TengTools TTI trays plus a TTX4 tray
- Supplied with an ABS top mat and EVA drawer mats in each drawer
- Drawers have ball bearing slides for a smoother and more reliable opening and closing action
- Use with the TengTools Get Organised system to build your ultimate tool kit

	Width mm	Depth mm	Height mm	Capacity kg	Drawer thickness mm
Cabinet	670	460	813		1
Cabinet + Wheels	670	460	960		Body frame thickness mm
Drawer 1	575	380	50	30	1.2 / 1.0
Drawer 2	575	380	50	30	Weight kg
Drawer 3	575	380	50	30	69
Drawer 4	575	380	50	30	
Drawer 5	575	380	50	30	
Drawer 6	575	380	50	30	
Drawer 7	575	380	75	30	
Drawer 8	575	380	75	30	
Drawer 9	575	380	75	30	
Drawer 10	575	380	150	30	

37" PRO CABINET 7 DRAWERS RED

- Five 75mm deep drawers and two 150mm deep for storing larger items
- Each drawer is suitable for holding 6 TengTools TTI trays together with 2 TTX4 trays and a TTX2 tray
- Supplied with a rubber top mat, EVA drawer mats and plastic trimmed handles
- Drawers have ball bearing slides for a smoother and more reliable opening and closing action
- Use with the TengTools Get Organised system to build your ultimate tool kit

	Width mm	Depth mm	Height mm	Capacity kg	Drawer thickness mm
Cabinet	953	460	813		1
Cabinet + Wheels	953	460	960		Body frame thickness mm
Drawer 1	860	380	75	25	1.0
Drawer 2	860	380	75	25	Weight kg
Drawer 3	860	380	75	25	78.6
Drawer 4	860	380	75	25	
Drawer 5	860	380	75	25	
Drawer 6	860	380	150	25	
Drawer 7	860	380	150	25	



- 7 Drawer
- 37" Wide Cabinet
- Heavy Gauge Steel
- 5-Step Rust Protection
- 5" Castor Wheels with Brakes
- 3 Step Ball Bearing Slides
- Comfort Grip Handle
- Combination Lock

Item ID: TCW207N



- 7 Drawer
- 26" Wide Cabinet
- Heavy Gauge Steel
- 5-Step Rust Protection
- 5" Castor Wheels with Brakes
- 3 Step Ball Bearing Slides
- Comfort Grip Handle
- Combination Lock
- Soft Close Drawers

Item ID: TCW907X

26" PRO CABINET 7 SOFT CLOSE DRAWERS RED

- 7 full width soft close drawers
- Each drawer has an individual opening mechanism secured with a combination lock
- Five 75mm deep drawers and two 150mm deep drawers for storing large items
- Each drawer is suitable for holding 4 TengTools TTI trays plus a TTX4 tray
- Supplied with an ABS top mat and EVA drawer mats in each drawer
- Drawers have ball bearing slides for a smoother and more reliable opening and closing action
- Use with the TengTools Get Organised system to build your ultimate tool kit

	Width mm	Depth mm	Height mm	Capacity kg	Drawer thickness mm
Cabinet	670	460	813		1
Cabinet + Wheels	670	460	960		Body frame thickness mm
Drawer 1	575	380	75	30	1.2 / 1.0
Drawer 2	575	380	75	30	Weight kg
Drawer 3	575	380	75	30	64
Drawer 4	575	380	75	30	
Drawer 5	575	380	75	30	
Drawer 6	575	380	150	30	
Drawer 7	575	380	150	30	

37" PRO CABINET 8 DRAWERS BLACK

- Seven 75mm deep drawers and one 150mm deep for storing larger items
- Each drawer is suitable for holding 6 TengTools TTI trays together with 1 TTX4 tray and a TTX2 tray
- Supplied with a rubber top mat, EVA drawer mats and plastic trimmed handles
- Drawers have ball bearing slides for a smoother and more reliable opening and closing action
- Use with the TengTools Get Organised system to build your ultimate tool kit

	Width mm	Depth mm	Height mm	Capacity kg	Drawer thickness mm
Cabinet	953	460	813		1
Cabinet + Wheels	953	460	960		Body frame thickness mm
Drawer 1	860	380	75	25	1.0
Drawer 2	860	380	75	25	Weight kg
Drawer 3	860	380	75	25	81.3
Drawer 4	860	380	75	25	
Drawer 5	860	380	75	25	
Drawer 6	860	380	75	25	
Drawer 7	860	380	75	25	
Drawer 8	860	380	150	25	

NEW



- 8 Drawer
- 37" Wide Cabinet
- Heavy Gauge Steel
- 5-Step Rust Protection
- 5" Castor Wheels with Brakes
- 3 Step Ball Bearing Slides
- Comfort Grip Handle
- Combination Lock

Item ID: TCW208NBK1



- 6 Drawer
- 3 Step Ball Bearing Slides
- 53" Wide Cabinet
- Comfort Grip Handle
- Heavy Gauge Steel
- Combination Lock
- 5-Step Rust Protection
- Single Drawer Opening
- 6" Castor Wheels with Brakes

Item ID: TCW806LN

53" PRO CABINET 6 DRAWERS RED

- Three 65mm deep drawers, one 100mm deep and two 150mm deep drawers for storing large items
- Each drawer is suitable for holding 8 TengTools TT1 trays plus 2 TTX4 trays
- Supplied with an EVA mat in each drawer
- Drawers have ball bearing slides for a smoother and more reliable opening and closing action
- Supplied with a wooden top plate to create a hard wearing work surface
- Use with the TengTools Get Organised system to build your ultimate tool kit

	Width mm	Depth mm	Height mm	Capacity kg	Drawer thickness mm
Cabinet	1350	460	767		1
Cabinet + Wheels	1350	460	937		Body frame thickness mm
Drawer 1	1215	380	65	40	1.2
Drawer 2	1215	380	65	40	Weight kg
Drawer 3	1215	380	65	40	144.5
Drawer 4	1215	380	100	40	
Drawer 5	1215	380	150	40	
Drawer 6	1215	380	150	40	

53" PRO CABINET 9 DRAWERS RED

- Six 75mm deep drawers, two 150mm deep and one 125mm deep full width drawer for storing large items
- Each regular width drawer is suitable for holding 4 TengTools TT1 trays plus a TTX4 tray
- The full width drawer is suitable for holding 8 TengTools TT1 trays plus 2 TTX4 trays
- Supplied with an EVA mat in each drawer
- Drawers have ball bearing slides for a smoother and more reliable opening and closing action
- Supplied with a wooden top plate to create a hard wearing work surface
- Use with the TengTools Get Organised system to build your ultimate tool kit

	Width mm	Depth mm	Height mm	Capacity kg	Drawer thickness mm
Cabinet	1350	460	767		1
Cabinet + Wheels	1350	460	937		Body frame thickness mm
Drawer 1	1215	380	125	40	1.2
Drawer 2	575	380	75	30	Weight kg
Drawer 3	575	380	75	30	152.5
Drawer 4	575	380	75	30	
Drawer 5	575	380	75	30	
Drawer 6	575	380	75	30	
Drawer 7	575	380	75	30	
Drawer 8	575	380	150	30	
Drawer 9	575	380	150	30	



- 9 Drawer
- 3 Step Ball Bearing Slides
- 53" Wide Cabinet
- Comfort Grip Handle
- Heavy Gauge Steel
- Combination Lock
- 5-Step Rust Protection
- 6" Castor Wheels with Brakes

Item ID: TCW809N

67" PRO BEAST CABINET 13 DRAWERS RED

- A selection of 13 different size drawers to suit all sorts of storage
- Supplied with an EVA drawer mat for storing other tools and items
- Drawers have ball bearing slides for a smoother and more reliable opening and closing action
- An additional storage compartment fitted with a combination lock for storage of larger items
- Supplied with a wooden top plate to create a hard wearing work surface
- Use with the TengTools Get Organised system to build your ultimate tool kit

	Width mm	Depth mm	Height mm	Capacity kg	Drawer thickness mm
Cabinet	1700	460	974		1
Cabinet + Wheels	1700	460	1153		Body frame thickness mm
Drawer 1	575	380	75	30	1.2
Drawer 2	575	380	75	30	Weight kg
Drawer 3	575	380	75	30	195.8
Drawer 4	575	380	75	30	
Drawer 5	575	380	75	30	
Drawer 6	575	380	154	30	
Drawer 7	575	380	312	30	
Drawer 8	288	380	75	30	
Drawer 9	288	380	75	30	
Drawer 10	288	380	75	30	
Drawer 11	288	380	154	30	
Drawer 12	288	380	154	30	
Drawer 13	1567	380	120	40	



- 13 Drawer
- 6" Castor Wheels with Brakes
- 67" Wide Cabinet
- 3 Step Ball Bearing Slides
- Heavy Gauge Steel
- Comfort Grip Handle
- 5-Step Rust Protection
- Combination Lock

Item ID: TCW814N



SIDE CUPBOARD RED

- Designed to fit on the side of a TengTools cabinet to create additional storage
- Fully lockable with a key lock
- Fitted shelf included making it ideal for storing aerosols and bulkier items
- 400(W)x200(D)x500(H) mm



- Heavy Gauge Steel**
- 5-Step Rust Protection**
- Key Lock**

Item ID: **TCW-CAB**

PRO SIDE CABINET 1 DRAWER RED

- Designed to fit on the side of a TengTools cabinet to create additional storage
- Fully lockable with a combination lock
- When mounting to a cabinet with a back panel fitted a side plate (Item ID: TCW-SP01) must be used to install
- 382(W)x460(D)x795(H) mm



- Heavy Gauge Steel**
- 5-Step Rust Protection**
- Combination Lock**

Item ID: **TCW-CAB02**

PRO SIDE CABINET 7 DRAWERS RED

- Designed to fit on the side of a TengTools cabinet to create additional storage
- Fully lockable with a combination lock
- Five 75mm deep drawers and two 150mm deep drawers for storing large items
- When mounting to a cabinet with a back panel fitted a side plate (Item ID: TCW-SP01) must be used to install



- 7 Drawer**
- Heavy Gauge Steel**
- 5-Step Rust Protection**
- 3 Step Ball Bearing Slides**
- Combination Lock**

	Width mm	Depth mm	Height mm	Capacity kg
Overall	382	460	795	
Drawer 1	288	380	75	30
Drawer 2	288	380	75	30
Drawer 3	288	380	75	30
Drawer 4	288	380	75	30
Drawer 5	288	380	75	30
Drawer 6	288	380	150	30
Drawer 7	288	380	150	30

Item ID: **TCW-CAB01**

PRO SIDE CABINET WITH DOOR RED

- Designed to fit on the side of a TengTools cabinet to create additional storage
- Fully lockable with a combination lock
- When mounting to a cabinet with a back panel fitted a side plate (Item ID: TCW-SP01) must be used to install
- 382(W)x460(D)x795(H) mm



- Heavy Gauge Steel**
- 5-Step Rust Protection**
- Combination Lock**

Item ID: **TCW-CAB03**



*Tools not included

TC3 CARRYING CASE

- An empty carrying case for use with 3 TengTools TTI tool trays
- The ideal way to create an individual, fully portable tool set
- Click lock and integral carrying handle
- The underside of the case is fitted with rubber feet to stop it sliding

Item ID: **TC-3**



*Tools not included

TC4 CARRYING CASE

- An empty carrying case for use with 4 TengTools TTI tool trays
- The ideal way to create an individual, fully portable tool set
- Click lock and integral carrying handle
- Supplied with shoulder straps to use as a back pack
- The underside of the case is fitted with rubber feet to stop it sliding

ITEM ID:	Description
TC-4	Portable carrying case
TC-4SBL	Spare straps

MECCA PRO™



MECCA PRO TC9 SERVICE CASE

- Space for up to 9 TengTools TTI trays
- Hard wearing flight case style carrying case with a combination lock and secure catches
- Robust moulded body with built in strength and durability
- Complete with fixed castor wheels and retractable handle for easy carrying
- Handles on the end and side make it easy to carry
- Non slip rubber feet to prevent the case from sliding about
- Combination lock and snap tight catches keep the tools secure
- Designed to hold 3 TengTools TTI trays in each of three compartments

Item ID: **TC-SC**

NEW

MECCA PRO™



MECCA PRO TC6 SERVICE CASE

- Service case for use with up to 6 TengTools TTI trays.
- Hard wearing carrying case with distinctive branding.
- Robust moulded body with built in strength and durability.
- Handle on side make it easy to carry.

Item ID: **TC-6T**



MINI TOP BOX

- Drop front with the TengTools logo to cover the drawers when the box is closed
- Drawers have ball bearing slides for a smoother and more reliable opening and closing action
- The underside of the box is fitted with rubber feet to prevent it from sliding
- Manufactured from heavy gauge top quality steel for rigidity and durability
- Powder coated with a 5 step rust prevention and undercoat to help prevent corrosion

	Width mm	Depth mm	Height mm	Capacity Kg	Weight kg
Overall	275	150	150		2.9
Drawer 1	215	130	38	5	
Drawer 2	215	130	38	5	

Item ID: **TC103NF**



PLASTIC TOOL BOX

- Plastic carrying case, ideal for carrying and storing tools
- Includes a tray with dividers for storing smaller items
- Double snap lock mechanism for a secure fit when closing the box

Item ID: **TCP445C**



CANTILEVER TOOL BOX

- A professional quality box with 5 individual storage areas
- Carrying handle designed to fold to the sides to enable easy access to the tools
- Padlock facility and full length piano hinges with turned edges for added safety

ITEM ID:	Description
TC540	Cantilever Tool Box
TC-540W	4x wheels for the cantilever tool box



BARN STYLE TOOL BOX

- Complete with aluminium clip rails for storing sockets
- 30 each of 1/4", 3/8" and 1/2" drive socket clips included
- A lift out tool tray and tool storage areas provide extra space
- Carrying handle designed to fold to one side to enable easy access
- Padlock facility and full length piano hinges with turned edges for added safety

Item ID: **TC450**



BACK PACK TOOL BOX

- Specifically designed for carrying tools
- Use the shoulder straps as a back pack or the carrying handles as a carrying bag
- Manufactured in polyester with EVA plastic base for durability
- Includes various external pockets for small tools

Item ID: **TCSB**



TOOL BAG

- Specifically designed for carrying tools
- Compartment that holds up to 3 TengTools TTI trays
- Use the shoulder strap or the robust aluminium carrying handle with an ergonomic grip
- Includes various pockets and holders for storing tools

Item ID: **TCSB16**



TOP BOX COVER RED

- Protective cover with the TengTools logo
- Fits TengTools 26" top boxes

Item ID: **TC-COVER**



CABINET COVER RED

- Protective cover with the TengTools logo
- Fits TengTools 26" roller cabinets

Item ID: **TC-WC02**



STACK COVER RED

- Protective cover with the TengTools logo
- Fits TengTools 26" stacks

Item ID: **TC-COVER1**



NON SLIP MAT ROLL

- Rubber mat for placing in tool boxes or tool box drawers
- 2mm thick to protect the tool box paint work
- Can also be used on work surface areas such as cabinet tops and work tops
- Resistant to oil and grease making it ideal for most workshops
- Simply cut to the required shape and size
- Supplied as a 2 meter x 45cm roll

Item ID: **TC-MAT**



ABS TOP FOR 26" CABINET

- ABS tray designed to fit the top of TengTools standard width (26"/660mm) cabinets
- Individual parts areas plus positioning for a middle box or top box to give a very organised work area
- Protects the top of the roller cabinet from scratches and marks

Item ID: **ABS-TOP**



TOTE TRAY

- Plastic tray with an aluminium handle for lighter weight
- Fitted with rubber feet on the base for less risk of scratching
- Rubber mat included to stop tools sliding around when being carried
- Helps keep tools and components close to hand and organised

Item ID: **TCA05**



MIDDLE BOX FIXING BRACKETS

- Designed to secure a TengTools middle box to a TengTools cabinet
- Simply bolts to the middle box and clips on to the roller cabinet lip
- Prevents the middle box from tipping when moving the stack system

Item ID: **TCF01**



TOP BOX FIXING BRACKETS

- Designed to secure a TengTools top box to a TengTools cabinet
- Simply bolts to the top box and clips on to the roller cabinet lip
- Prevents the top box from tipping when moving the stack system

ITEM ID:	Suitable for	No. of Pieces
TCF02	26" wide top box	2
TCF04	37" wide top box	2
TCF03	53" wide top box	2



DIVIDER SET SMALL

- Interlocking black metal dividers for use in top box size drawers
- A simple way to create a drawer with 9 separate compartments

Item ID: **TCDIVS**



DIVIDER SET LARGE

- Interlocking black metal dividers for use in roller cabinet size drawers
- A simple way to create a drawer with 9 separate compartments

Item ID: **TCDIVL**

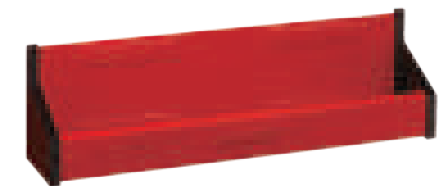

MAGNETIC TRAY RED

- Creates extra storage quickly and easily with no drilling required
- Can be easily fitted to any flat ferrous material surface
- Powerful magnets for secure fixing
- Ideal for using on the side of a tool cabinet

ITEM ID:	Width mm	Depth mm	Height mm	No. of magnets	Weight g
580K	230	98	136	2	625
580M	460	98	136	4	1164
580N	640	98	136	6	1707



MAGNETIC TRAY FOR CANS RED

- Magnetic side shelf for storing bottles and cans
- Creates extra storage quickly and easily with no drilling required
- Can be easily fitted to any flat ferrous material surface
- Powerful magnets for secure fixing
- Ideal for using on the side of a tool cabinet

ITEM ID:	Width mm	Depth mm	Height mm	No. of Can Holders	Weight g
580CK	230	98	136	2	625
580CM	460	98	136	4	1200
580CN	640	98	136	6	1683



MAGNETIC TRAY FOR CANS RED

- Magnetic side shelf for storing bottles and cans
- Creates extra storage quickly and easily with no drilling required
- Can be easily fitted to any flat ferrous material surface
- Powerful magnets for secure fixing
- Ideal for using on the side of a tool cabinet

ITEM ID:	Width mm	Depth mm	Height mm
580C	310	115	31
580D	210	115	31



MAGNETIC SIDE SHELF RED

- Creates extra storage quickly and easily with no drilling required
- Can be easily fitted to any flat ferrous material surface
- Powerful magnets for secure fixing
- Ideal for using on the side of a roller cabinet

ITEM ID:	Width mm	Depth mm	Height mm
580J	410	90	100



*Paper roll not included

PAPER ROLL HOLDER

- Designed to fit on to the side of TengTools cabinets (fixings included)
- Fold out side tray (370 x 370mm) to create an additional working area
- Fixing bar for paper rolls up to 360mm width (paper roll not included)

Item ID: **TCA01**



SIDE SHELF FOR VICE

- Designed to fit on to the side of TengTools cabinets (fixings included)
- Side shelf has fixing holes for the TengTools 4" vice (TCAV4)

Item ID: **TCATV**



4" WORK BENCH VICE

- Forged steel 4" (100mm)
- Interchangeable parallel jaws and removable V shaped jaws for holding pipes and tubes
- High wear resistance with S45S steel (HRC45-50 hardness) for durability and strength
- Maximum clamping force of 300kg/cm² to grip most items tightly

Item ID: **TCAV4**



*Hooks not included

SIDE PANEL WITH STAND

- Designed to fit on the side of a TengTools regular height tool cabinet
- Creates an additional storage area for hanging tools or adding hook in accessories
- Supplied with a carrying handle and a fold out leg to create a free standing tool storage unit
- Dimensions: 460x640mm

Item ID: **TCW-SP**



SIDE PANEL FOR CABINET

- Designed to fit on the side of a TengTools regular height tool cabinet
- Creates an additional storage area for hanging tools or adding hook in accessories
- Dimensions: 805(H)x4560(W)x25(D)mm

Item ID: **TCW-SP01**



TOOL HOOKS

- Hooks for use with TengTools panels with square holes
- Screw fixing to fix the hook securely in place
- Ideal for hanging tools on a work station panel or a side plate on a roller cabinet

ITEM ID:	Description
TCW-HK10	7 x 90°, 3 x 45° hooks for side panel
TCW-HK02	10 x double hooks for side panel
TCW-HK03	TCW-HK90 x6, TCW-HK45 x6, TCW-HK02 x8
TCW-HK45	10 x 45° hooks for side panel
TCW-HK90	10 x 90° hooks for side panel



SOCKET CLIP RAIL SET

- Four track aluminium section together with carrying handles
- 450mm overall length to fit in most tool boxes
- Supplied with 10 each socket clips in 1/4", 3/8" and 1/2" drive

Item ID: **ALU450**



SOCKET CLIP RAILS

- Aluminium section for mounting on the wall or in a tool box
- For use with TengTools socket clips in 1/4", 3/8", 1/2", or 3/4"

ITEM ID:	Description
ALU430	430mm single track socket rail
ALU1000-1	1 metre single track socket rail
ALU1000-4	1 metre four track socket rail



SOCKET SLIPS

- Packs of 10
- For storing sockets and accessories on clip rails

ITEM ID:	Description
ALU14	10 x 1/4" drive socket clips
ALU38	10 x 3/8" drive socket clips
ALU12	10 x 1/2" drive socket clips
ALU34	10 x 3/4" drive socket clips



MAGNETIC TOOL RAIL

- 6 individual magnets each with a capacity of 450g
- Designed to fix to the side of TengTools roller cabinets
- Also suitable for wall mounting or for use with other tool boxes
- Ideal for hanging up tools while working

Item ID: **TC-MAG**



WORKTOPS FOR TOOL CABINETS

- 37mm thick worktops in hard wearing laminated wood
- Three sizes available to suit different roller cabinets

ITEM ID:	Length mm	Depth mm	Thickness mm	Suitable for
TC-TB02	672	460	37	TCW803N, TCW804N, TCW806N, TCW806N1, TCW807N, TCW808N, TCW810N, TCW-707EV, TCW907X
TC-TB03	948	460	18	TCW207N, TCW208NBK1
TC-TB01	1354	460	37	TCW806LN, TCW809N



SIDE HANDLES FOR TOP/MIDDLE BOX

- A pair of side handles with soft grip for use with TengTools top boxes and middle boxes

Item ID: **TCDSH**



SIDE HANDLE FOR CABINET

- Side handle for TengTools roller cabinets
- The soft grip handle gives improved comfort

Item ID: **TCRFH**



WHEEL SET 5" X 2"

- A set of four 5" (125mm) black castors with needle bearings
- 2" wide wheels give extra strength and stability
- Capacity of 170 kilos per castor or 500 kilos for the set of four
- Ideal for upgrading a TengTools roller cabinet for heavier use
- Two fixed and two swivel wheels with 2 stage brakes in the set

Item ID: **TCNCB**



TROLLEY FOR TOP BOX

- Frame with a set of 4 wheels for TengTools regular top boxes
- Creates a mobile tool box
- Especially useful if the tool box is heavily laden with tools

Item ID: **TCTMC**



TROLLEY FOR SIDE CABINET

- Frame with a set of 4 wheels for TengTools side cabinets
- Creates a mobile tool box or storage unit
- Especially useful if the cabinet is heavily laden

Item ID: **TCSMC**



ONE KEY THREE LOCKS

- Set of 3 key type locks for TengTools tool boxes
- One common key number
- Enables a stack system to be converted to have one common key on all locks

Item ID: **TC-LOCK3**



ONE KEY FIVE LOCKS

- Set of five key type locks for TengTools tool boxes
- One common key number
- Enables a stack system to be converted to have one common key on all locks

Item ID: **TC-LOCK5**



BLANK KEY

- Blank key for TengTools key type locks
- For creating replacement keys

Item ID: **TC-BKEY**

REPLACEMENT LOCKS

Which lock to choose?



Key Locks

ITEM ID:
TCDRK
TCPRK

Tool Box	Description	Lock
TC806SV	6 drawer top box	TCPRK
TC803SV	3 drawer middle box	TCDRK
TCW707EV	7 drawer roller cabinet	TCDRK
TCW-CAB	Side cupboard	TCPRK



Combination Locks

ITEM ID:
TC-90CLOCK
TC-180CLOCK

Tool Box	Description	Lock
TC805NFX	5 drawer top box	TC-90CLOCK
TC806NF	6 drawer top box	TC-90CLOCK
TC806NGM	6 drawer top box	TC-90CLOCK
TC803N	3 drawer middle box	TC-180CLOCK
TC803NBK	3 drawer middle box	TC-180CLOCK
TCW803N	3 drawer roller cabinet	TC-180CLOCK
TCW803N	Storage compartment	TC-90CLOCK
TCW804N	4 drawer roller cabinet	TC-180CLOCK
TCW806N	6 drawer roller cabinet	TC-180CLOCK
TCW806N1	6 drawer roller cabinet	TC-180CLOCK
TCW807N	7 drawer roller cabinet	TC-180CLOCK
TCW810N	10 drawer roller cabinet	TC-180CLOCK
TCW810NBK	10 drawer roller cabinet	TC-180CLOCK
TC810N	10 drawer double width top box	TC-90CLOCK
TCW207N	7 drawer 37" wide roller cabinet	TC-180CLOCK
TCW208NBK1	8 drawer 37" wide roller cabinet	TC-180CLOCK
TCW806LN	6 drawer double width roller cabinet	TC-180CLOCK
TCW809N	9 drawer double width roller cabinet	TC-180CLOCK
TCW-CAB01	Side cabinet	TC-180CLOCK
TCW-CAB02	Side cabinet	TC-180CLOCK
TCW-CAB03	Side cabinet	TC-90CLOCK



- Heavy Gauge Steel**
- 5-Step Rust Protection**
- 5" Castor Wheels with Brakes**
- 3 Step Ball Bearing Slides**

26" TOOL TROLLEY 1 DRAWER RED

- Mobile trolley
- A mobile work trolley with shelves and a drawer
- Two fixed castors and two swivelling castors with brakes
- Two shelves and a ball bearing slide drawer
- Ideal for moving parts and equipment around the work place

ITEM ID	Height mm	Height (Wheels) mm	Width mm	Depth mm
TR070	770	932	700	450
TR135	770	932	1339	450



WORK BENCHES

- Sturdy, laminated granite effect work surface with black edging
- Adjustable legs to give a working height of between 707 & 927mm

ITEM ID	Length mm	Depth mm	Weight kg
TWB1500	1500	800	53
TWB2000	2000	800	69



*Workbench not included

WORK BENCH TOOL PANEL KITS

- A panel kit complete with uprights and fixings for use with the TengTools workbench
- Converts a workbench into a work station
- Uses the TengTools square hole system for use with a wide range of hooks and accessories

ITEM ID	Suitable for	Width mm	No. of Panels
TWB-1500A	TWB1500	1500	2
TWB-2000A	TWB2000	2000	4

WORKBENCH SPARE PARTS

ITEM ID:	Description
TWB-15TOP	Workbench Work Top 1500mm
TWB-20TOP	Workbench Work Top 2000mm
TWB-4WD	Workbench Wheel Set
TWB-LEG	Workbench Legs 2 Pieces
TWB-PA	Workbench Panel
TWB-UPR	Workbench Upright
TWB-15SQ	Workbench Spare 9 Hole Square Tube

WORKBENCH ADD-ONS FOR CABINETS



*Tool Cabinet not included

TOOL PANEL SET FOR 26" CABINET

- Preconfigured pack including panels, uprights, fixing bars, a header and a work top
- Designed to fit on top of TengTools cabinets
- Creates a single width work station

ITEM ID	Suitable for
TC-S01	26" Tool Cabinets
TC-SL01	53" Tool Cabinets



*Tool Cabinets not included

ADD ON PANEL SET BETWEEN CABINETS

- Preconfigured pack including panels, brackets, fixing bars, a header and a work top
- Designed to fit with a TengTools cabinet when a panel set has already been installed
- Creates a double width work station

ITEM ID	Suitable for
TC-S02	26" Tool Cabinets
TC-SL02	53" Tool Cabinets



*Tool Cabinet not included

ADD ON PANEL SET BESIDE CABINET

- Preconfigured pack including panels, brackets, fixing bars, a header, a work top and a side leg
- Designed to fit with a TengTools cabinet when a panel set has already been installed
- Creates a double width work station

ITEM ID	Suitable for	Side
TC-S03AL	26" Tool Cabinets	Left Add-on
TC-SL03AL	53" Tool Cabinets	Left Add-on
TC-S03AR	26" Tool Cabinets	Right Add-on
TC-SL03AR	53" Tool Cabinets	Right Add-on



- Heavy Gauge Steel
- 5-Step Rust Protection
- Combination Lock

TOOL CABINETS WITH PEG HOLES

- Panels have square peg holes for use with the range of TengTools hooks
- Ideal for use with workbenches or on top of any standard width TengTools roller cabinet

ITEM ID	Width mm	Height mm	Depth mm	Weight kg
TCB80	660	600	305	15
TCB80A	660	600	455	16.5



- Heavy Gauge Steel
- 5-Step Rust Protection
- Combination Lock

WALL HANGING TOOL CABINET 820 mm

- Designed for wall mounting, heavy duty mounting brackets included
- Peg board included on the inner back of the cabinet and on the inner side of the doors
- Ideal for use with workbenches to create a self contained working area

ITEM ID	Width mm	Height mm	Depth mm	Weight kg
TCB80C	820	900	250	24



- Heavy Gauge Steel
- 5-Step Rust Protection
- Combination Lock

WALL HANGING TOOL CABINET 1350 mm

- Inside panel has square peg holes for use with the range of TengTools hooks
- Designed for wall mounting, heavy duty mounting brackets included
- Ideal for use with workbenches to create a self contained working area

ITEM ID	Width mm	Height mm	Depth mm	Weight kg
TCB135	1335	700	200	35.75



- Heavy Gauge Steel
- 5-Step Rust Protection
- Combination Lock

WALL HANGING TOOL CABINET 1800 mm

- Inside panel has square peg holes for use with the range of TengTools hooks
- Designed for wall mounting, heavy duty mounting brackets included
- Ideal for use with workbenches to create a self contained working area

ITEM ID	Width mm	Height mm	Depth mm	Weight kg
TCB180	1800	700	200	50

WORKSTATION SPARE PARTS

ITEM ID:	Description
TC-LBK	L Brackets 2pcs
TC-LEG	Support Leg
TC-FB01	664mm Fixing Bar
TC-FB02	1353mm Fixing Bar
TC-H01	670mm Header
TC-H02	1380mm Header
TC-PA01	Panel for 26" cabinets
TC-PA02	Panel for 53" cabinets
TC-UPRL	Left Upright Long
TC-UPRR	Right Upright Long
TC-160UR	Uprights 1.6m 2pcs
TC-FB03	916mm Fixing Bar
TC-PA03	Panel for 37" cabinets
TC-H05	950mm Header
TC-UPRLS	LHS Upright Short
TC-UPRRS	RHS Upright Short
TWB-20SQ	7 Hole Square Tube
TC-H03	1.5m Header
TC-H04	0.5m Header
TWB-FB	Fixing Bar 875mm



HOOK ON TRAY

- Parts tray for tool panels
- Designed to hook in to the square holes on panels
- Ideal for storing accessories, components, small tools, etc.

ITEM ID	Width mm	Depth mm	Height mm
TCT01	230	101	139
TCT02	460	101	140
TCT03	640	103	141



HOOK ON TRAY FOR CANS

- Aerosol can holder for tool panels
- Designed to hook in to the square holes on TengTools panels
- Ideal for storing aerosol cans, bottles, etc.

ITEM ID	Width mm	Depth mm	Height mm	No. of Can Holders
TCC01	230	98	136	2
TCC02	460	99	137	4
TCC03	640	100	138	6



TOOL HOOKS

- Hooks for use with TengTools panels with square holes
- Screw fixing to fix the hook securely in place
- Ideal for hanging tools on a work station panel or a side plate on a roller cabinet

ITEM ID:	Description
TCW-HK10	7 x 90°, 3 x 45° hooks for side panel
TCW-HK02	10 x double hooks for side panel
TCW-HK03	TCW-HK90 x6, TCW-HK45 x6, TCW-HK02 x8
TCW-HK45	10 x 45° hooks for side panel
TCW-HK90	10 x 90° hooks for side panel



*T-bar not included

HOOK ON TOOL HOLDER

- Hook tool holder for tool panels
- Designed to hook in to the square holes on TengTools wall and side panels and wall cabinets
- Ideal for storing tools such as T bars etc

Item ID: **TCT04**



MAGNETIC LED LIGHT BAR

- 255mm wide light bar with 9 built in white LED lights
- 120 light distribution angle to illuminate a wide area
- Magnetic attachment for fixing quickly and simply with no drilling required
- Requires 3 AA batteries (not included)
- Ideal for use with workbenches as a light source

Length mm	Width mm	Height mm	Light Lumen	Magnetic Pull N	Weight g
255	40	29	20	30 x2	188

Item ID: **587J**



WORK BENCH LED LIGHT

- 660mm wide light bar with 80 built in white LED lights
- 7.2 watts (2,040 lumen) to give a powerful light source
- Magnetic attachment for fixing quickly and simply with no drilling required
- Ideal for use with workbenches as a light source

ITEM ID	Region
589ME	Europe
589MU	UK
589MA	Aus / NZ

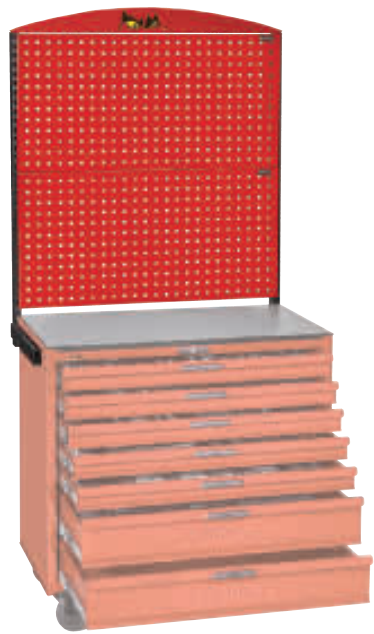

*Tool Cabinet not included

- Heavy Gauge Steel
- 5-Step Rust Protection

ADD ON PANEL SET FOR 37" CABINET

- Preconfigured pack including panels, fixing bar, a header and uprights
- Designed to fit on top of an extra wide 37" TengTools roller cabinet
- Creates an extra wide single width work station with a high level back panel

ITEM ID	Suitable for	Number of Panels
TC-S03	37" Roller Cabinet	2
TC-S04	37" Roller Cabinet	1



- Heavy Gauge Steel
- 5-Step Rust Protection

33 Pieces

PORTABLE TOOL PANEL TOOL KIT 33 PIECES

- Portable work station with tools
- A single sided portable work station (TPM01) supplied with tools
- Includes four wall rack sets covering screwdrivers, pliers, spanners and T handle hex keys
- The ideal movable tool station for use around the work place

Contents	
Item ID	Description
WRMD10N	Screwdriver Set Wall Rack 10 Pieces
WRMB04	Plier Set Wall Rack 4 Pieces
WRSP12	Combination Spanner Set 8-19 mm Wall Rack 12 Pieces
WRHEX07	T-Handle Ball Point Hex Key Set Wall Rack 7 Pieces

Item ID: **TPT01**



- Heavy Gauge Steel
- 5-Step Rust Protection

PORTABLE TOOL PANELS

- The ideal way to store tools when they need to be moved around the work place
- The unit is 1.6m tall on castors
- Tool panels can be fitted to either side
- For use with TengTools wall racks and workbench accessories

ITEM ID	Front Panels	Back Panels
TPM01	2	0
TPM02	2	2

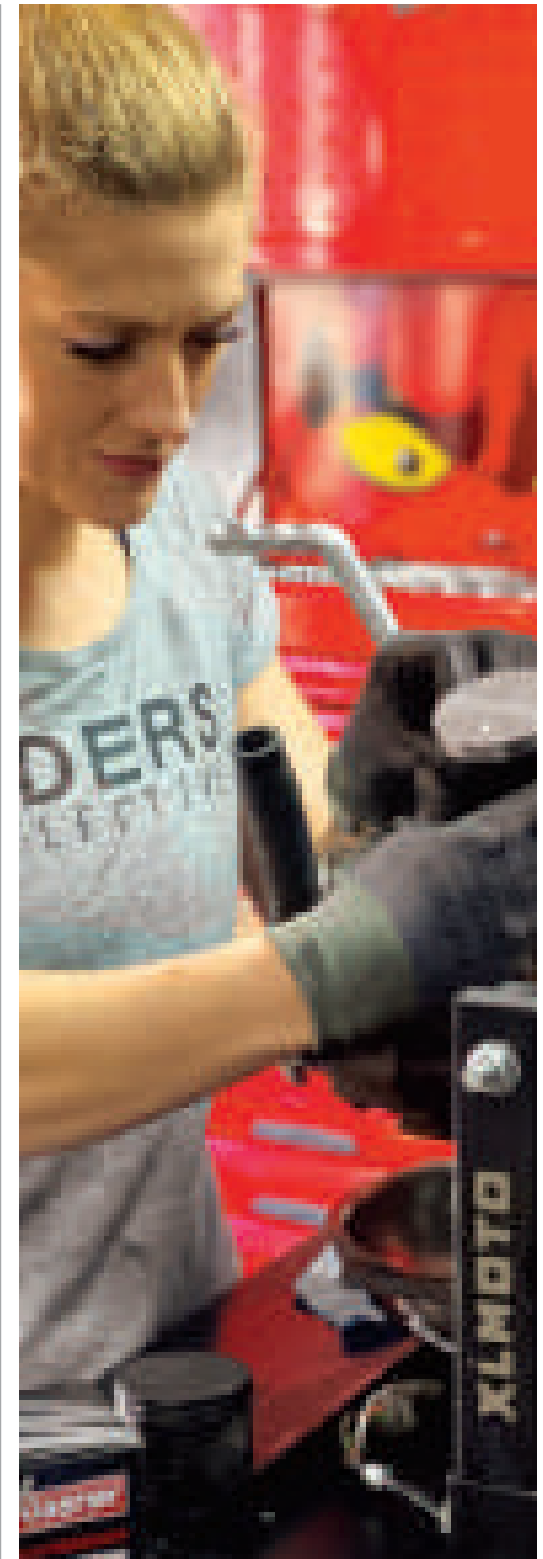

TOOL CONTROL SYSTEM

GET ORGANISED™ FOR A BETTER WORKFLOW

The TengTools Tool Control System offers more than 240 modular tool sets that fit into a wide selection of storage solutions from large cabinets and tool box combinations to small portable service cases. This makes it easy to create a bespoke tool kit that suits your exact needs.



SAVE TIME, SAVE MONEY

WHEN YOU GET ORGANISED™ WITH TENGTOOLS...

You will maximise your efficiency, increase your job satisfaction, and save money.

You will get a safer, more efficient work environment for professional tool users and their organisations alike.

You will spend more time using your tools and less time looking for them. With our modular Get Organised Tool Control System every tool has its own specific place so you know exactly where each tool is when you need it.

You get tools manufactured to, or exceed, the relevant industrial standards. In quality testing, our tools have proven to be better than other leading competitors in relation to durability, accuracy, and reliability.

Which tool kit makes it easier to get the job done?

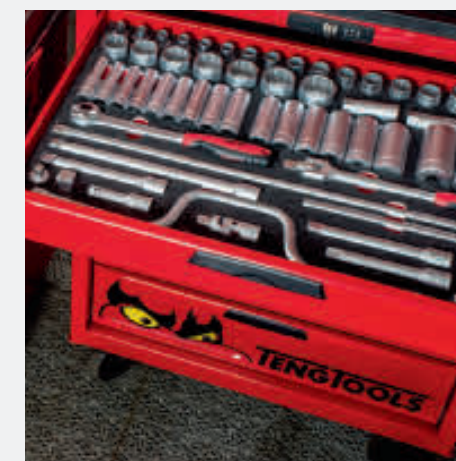

GET ORGANISED™ IN THREE EASY STEPS

1 CHOOSE YOUR STORAGE

Storages for all needs.



2 CHOOSE YOUR TOOL SETS

Your kit. Your way.



3 ORGANISE YOUR KIT

Optimise your workflow.

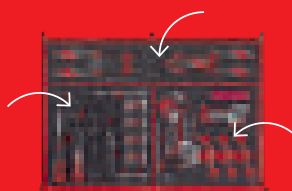

A MODULAR SYSTEM THAT FITS ALL TYPES OF STORAGE

All tool sets are available in sizes that can be combined to fit perfectly into your chosen storage solution, regardless of whether you have chosen a storage that is portable, 26, 37 or 53 inches.

Portable Service case



1

26" Top & Middle box drawer

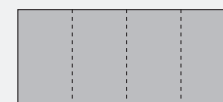

4

26" cabinet drawer

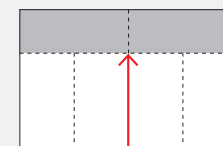

x4

37" cabinet drawer

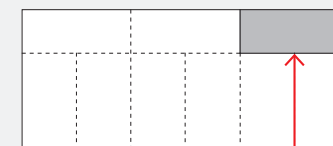

x2

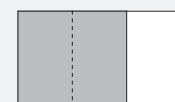

2

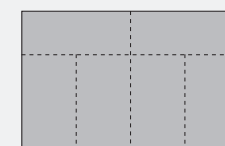

4x4

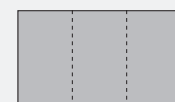

3

A FLEXIBLE TOOL CONTROL SYSTEM WITH OVER 240 TOOL SETS



TT Series

The TT Series offers a space-saving tool control system allowing you to fit more tools in each drawer. With our wide assortment you can build some of the largest tool kits in the market in just 26" wide stack. The tool trays are made of recyclable plastic and are ideal for use in high moisture areas.



Foam Series

The Foam Series offers the ultimate tool organisation. Each tool has its own place with its description imprinted in the 3-coloured foam. The contrast colours makes it easy to identify tools and see when a tool is missing. The high quality foam stays soft and flexible even in cold environments and gives the tool kit a premium look.

STORAGE TRAYS



CLIP RAIL SET TTI 32 PIECES

- Includes 2 clip rails and clips for 1/4", 3/8" and 1/2" drive sockets
- A protective mat is included in the bottom of the tray
- Removable lid and dove tail joints

2 x 260mm aluminium rails, 10 x 1/4" drive socket clips, 10 x 3/8" drive socket clips, 10 x 1/2" drive socket clips

Item ID: TTALU



STORAGE TRAY TTI WITH TOOL HOLDER

- Includes plastic clips for holding spanners or screwdrivers
- A protective mat is included in the bottom of the tray
- Removable lid and dove tail joints

Item ID: TT00



STORAGE TRAY TTI 7 COMPARTMENTS

- Storage tray with 7 compartments
- Ideal for storing small components and consumables
- Removable lid and dove tail joints

Item ID: TT01



STORAGE TRAY TTI 2 COMPARTMENTS

- Storage tray with 2 compartments
- Ideal for storing small components and consumables
- Removable lid and dove tail joints

Item ID: TT02



STORAGE TRAY TTI 4 COMPARTMENTS

- Storage tray with 4 compartments
- Ideal for storing small components and consumables
- Removable lid and dove tail joints

Item ID: TT03



STORAGE TRAY TTI 6 COMPARTMENTS

- Storage tray with 6 compartments
- Ideal for storing small components and consumables
- Removable lid and dove tail joints

Item ID: TT04



STORAGE TRAY TTI FOR TJ SETS

- Empty tray for holding 4x TJ sets
- Removable lid and dove tail joints

Item ID: TTTJ04



STORAGE TRAY TT2 4 COMPARTMENTS

- Storage tray with 4 compartments
- Ideal for storing small components and consumables
- Removable lid and dove tail joints

Item ID: TTD00



STORAGE TRAY TT2 8 COMPARTMENTS

- Storage tray with 8 compartments
- Ideal for storing small components and consumables
- Removable lid and dove tail joints

Item ID: TTD01



STORAGE TRAY TT2 16 COMPARTMENTS

- Storage tray with 16 compartments
- Ideal for storing small components and consumables
- Removable lid and dove tail joints

Item ID: TTD02



STORAGE TRAY TTX4 1 COMPARTMENT

- Storage tray with 1 compartment
- Ideal for storing additional tools, components and consumables
- Protective mat is included in the bottom of the tray

Item ID: TTX00



STORAGE TRAY TTX4 6 COMPARTMENTS

- Storage tray with 6 compartments
- Ideal for storing additional tools, components and consumables

Item ID: TTX01



TT SERIES
x4
STORAGE TRAY TTX4 4 COMPARTMENTS

- Storage tray with 4 compartments
- Ideal for storing additional tools, components and consumables

Item ID: **TTX02**



TT SERIES
x4
STORAGE TRAY TTX4 8 COMPARTMENTS

- Storage tray with 8 compartments
- Ideal for storing additional tools, components and consumables

Item ID: **TTX03**



TT SERIES
x2
STORAGE TRAY TTX2 6 COMPARTMENTS

- Storage tray with 6 compartments
- Ideal for storing small components and consumables

Item ID: **TTZ01**

GENERAL TOOL KITS



TT SERIES
4
GENERAL TOOL SET BP TT4 9 PIECES 9 Pieces

- A selection of tools to compliment any tool kit
- Includes measuring, striking and cutting tools as well as an adjustable wrench and power grip pliers

General Tools:

6" adjustable wrench, 10" adjustable wrench, 10" power grip plier, utility knife, 12" hack saw, soft face hammer, 3 meter tape measure, 200mm steel rule, 24oz (675g) ball pein hammer

Item ID: **TTPS09**



TT SERIES
4
GENERAL TOOL SET E TT4 9 PIECES 9 Pieces

- A selection of tools to compliment any tool kit
- Includes measuring, striking and cutting tools as well as an adjustable wrench and power grip pliers

General Tools:

6" adjustable wrench, 10" adjustable wrench, 10" power grip plier, utility knife, 12" hack saw, soft face hammer, 3 meter measuring tape, 200mm steel rule, 800g engineers hammer

Item ID: **TTPS09E**



TT SERIES
3
GENERAL TOOL SET BP TT3 6 PIECES 6 Pieces

- Especially designed for use in the TengTools TC-SC portable service case
- A set of general hand tools to compliment the other sets in a tool kit

General Tools:

Measuring tape, hacksaw frame, utility knife, power grip plier, adjustable wrench, ball pein hammer

Item ID: **SCPS01**



TT SERIES
3
GENERAL TOOL SET E TT3 6 PIECES 6 Pieces

- Especially designed for use in the TengTools TC-SC portable service case
- A set of general hand tools to compliment the other sets in a tool kit

General Tools:

Measuring tape, hacksaw frame, utility knife, power grip plier, adjustable wrench, engineers hammer

Item ID: **SCPS01E**

SOCKET SETS



TT SERIES
1
1/4" SOCKET SET 6 PT TTI 35 PIECES 35 Pieces 1/4" mm

1/4" SOCKET SET 6 PT TTI 35 PIECES

- Regular and deep 6 point single hexagon sockets
- Chrome vanadium satin finish sockets
- Designed and manufactured to DIN and ISO standards

72 Teeth ratchet, Universal Joint, 6" spinner handle

Coupler adaptor, 2" & 4" Extension bars, 3/8" F x 1/4" M T-bar adaptor

6 point sockets:

Reg mm:	4	5	5.5	6	7	8	9
	10	11	12	13			
Deep mm:	6	7	8	10	12	13	
1/4" Hex bits:	4, 5.5	TPX10, TPX15, TPX20	5, 6				
	PH1, PH2	PZ1, PZ2					

Item ID: **TTI435**



TT SERIES



35 Pieces 1/4" mm

1/4" SOCKET SET 12 PT TTI 35 PIECES

- Regular and deep 12 point bi-hexagon sockets
- Chrome vanadium satin finish sockets
- Designed and manufactured to DIN and ISO standards

72 Teeth ratchet, Universal Joint, 6" spinner handle

Coupler adaptor, 2" & 4" Extension bars, 3/8" F x 1/4" M T-bar adaptor

12 point sockets:

Reg mm: 4 5 5.5 6 7 8 9

10 11 12 13

Deep mm: 6 7 8 10 12 13

1/4" Hex bits: PH1, PH2, PZ1, PZ2, TPX10, TPX15, TPX20, 5, 6

Item ID: **TT143512**



TT SERIES



32 Pieces 1/4" 3/8" AF

1/4" & 3/8" SOCKET SET AF 6 PT TTI

- Regular and deep 6 point single hexagon sockets
- Chrome vanadium satin finish sockets
- Designed and manufactured to DIN3120/3124 and ISO2725

3/8" Drive 6 point sockets:

Reg AF: 3/8 7/16 1/2 9/16 5/8 11/16 3/4

Deep AF: 3/8 7/16 1/2 9/16 5/8 11/16 3/4

1/4" Drive 6 point sockets:

Reg AF: 3/16 7/32 1/4 9/32 5/16 11/32 3/8 7/16 1/2

Deep AF: 3/16 7/32 1/4 9/32 5/16 11/32 3/8 7/16 1/2

Item ID: **TTAF32**



TT SERIES



32 Pieces 1/4" 3/8" AF

1/4" & 3/8" SOCKET SET 12 PT AF TTI

- Regular and deep 12 point bi-hexagon sockets
- Chrome vanadium satin finish sockets
- Designed and manufactured to DIN3120/3124 and ISO2725

3/8" Drive 6 point sockets:

Reg AF: 3/8 7/16 1/2 9/16 5/8 11/16 3/4

Deep AF: 3/8 7/16 1/2 9/16 5/8 11/16 3/4

1/4" Drive 6 point sockets:

Reg AF: 3/16 7/32 1/4 9/32 5/16 11/32 3/8 7/16 1/2

Deep AF: 3/16 7/32 1/4 9/32 5/16 11/32 3/8 7/16 1/2

Item ID: **TTAF3212**



TT SERIES



48 Pieces 1/4" mm

1/4" SOCKET & BITS SET TTI 48 PIECES

- Gearless palm ratchet, 3" extension bar
- 1/4" drive regular 6 point sockets 5-13mm
- A selection of 25mm & 89mm long bits

Gearless palm ratchet, 3" extension bar

6 point sockets:

Reg mm: 5 5.5 6 7 8 9 10 11

11 12 13

1/4" Hex bits: Length 25mm PH1, PH2, PH3, TPX20, TPX25, TPX30, TX10, TX15, TX20, TX25, TX30, TX40, ROB1, 2, 3

1/4" Hex bits: Length 89mm TX10, TX20, TX25, PH1, PH2, PZ1, PZ2

TX10, TX20, TX25

TX10, TX20, TX25

TX10, TX20, TX25

Item ID: **TT1448**



TT SERIES



19 Pieces 3/8" mm

3/8" SOCKET SET 6 PT TTI 19 PIECES

- Regular 6 point single hexagon sockets
- Chrome vanadium satin finish sockets
- Designed and manufactured to DIN and ISO standards

72 Teeth ratchet, Universal Joint, 3" Wobble extension bar, 10" Spinner handle

Coupler adaptor, 1/2" F x 3/8" M T-bar adaptor

Regular 6 point sockets:

mm: 8 9 10 11 12 13 14 15 16

17 18 19 22

Item ID: **TT3819**



TT SERIES



19 Pieces 3/8" mm

3/8" SOCKET SET 12 PT TTI 19 PIECES

- Regular 12 point bi-hexagon sockets
- Chrome vanadium satin finish sockets
- Designed and manufactured to DIN and ISO standards

72 Teeth ratchet, Universal Joint, 3" Wobble extension bar, 10" Spinner handle

Coupler adaptor, 1/2" F x 3/8" M T-bar adaptor

Regular 12 point sockets:

mm: 8 9 10 11 12 13 14 15 16

17 18 19 22

Item ID: **TT381912**



TT SERIES



16 Pieces 3/8" mm

3/8" SOCKET SET 6 PT TTI 16 PIECES

- Deep 6 point single hexagon sockets
- Chrome vanadium satin finish sockets
- Designed and manufactured to DIN3120/3124 and ISO2725

Deep 6 point sockets:

mm: 7 8 9 10 11 12 13 14 15

16 17 18 19 20 21 22

Item ID: **TT3816**



TT SERIES



16 Pieces 3/8" mm

3/8" SOCKET SET 12 PT TTI 16 PIECES

- Deep 12 point bi-hexagon sockets
- Chrome vanadium satin finish sockets
- Designed and manufactured to DIN3120/3124 and ISO2725

Deep 12 point sockets:

mm: 7 8 9 10 11 12 13 14 15

16 17 18 19 20 21 22

Item ID: **TT381612**



TT SERIES
1

30 Pieces 1/4 3/8

3/8" TX BIT SOCKET SET TTI 30 PIECES

- Chrome vanadium satin finish sockets
- Designed and manufactured to DIN and ISO standards

3" Extension bar, 3/8" F x 1/4" M adaptor

3/8" Drive bit sockets:

	TX:	10	15	20	25	27	30	40	45	50
	TPX:	10	15	20	25	27	30	40	45	50
	TX-E:	E10	E12	E14	E16	E18				

1/4" Drive bit sockets:

	TX-E:	E4	E5	E6	E7	E8
--	-------	----	----	----	----	----

Item ID: **TTTX30**



TT SERIES
1

35 Pieces 1/4 3/8

1/4" & 3/8" BIT SOCKET SET TTI 35 PIECES

- Includes all the most commonly used screwdriver, hex and TX bits
- Chrome vanadium satin finish sockets

3/8" F x 1/4" M adaptor, 1/4" F x 3/8" M adaptor

1/4" Drive bit sockets:

	TX:	10	15	20	25	27	30	40
	mm:	4	4.5	7				
	PH:	0	1	2	3			
	PZ:	1	2	3				

3/8" Drive bit sockets:

	mm:	3	4	5	5.5	6	7	8	10	12
	AF:	1/8	5/32	3/16	7/32	1/4	5/16	3/8		

Item ID: **TTBS35**



TT SERIES
1

5 Pieces 1/2

1/2" RATCHET & ACCESSORIES SET TTI 5 PIECES

- Socket accessory set
- Designed and manufactured to DIN and ISO standards

72 Teeth ratchet, 5" & 10" Extension bars

Universal joint, 3/8" F x 1/2" M T-bar adaptor

Item ID: **TTI205**



TT SERIES
1

11 Pieces 1/2 mm

1/2" DEEP SOCKET SET 12 PT TTI 11 PIECES

- Deep 12 point bi-hexagon sockets
- Includes a 10" flex handle with ergonomic grip
- Chrome vanadium satin finish
- Designed and manufactured to DIN and ISO standards

10" Flex handle

Deep 12 point sockets:

	mm:	10	11	12	13	14	15
		16	17	18	19		

Item ID: **TTI211**



TT SERIES
1

17 Pieces 1/2 mm

1/2" SOCKET SET 6 PT TTI 17 PIECES

- 6 point single hexagon sockets
- Chrome vanadium satin finish sockets
- Designed and manufactured to DIN3120/3124 and ISO2725

Regular 6 point sockets:

	mm:	10	11	12	13	14	15	16	17	18
		19	20	21	22	24	27	30	32	

Item ID: **TTI217-6**



TT SERIES
1

17 Pieces 1/2 mm

1/2" SOCKET SET 12 PT TTI 17 PIECES

- 12 point bi-hexagon sockets
- Chrome vanadium satin finish sockets
- Designed and manufactured to DIN3120/3124 and ISO2725

Regular 12 point sockets:

	mm:	10	11	12	13	14	15	16	17	18
		19	20	21	22	24	27	30	32	

Item ID: **TTI217**



TT SERIES
1

18 Pieces 1/2 mm

1/2" SOCKET SET 6 PT TTI 18 PIECES

- 6 point single hexagon sockets
- Chrome vanadium satin finish sockets
- Designed and manufactured to DIN and ISO standards

72 Teeth ratchet, 2 1/2" & 10" Extension bars

Universal joint, 3/8" F x 1/2" M T-bar adaptor

Regular 6 point sockets:

	mm:	10	11	12	13	14	15	16	17	18
		19	22	24						

Item ID: **TTI218-6**



TT SERIES
1

18 Pieces 1/2 mm

1/2" SOCKET SET 12 PT TTI 18 PIECES

- 12 point bi-hexagon sockets
- Chrome vanadium satin finish sockets
- Designed and manufactured to DIN and ISO standards

72 Teeth ratchet, 2 1/2" & 10" Extension bars

Universal joint, 3/8" F x 1/2" M T-bar adaptor

Regular 12 point sockets:

	mm:	10	11	12	13	14	15	16	17	18
		19	22	24						

Item ID: **TTI218**



TT SERIES
 15 Pieces 1/2" AF

1/2" SOCKET SET 12 PT AF TTI 15 PIECES

- 12 point bi-hexagon sockets
- Chrome vanadium satin finish sockets
- Designed and manufactured to DIN3120 and ASME B107.1

Regular 12 point sockets:

AF:	3/8	7/16	1/2	9/16	5/8	11/16	3/4	13/16	7/8
	15/16	1	1-1/16	1-1/8	1-3/16	1-1/4			

Item ID: **TTI215AF**



TT SERIES
 16 Pieces 1/2" mm

1/2" HEX BIT SOCKET SET TTI 16 PIECES

- Chrome vanadium satin finish sockets
- Designed and manufactured to DIN7422

Hex bit sockets mm:													
Length 55mm:	5	6	7	8	9	10	12	14	17				
Length 100mm:	5	6	10	12	14	17							
Length 115mm:	8												

Item ID: **TTHEX16**



TT SERIES
 23 Pieces 1/2" mm

1/2" HEX BIT SOCKET SET TTI 23 PIECES

- Chrome vanadium satin finish bit holders included
- Grub screws to retain the bit in place, especially useful when working in difficult to reach places
- Designed and manufactured to DIN 3126 & ISO 1173

10mm Hex bit adaptor, 12mm Hex bit adaptor, 2mm Hex mini screwdriver													
Hex bit sockets mm:													
Length 40mm:	10mm Hex Drive:	5	6	7	8	9	10						
	12mm Hex Drive:	12	14	17	19								
Length 75mm:	10mm Hex Drive:	5	6	7	8	9	10						
	12mm Hex Drive:	12	14	17	19								

Item ID: **TTHEX23**



TT SERIES
 18 Pieces 1/2"

1/2" TX BIT SOCKET SET TTI 18 PIECES

- Chrome vanadium satin finish sockets
- Designed and manufactured to DIN and ISO standards

TX bit sockets:													
Length 55mm:	20	25	27	30	40	45	50	55	60				
Length 110mm:	20	25	27	30	40	45	50	55	60				

Item ID: **TTTX18**



TT SERIES
 23 Pieces 1/2"

1/2" TX BIT SOCKET SET TTI 23 PIECES

- Chrome vanadium satin finish bit holders included
- Grub screws to retain the bit in place, especially useful when working in difficult to reach places
- Designed and manufactured to DIN 3126 & ISO 1173

10mm Hex bit adaptor, 12mm Hex bit adaptor, 2mm Hex mini screwdriver													
TX bit sockets:													
Length 40mm:	10mm Hex Drive:	20	25	27	30	40	45	50	55				
	12mm Hex Drive:	60	70										
Length 75mm:	10mm Hex Drive:	20	25	27	30	40	45	50	55				
	12mm Hex Drive:	60	70										

Item ID: **TTTX23**



TT SERIES
 15 Pieces 1/2" mm

1/2" LONG HEX & TX BIT SOCKET SET TTI

- 100mm length for easier access in recesses
- Chrome vanadium satin finish sockets
- Designed and manufactured to DIN and ISO standards

TX bit sockets:													
Length 100mm:	20	25	27	30	40	45	50	55	60				
Hex bit sockets mm:													
Length 100mm:	5	6	7	8	10	12							

Item ID: **TTTXH15**



TT SERIES
 15 Pieces 1/2"

1/2" LONG RIBE & XZN BIT SOCKET SET TTI

- 100mm length for easier access in recesses
- Chrome vanadium satin finish sockets
- Designed and manufactured to DIN and ISO standards

Ribe bit sockets:													
Length 100mm:	4	5	6	8	10	11	12	13					
XZN bit sockets:													
Length 100mm:	5	6	8	10	12	14	16						

Item ID: **TTRS15**



TT SERIES
 13 Pieces 1/4" 3/8" 1/2"

EXTENSION BARS SET TTX4 13 PIECES

- Includes a selection of long and wobble extension bars
- TengTools T-HD handle included for a more comfortable grip
- Designed and manufactured to DIN and ISO standards

1/4" Drive	6" & 12" Extension bars, Universal joint
3/8" Drive	3" Wobble extension bar, 20" Extension bar, Universal joint, 3/8" F x 1/4" M T-bar adaptor
1/2" Drive	3" Wobble extension bar, 20" Extension bar, Universal joint
T-handle grip, 2mm & 2.5mm Mini Hex Screwdrivers	

Item ID: **TTXEXT13**



TT SERIES
x4
4 Pieces 3/4"

3/4" RATCHET & ACCESSORIES SET TTX4

- Socket accessory set
- Quick release and twist reverse action for easier use
- Sliding T bar and extension bars also included
- Designed and manufactured to DIN and ISO standards

Quick release 72 teeth ratchet, 200mm & 400mm Extension bars

Sliding T-bar

Item ID: **TTX3404**



TT SERIES
x4
4 Pieces 3/4"

3/4" RATCHET & ACCESSORIES SET SAFETY LOCK

- Socket accessory set
- With safety locking system to avoid tools being dropped
- Quick release and twist reverse action for easier use
- Sliding T bar and extension bars also included
- Designed and manufactured to DIN and ISO standards

Quick release 72 teeth ratchet, 200mm & 400mm Extension bars

Sliding T-bar

Item ID: **TTX3404S**



TT SERIES
x4
2 Pieces 3/4"

3/4" RATCHET & ACCESSORIES SET TTX4

- Ratchet with extendable handle 545 to 860mm
- Extension bar 16"
- Designed and manufactured according to DIN3122D

72 teeth 3/4" Drive Extendable Ratchet

16" Extension bar

Item ID: **TTX3402E**



TT SERIES
x4
14 Pieces 3/4" mm

3/4" SOCKET SET 6 PT TTX4 14 PIECES

- Chrome vanadium
- Satin finish for a better grip when handling the sockets
- 6 point single hexagon sockets for a better grip
- Designed and manufactured to DIN3120/3124

Regular 6 point sockets:

mm:	19	21	22	24	27	30	32	33	34
	36	38	41	46	50				

Item ID: **TTX3414**



TT SERIES
x4
14 Pieces 3/4" AF

3/4" SOCKET SET 12 PT AF TTX4 14 PIECES

- Chrome vanadium
- Satin finish for a better grip when handling the sockets
- 12 point bi-hexagon sockets
- Designed and manufactured to DIN3120 & ASME B107.1

Regular 12 point sockets:

AF:	7/8	15/16	1	1-1/16	1-1/8	1-3/16	1-1/4	1-5/16	1-3/8
	1-7/16	1-1/2	1-5/8	1-3/4	1-7/8				

Item ID: **TTX34AF**



TT SERIES
1
17 Pieces 1/4" 3/8" 1/2"

SOCKET ADAPTOR SET TTI 17 PIECES

- A selection of extension bars and adaptors in one handy set
- A full range of converters and adaptors from 1/4" to 1" drive
- Includes regular, magnetic and quick chuck holders for use with 1/4" hex bits
- Designed and manufactured to DIN standard

1/4" Drive:	1/4" Hex Coupler, Hex bit adaptor, 50mm Hex bit adaptor
3/8" Drive:	1/4" Hex Coupler, Hex bit adaptor, 50mm Hex bit adaptor
1/2" Drive:	50mm Hex bit adaptor
Step Up Adaptors:	1/4" F x 3/8" M 3/8" x 1/2" M 1/2" F x 3/4" F 3/4" M - 1" F
Reducing Adaptors:	3/8" F x 1/4" M 1/2" F x 3/8" M 3/4" F x 1/2" M
	50mm & 70mm Magnetic bit holder, 50mm Chuck bit holder with quick release

Item ID: **TTADP17**



TT SERIES
1
24 Pieces 1/4" 3/8" mm

1/4" & 3/8" IMPACT SOCKET SET ANSI TTI

- Chrome molybdenum for use with power tools
- ANSI standard design for use with power tools with a ball bearing socket retainer

3/8" F x 1/4" M impact adaptor

1/4" Drive Impact 6 point sockets:

Reg mm:	6	7	8	10	13
---------	---	---	---	----	----

3/8" Drive Impact 6 point sockets:

Reg mm:	8	10	11	12	13	14	16	17	19
---------	---	----	----	----	----	----	----	----	----

Deep mm:	8	10	11	12	13	14	16	17	19
----------	---	----	----	----	----	----	----	----	----

Item ID: **TT9024**



TT SERIES
1
11 Pieces 1/2"

1/2" IMPACT SOCKET ACCESSORIES SET DIN TTI

- A selection of extension bars and adaptors
- DIN standard design for use with a retaining pin and ring
- Chrome molybdenum for use with power tools

Impact Adaptors: 3/8" F x 1/2" M, 1/2" F x 3/8" M, 1/2" F x 3/4" M

Universal Joint, 3", 5" & 10" Extension bars

Retaining rings & pins: O92194, O92244, P92320, P92325 x1

Item ID: **TT9207**



TT SERIES
1

11 Pieces 1/2" mm

1/2" IMPACT SOCKET ACCESSORIES SET ANSI TTI

- A selection of extension bars and adaptors
- For use with ANSI sockets
- Chrome molybdenum for use with power tools

Impact Adaptors:	3/8" F x 1/2" M, 1/2" F x 3/8" M, 1/2" F x 3/4" M
Universal Joint, 3", 5" & 10" Extension bars	
Retaining rings & pins:	O92194, O92244, P92320, P92325 x1

Item ID: **TT9207A**

TT SERIES
1

12 Pieces 1/2" mm

1/2" IMPACT SOCKET SET DIN TTI 12 PIECES

- DIN standard design for use with a retaining pin and ring
- Chrome molybdenum for use with power tools
- O-rings & pins included
- Designed and manufactured to DIN3129

Retaining rings & pins:	O92244, P92325 x1
1/2" Drive Impact 6 point sockets:	
Reg mm:	19 21 22 24 27 30 32
Deep mm:	19 21 22 24 27

Item ID: **TT9212**

TT SERIES
1



16 Pieces 1/2" mm

1/2" IMPACT SOCKET SET ANSI TTI 16 PIECES

- ANSI standard design for use with power tools with a ball bearing socket retainer
- Chrome molybdenum for use with power tools

1/2" Drive Impact 6 point sockets:	
Reg mm:	13 15 16 17 18 19 22 24
Deep mm:	13 15 16 17 18 19 22 24

Item ID: **TT9116N**

TT SERIES
1

20 Pieces 1/2" mm

1/2" IMPACT SOCKET SET DIN TTI 20 PIECES

- DIN standard design for use with a retaining pin and ring
- Chrome molybdenum for use with power tools
- Designed and manufactured to DIN3129

Retaining rings & pins:	O92194, O92244, P92320, P92325 x1
1/2" Drive Impact 6 point sockets:	
Reg mm:	13 15 16 17 18 19 22 24
Deep mm:	13 15 16 17 18 19 22 24

Item ID: **TT9120DN**

TT SERIES
1

12 Pieces 1/2" mm

1/2" TX IMPACT SOCKET SET DIN TTI

- Chrome molybdenum for use with power tools
- DIN standard design for use with a retaining pin and ring

1/2" Drive Impact TX bit sockets:	
TX:	10 15 20 25 27 30 40 45
	50 55 60 70

Item ID: **TT9212TX**

TT SERIES
1



8 Pieces 1/2" mm

1/2" TORQUE STICKS & WHEEL NUT SET TTI

- For the correct tightening of wheel nut sockets on cars
- When the correct torque is reached the torque stick socket end stops turning while the drive end springs back with each stroke
- Reduces the risk of sheared wheel nut bolts or distorted rims and brake discs
- Chrome molybdenum wheel nut sockets with protective inserts to avoid damage to wheels

3/8" x 1/2" Torque step up adaptor	
1/2" Drive Torque sticks:	
Nm:	90 110 120 140
1/2" Drive wheel nut sockets:	
mm:	17 19 21

Item ID: **TTTS08**



TT SERIES
1

15 Pieces 3/8" 1/2" mm

3/8" & 1/2" HEX IMPACT SOCKET SET DIN TTI

- Chrome molybdenum for use with power tools
- DIN standard design for use with a retaining pin and ring
- Designed and manufactured to DIN3129

3/8" Drive Impact Hex bit sockets:	
mm:	4 5 6 7 8 10 12
1/2" Drive Impact Hex bit sockets:	
mm:	5 6 8 10 12 14 17 19

Item ID: **TT9015HX**

TT SERIES
2



16 Pieces 3/4" mm

3/4" IMPACT SOCKET SET DIN TT2 16 PIECES

- 7" impact extension bar included for reaching in to recessed wheels, etc
- DIN standard design for use with a retaining pin and ring (included)
- Chrome molybdenum for use with power tools
- Supplied in the unique TengTools TT2 tray

7" Extension bar	
Retaining rings & pins:	O95036 x3, P90435 x3
3/4" Drive Impact 6 point sockets:	
Reg mm:	19 (3/4") 24 27 (1-1/16") 30 (1-3/16") 32 33
	34 36 38

Item ID: **TTD9416**



TT SERIES
x4

15 Pieces 3/4" mm

3/4" IMPACT SOCKET SET DIN TTX4 15 PIECES

- DIN standard design for use with a retaining pin and ring
- Chrome molybdenum for use with power tools
- Supplied in the unique TengTools drawer width TTX4 tray

3/4" Drive Impact 6 point sockets:

Reg mm:	19 (3/4")	24	27 (1-1/16")	28
	30 (1-3/16")	32	34	36
Deep mm:	19 (3/4")	24	27 (1-1/16")	
	30 (1-3/16")	32	33	36

Item ID: **TTX9415**



TT SERIES
1

20 Pieces 1/2"

1/2" IMPACT DRIVER SET TTI 20 PIECES

- Includes a range of impact bits for removing stubborn fastenings

Reversible impact driver, coupler adaptor, 5/16" Hex x 1/2" adaptor

5/16" Hex bits:	6, 8, 10, 12	PH1, PH2, PH3, PH4
Length 36mm	4, 5, 6, 8	TX30, TX40, TX45, TX50, TX55

Item ID: **TTID20**



TT SERIES
1

19 Pieces 1/4"

1/4" IMPACT DRIVER SET TTI 19 PIECES

- Includes a range of impact bits, impact sockets and screw extractors
- A complete set for removing stubborn fastenings

1/4" Drive reversible impact driver, Impact Bit Adaptor, 1/4" Hex x 1/4" adaptor

1/4" Drive Impact 6 point sockets:

Reg mm:	8	10	13
---------	---	----	----

Screw Extractors: 1 2 3

1/4" Hex Impact Bits:	3, 4, 5, 6	TX25, TX30, TX40
Length 50mm	PH2, PH3	PZ2, PZ3

Item ID: **TTID19**

TORQUE TOOLS



TT SERIES
1

38 Pieces 1/4"

TORQUE SCREWDRIVER SET TTI 38 PIECES

- Includes a 1-5Nm 1/4" drive torque screwdriver
- Accurate to +/- 6% and conforms to ISO6789 for assured accuracy
- Wide range of screwdriver bits and accessories
- Removable lid and dove tail joints

1-5Nm Torque screwdriver, 1/4" M x 1/4" Hex adaptor

1/4" Hex bits:	3, 4.5, 5.5, 6.5	PH0, PH1, PH2, PH3
Length 25mm	2, 3, 4, 5, 6	PZ0, PZ1, PZ2, PZ3 ROB1, 2, 3
	TX8, TX9, TX10, TX15, TX20, TX25, TX27, TX30, TX40	
	TPX10, TPX15, TPX20, TPX30, TPX40	PH2G (x2)

Item ID: **TTSD38**



TT SERIES
x4

22 Pieces 3/8"

3/8" TORQUE WRENCH SET 20-110 NM TTX4

- Ideal set for automotive technicians
- Equipped with an in-built angular gauge for easier after tightening
- Click type mechanism when the required torque is reached
- Additional ft/lb reference scale (range 15-81 ft/lb)
- Marked to show the correct place where pressure should be applied
- Twist locking facility to ensure the set torque is maintained
- Reversible 24 teeth ratchet (DIN3122) giving 15° increments
- Designed to torque right hand (clockwise) fasteners
- Accurate to +/- 4% conforms to ISO6789 for assured accuracy
- Individually tested and certified at the time of manufacture

3/8" Drive Torque wrench (20-110Nm, 15-81 ft/lb), 3" and 5" extension bars, adaptor for 10mm hex bits

10mm Hex Drive TX bits:

TX8, TX10, TX15, TX20, TX25, TX27, TX30, TX40

3/8" Drive Crow Foot Wrenches

10, 11, 12, 13, 14, 15, 16, 17, 18, 19 mm

Item ID: **TTX3892**



TT SERIES
x4

1 Piece 1/2"

1/2" TORQUE WRENCH 40-210 NM TTX4

- Equipped with an in-built angular gauge for easier after tightening
- Additional ft/lb reference scale (range 30-150 ft/lb)
- Marked to show the correct place where pressure should be applied
- Twist locking facility to ensure the set torque is maintained
- Reversible 24 teeth ratchet (DIN3122) giving 15° increments
- Designed to torque right hand (clockwise) fasteners
- Accurate to +/- 4% conforms to ISO6789 for assured accuracy
- Individually tested and certified at the time of manufacture

1/2" Drive Torque wrench (40-210Nm, 30-150 ft/lb)

Item ID: **TTX1292**



TT SERIES
x4

1 Piece 1/2"

1/2" TORQUE WRENCH P-SERIES 40-200 NM TTX4

- Click type mechanism to signal when the required torque is reached
- Simple to adjust and easy to read Nm scale
- Locking button to ensure the set torque is securely maintained
- Compact head for easier use in confined spaces
- Quick release 72 teeth ratchet mechanism with twist reverse (DIN3122)
- Designed to torque right hand (clockwise) fasteners
- Ergonomic bi-material grip for added comfort
- Marked to show the correct place where pressure should be applied
- Hanging facility which can be used together with a fall protection wire
- Accurate to +/- 4% and conforms to ISO6789 for assured accuracy
- Each torque wrench has it's own individual certification number

1/2" Drive P-SERIES Torque wrench (40-200Nm)

Item ID: **TTXP1292**



TT SERIES
x4

2 Pieces 1/2" 3/4"

1/2" TORQUE MULTIPLIER SET TTX4 2 PIECES

- Includes a 1/2" drive torque wrench giving a range of 40 to 210Nm
- The MP1400 torque multiplier can be used to multiply the torque at a ratio of 1:3 increasing the potential torque to 630Nm
- For use with 3/4" drive sockets

1/2" Drive Torque wrench (40-210Nm, 30-150 ft/lb)

1/2" F:3/4" M Torque multiplier (1 to 3 ratio) and maximum torque capacity 1,500Nm

Item ID: **TTXMP12**

SPANNERS & WRENCHES



12 Pieces mm

COMBINATION SPANNER SET ANTI SLIP TTI

- Off set at 15° for easier use on flat surfaces
- TengTools hip grip design for contact with the flat side of the fastening
- TengTools anti slip design on the open end to give a much better grip

Combination Spanners:

8, 9, 10, 11, 12, 13, 14, 15, 16, 17, 18, 19 mm



Item ID: TT8012



10 Pieces mm

STUBBY COMBINATION SPANNER SET TTI

- Short stubby spanners for use in confined spaces
- Off set at 15° for easier use on flat surfaces
- TengTools hip grip design for contact with the flat side of the fastening
- Chrome vanadium satin finish
- Designed and manufactured to DIN3113A

Midget Combination Spanners:

10, 11, 12, 13, 14, 15, 16, 17, 18, 19 mm

Item ID: TT6010M



12 Pieces mm

COMBINATION SPANNER SET TTI 12 PIECES

- Off set at 15° for easier use on flat surfaces
- TengTools hip grip design for contact with the flat side of the fastening
- Chrome vanadium satin finish
- Designed and manufactured to DIN3113A

Combination Spanners:

8, 9, 10, 11, 12, 13, 14, 15, 16, 17, 18, 19 mm

Item ID: TT1236



8 Pieces AF

COMBINATION SPANNER SET AF TTI 8 PIECES

- Off set at 15° for easier use on flat surfaces
- TengTools hip grip design for contact with the flat side of the fastening
- Chrome vanadium satin finish
- Designed and manufactured to ASME B107.100

Combination Spanners:

5/16", 3/8", 7/16", 1/2", 9/16", 5/8", 11/16", 3/4"

Item ID: TT3592



7 Pieces mm

COMBINATION SPANNER SET TTX4 7 PIECES

- Chrome vanadium, satin finish
- Off set at 15° for easier use on flat surfaces
- TengTools hip grip design for contact with the flat side of the fastening
- Designed and manufactured to DIN3113A

Combination Spanners:

20, 21, 22, 24, 27, 30, 32 mm

Item ID: TTX2032



7 Pieces AF

COMBINATION SPANNER SET AF TTX4 7 PIECES

- Chrome vanadium, satin finish
- Off set at 15° for easier use on flat surfaces
- TengTools hip grip design for contact with the flat side of the fastening
- Designed and manufactured to ASME B107.100

Combination Spanners:

13/16", 7/8", 15/16", 1", 1-1/16", 1-1/8", 1-1/4"

Item ID: TTX2640



12 Pieces mm

LONG COMBINATION SPANNER SET TTX4

- Extra long for increased torque
- Off set at 15° for easier use on flat surfaces
- TengTools hip grip design for contact with the flat side of the fastening
- Designed and manufactured to DIN3113A

Long Combination Spanners:

8, 9, 10, 11, 12, 13, 14, 15, 16, 17, 18, 19 mm

Item ID: TTXLMP12



8 Pieces mm

RATCHETING COMBI SPANNER SET R TTI

- 72 teeth ratchet spanners giving a 5° increment between clicks
- Reversible ratchet mechanism with a flip reverse lever
- TengTools hip grip design on the ring end
- Chrome vanadium satin finish
- Designed and manufactured to DIN ISO 1711-1 and DIN 3113A

Ratchet Spanners with flip reverse switch:

8, 10, 11, 12, 13, 14, 17, 19 mm

Item ID: TT6508R



TT SERIES
1

11 Pieces mm

RATCHETING COMBI SPANNER SET R TTI

- 72 teeth ratchet spanners giving a 5° increment between clicks
- Reversible ratchet mechanism with hip grip & flip reverse lever
- Chrome vanadium satin finish
- Designed and manufactured to DIN ISO 1711-1 and DIN 3113A

Ratchet Spanners with flip reverse switch:

8, 10, 11, 12, 13, 14, 15, 16, 17, 18, 19 mm

Item ID: **TT6511R**



TT SERIES
1

8 Pieces mm

RATCHETING COMBI SPANNER SET RF TTI

- 72 teeth ratchet spanners giving a 5° increment between clicks
- Flexible head for use at an angle or for reversing the direction of use when ratcheting
- Chrome vanadium satin finish
- Removable lid and dove tail joints

Flexible head Ratchet Spanners:

8, 10, 11, 12, 13, 14, 17, 19 mm

Item ID: **TT6508RF**



TT SERIES
1

8 Pieces mm

RATCHETING COMBI SPANNER SET RS TTI

- 72 teeth ratchet spanners giving a 5° increment between clicks
- Simply turn over to reverse the direction of use when ratcheting
- Chrome vanadium satin finish
- Designed and manufactured to DIN ISO 1711-1 & DIN 3113A

Ratchet Spanners:

8, 10, 11, 12, 13, 14, 17, 19 mm

Item ID: **TT6508RS**



TT SERIES
x4

11 Pieces mm

DOUBLE RING SPANNER SET TTX4 11 PIECES

- Different size at each end to give 22 sizes in total
- Double curved heads offset at 75° for easier use on flat surfaces
- Chrome vanadium satin finish
- TengTools hip grip design for contact with the flat side of the fastening
- Designed and manufactured to DIN838

Double Ring Spanners:

6x7, 8x9, 10x11, 12x13, 14x15, 16x17, 18x19, 20x22, 21x23, 24x27, 30x32 mm

Item ID: **TTX6311**



TT SERIES
1

8 Pieces AF

RATCHETING COMBI SPANNER SET R AF TTI

- 72 teeth ratchet spanners giving a 5° increment between clicks
- Reversible ratchet mechanism with a flip reverse lever
- Chrome vanadium satin finish
- Manufactured to DIN ISO 1711-1 and ASME B107.100

Ratchet Spanners with flip reverse switch:

5/16", 3/8", 7/16", 1/2", 9/16", 5/8", 11/16", 3/4"

Item ID: **TT6508RAF**



TT SERIES
1

10 Pieces mm

STUBBY RATCHETING SPANNER SET RS TTI

- Short stubby spanners for use in confined spaces.
- 72 teeth ratchet spanners giving a 5° increment between clicks.
- Hip Grip on the ring end, turn spanner over to change direction.
- Chrome vanadium satin finish

Stubby Ratchet Spanners:

10, 11, 12, 13, 14, 15, 16, 17, 18, 19 mm

Item ID: **TT6010MRS**



TT SERIES
1

11 Pieces mm

RATCHETING COMBI SPANNER SET RS TTI

- 72 teeth ratchet spanners giving a 5° increment between clicks
- Hip grip on the ring end, turn spanner over to change direction
- Chrome vanadium satin finish
- Designed and manufactured to DIN ISO 1711-1 and DIN 3113A

Ratchet Spanners:

8, 10, 11, 12, 13, 14, 15, 16, 17, 18, 19 mm

Item ID: **TT6511RS**



TT SERIES
x4

7 Pieces AF

DOUBLE RING SPANNER SET AF TTX4 7 PIECES

- Different size at each end to give 12 sizes in total
- Double curved heads offset at 75° for easier use on flat surfaces
- Chrome vanadium satin finish
- TengTools hip grip design for contact with the flat side of the fastening

Double Ring Spanners:

1/4" x 5/16", 3/8" x 7/16", 7/16" x 1/2", 13/16" x 7/8", 15/16" x 1-1/16", 1" x 1-1/8", 1-1/8" x 1-1/4"

Item ID: **TTX6707**



TT SERIES
x4

6 Pieces mm

LONG DOUBLE RING SPANNER SET TTX4

- Different size at each end to give 12 sizes in total
- Extra long, flat design for extra torque
- Chrome vanadium satin finish
- TengTools hip grip design for contact with the flat side of the fastening
- Designed and manufactured to DIN837

Extra long Double Ring Spanners:

8x10, 11x13, 12x14, 16x18, 17x19, 22x24 mm

Item ID: **TTXFLS06**



TT SERIES
x4

7 Pieces AF

DOUBLE OPEN ENDED SPANNER SET AF TTX4

- Different size at each end to give 14 sizes in total
- Chrome vanadium satin finish
- TengTools hip grip design for contact with the flat side of the fastening
- Designed and manufactured to ASME B107.100

Double Open Ended Spanners:

1/4" x 5/16", 3/8" x 7/16", 1/2" x 9/16", 5/8" x 3/4",
13/16" x 7/8", 15/16" x 1", 1-1/8" x 1-1/4"

Item ID: **TTX6607**



TT SERIES
1

8 Pieces mm

DOUBLE OPEN ENDED SPANNER SET TTI

- Different size at each end to give 16 sizes in total
- Open at each end off set at 15° for easier use
- Chrome vanadium satin finish
- Designed and manufactured to DIN3110

Double Open Ended Spanners:

6x7, 8x9, 10x11, 12x13, 14x15, 16x17, 18x19, 20x22 mm

Item ID: **TT6208**



TT SERIES
1

6 Pieces mm

DOUBLE FLEX WRENCH SET TTI 6 PIECES

- Swivel end wrenches for fast pre-tightening and loosening
- Angle at 90° for added torque when applying the final tightening
- Extra torque for loosening stubborn fastenings
- Chrome vanadium satin finish
- Designed and manufactured to DIN standard

Double Flex Wrenches

8x9, 10x11, 12x13, 14x15, 16x17, 18x19 mm

Item ID: **TT6506**



TT SERIES
x4

7 Pieces mm

QUICK WRENCH SET TTX4 7 PIECES

- Special design for loosening and tightening pipe and hose couplings
- Ideal for use in confined spaces
- Ring end has a clever design so that it opens up easily to access the nut on the coupling

Quick Wrenches:

13, 17, 19, 22, 24, 27, 32 mm

Item ID: **TTXQRS07**



TT SERIES
1

6 Pieces mm

RATCHETING RING SPANNER SET TTI 6 PIECES

- Fibre reinforced reversible ratchet wrenches
- 18 teeth for extra strength and use in outdoor sites
- Double ended with 25° offset heads
- 12 point ring ends (6x8mm is 6 point)
- Chrome vanadium satin finish with FRP bodies

RORS Wrenches:

6x8, 7x9, 10x13, 12x14, 17x19, 21x22 mm

Item ID: **TTRORS**



TT SERIES
1

8 Pieces mm

HOOK & PIN WRENCH SET TTI 8 PIECES

- Includes a range of handles, pin and hook adaptors
- Chrome vanadium satin finish
- To be used for nuts designed and manufactured to DIN1804 & 1816
- Wrench manufactured to DIN1810

Hook & Pin Wrenches

Hook Handles: 3/4" to 2", 1-1/4" to 3", 2" to 4-3/4"

Pin Adaptors: 4, 5, 6 mm

Pins: 6, 8 mm

Item ID: **TTHP08**



TT SERIES
1

4 Pieces mm TPR GRIP

ADJUSTABLE WRENCH SET TTI 4 PIECES

- Includes an 8" wide jaw adjustable wrench for added versatility
- Designed and manufactured to ISO6787

Adjustable Wrenches

6" (150 mm) Capacity: 24 mm

8" (200 mm) Capacity: 28 mm

10" (250 mm) Capacity: 33 mm

8" (200 mm) Wide Jaw Capacity: 38 mm

Item ID: **TTADJ04**

SCREWDRIVERS

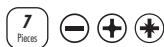

SCREWDRIVER SET MIXED TT1 7 PIECES

- TT-MV PLUS steel alloy for greater strength and material flexibility
- Ergonomically designed bi-material handle for easy use with higher torque
- Hanging hole in the handle for use as a T handle or with a fall protection wire
- The handle is moulded around the blade to give a higher torque capacity

Screwdrivers:				
mm:	3 x 75	5.5 x 75	6.5 x 100	
mm:	PH0 x 75	PH1 x 75	PH2 x 100	
mm:	PZ2 x 100			

Item ID: TT917N



SCREWDRIVER SET MIXED TT2 14 PIECES

- TT-MV PLUS steel alloy for greater strength and material flexibility
- Ergonomically designed bi-material handle for easy use with higher torque
- Hanging hole in the handle for use as a T handle or with a fall protection wire
- The handle is moulded around the blade to give a higher torque capacity

Screwdrivers:				
mm:	3 x 75	3.5 x 100	5.5 x 75	5.5 x 125
	6.5 x 38	6.5 x 100		
mm:	PH0 x 75	PH1 x 75	PH2 x 38	PH2 x 100
mm:	PZ0 x 75	PZ1 x 75	PZ2 x 38	PZ2 x 100

Item ID: TTD914N



SCREWDRIVER SET FLAT & PH TTX4 8 PIECES

- TT-MV PLUS steel alloy for greater strength and material flexibility
- Ergonomically designed bi-material handle for easy use with higher torque
- Hanging hole in the handle for use as a T handle or with a fall protection wire
- The handle is moulded around the blade to give a higher torque capacity

Screwdrivers:				
mm:	6.5 x 38	3 x 100	6.5 x 100	10 x 200
	5.5 x 150	8 x 150		
mm:	PH2 x 38	PH3 x 150		

Item ID: TTX918N



SCREWDRIVER SET TX & TPX TT1 7 PIECES

- TT-MV PLUS steel alloy for greater strength and material flexibility
- Ergonomically designed bi-material handle for easy use with higher torque
- Hanging hole in the handle for use as a T handle or with a fall protection wire
- The handle is moulded around the blade to give a higher torque capacity

Screwdrivers:			
mm:	TX6 x 75	TX9 x 75	
mm:	TPX10 x 100	TPX15 x 100	TPX20 x 100
	TPX25 x 100	TPX30 x 100	

Item ID: TT917TXN



SCREWDRIVER SET TX TT2 12 PIECES

- TT-MV PLUS steel alloy for greater strength and material flexibility
- Ergonomically designed bi-material handle for easy use with higher torque
- Hanging hole in the handle for use as a T handle or with a fall protection wire
- The handle is moulded around the blade to give a higher torque capacity

Screwdrivers:				
mm:	TX6 x 75	TX7 x 75	TX8 x 75	TX9 x 75
	TX10 x 100	TX15 x 100	TX20 x 100	TX25 x 100
	TX27 x 100	TX30 x 100	TX40 x 100	TX45 x 125

Item ID: TTD912TXN



SCREWDRIVER BLADE SET MIXED TT1 12 PIECES

- 22 screwdrivers in one set
- TT-MV PLUS steel alloy for greater strength and material flexibility
- Ergonomically designed bi-material handle for easy use with higher torque
- Hanging hole in the handle for use as a T handle or with a fall protection wire

Screwdriver Blade Handle With 1/4" Shank					
Screwdriver Blades:					
mm:	4 - 5.5				
	PH1 - PH2				
mm:	PH3 - 6.5				
	PZ1 - PZ2				
mm:	3 Ball - 3	4 Ball - 4	5 Ball - 5	6 Ball - 6	
TX:	10 - 15	20 - 25	30 - 40		

Item ID: TTMD12D



POWER THROUGH SCREWDRIVER SET TTX4

- Chrome vanadium blades for greater strength and material flexibility
- Percussion cap and full length integral blade for use with a hammer to release stubborn screws
- Ergonomically designed bi-material handle for easy use with higher torque and faster speed
- The handle is moulded around the blade to ensure straightness and to allow larger blade wings which give a higher torque capacity

Screwdrivers:			
mm:	6.5 x 100	8 x 150	10 x 200
mm:	PH2 x 100	PH3 x 150	

Item ID: TTXMDTN



TT SERIES
1

16 Pieces

MINI PLIERS & SCREWDRIVER SET TTI 16 PIECES

- Mini screwdrivers feature a rotating end piece for easier use when "transporting" the fastening
- Mini pliers feature high carbon steel construction and vinyl grip handles

Mini Screwdrivers:		
	mm: 2.0 x 40	2.4 x 40 3.0 x 40
	mm: PH00 x 40	PH0 x 40 PH1 x 40
	mm: TX6 x 40	TX7 x 40 TX8 x 40
	TX9 x 40	TX10 x 40 TX15 x 40
Mini Pliers:		
4 1/2"	SIDE CUTTER	
4 1/2"	END CUTTER	
5"	LONG NOSE PLIER	
5"	FLAT NOSE PLIER	

Item ID: **TTMI16**



TT SERIES
x4

9 Pieces mm

NUT DRIVER SET TTX4 9 PIECES

- 6 point socket ends for a perfect fit
- Chrome vanadium for greater strength and material flexibility
- Ergonomically designed bi-material handle for easy use with higher torque
- Hanging hole in the handle for use as a T handle or for use with a fall protection wire
- The handle is moulded around the blade which give a higher torque capacity

Nut Drivers:	
	5, 5.5, 6, 7, 8, 10, 11, 12, 13 mm

Item ID: **TTXND**

BITS & DRIVER SETS



TT SERIES
1

49 Pieces 1/4"

BITS DRIVER SET TTI 49 PIECES

- Comprehensive selection of 25mm and 89mm 1/4" drive hex bits
- 1/4" drive regular sockets from 4 to 13mm
- Various drivers and accessories for use with bits and/or sockets

147mm Quick chuck driver, 1/4" drive ratchet head adaptor, 1/4"M x 1/4" Hex adaptor			
1/4" Drive Regular 6 point sockets:			
	mm:	4, 5, 5.5, 6, 7, 8, 9, 10, 11, 12, 13 mm	
1/4" Hex bits:			
Length 25mm:		3.5, 5.5, 8 mm	
		PH1, PH2, PH3	
		TX10, TX15, TX20, TX25, TX30, TX40	
		TPX20, TPX25, TPX30	
		ROB1, 2, 3	
Length 89mm:		PH1, PH2	
		4 mm	
		TX10, TX20, TX25	
		4 mm	

Item ID: **TTMDQ49**



TT SERIES
1

76 Pieces 1/4"

BITS DRIVER SET TTI 76 PIECES

- Quick chuck magnetic bits driver and adaptor for use with bits and/or sockets

217mm Quick chuck screwdriver handle, 1/4"M x 1/4" Hex adaptor				
1/4" Drive Regular 6 point sockets:				
	mm: 4, 5, 5.5, 6, 7, 8, 9, 10, 11, 12, 13 mm			
1/4" Hex bits:				
Length 25mm:		3.5, 4.0, 4.5, 5.5 (x2), 6.5, 8.0 mm		PH2G (x3)
		PH1 (x3), PH2 (x6), PH3		ROB1, 2, 3
		TX6, TX7, TX8, TX9, TX10, TX15, TX20 (x3), TX25 (x3), TX27, TX30, TX40		
		TPX10, TPX15, TPX20 (x2), TPX25 (x2), TPX27, TPX30, TPX40		
		PZ1 (x3), PZ2 (x6), PZ3		2, 3, 4, 5, 6, 8

Item ID: **TTMDQ76**



TT SERIES
1

62 Pieces 1/4"

T-HANDLE BITS DRIVER SET TTI 62 PIECES

- Comprehensive selection of 25mm 1/4" drive hex bits included
- T-handle bits driver with quick chuck adaptor on the long end and a magnetic bits holder on the short end

75mm Quick chuck T handle, 1/4"M x 1/4" Hex adaptor				
1/4" Drive Regular 6 point sockets:				
	mm: 5, 5.5, 6, 7, 8, 9, 10, 11, 12, 13 mm			
1/4" Drive TX-E bit sockets:				
	TX-E: E4, E5, E6, E7, E8			
1/4" Hex bits:				
Length 25mm:		3.5, 5.5, 8 mm		PZ1, PZ2, PZ3
		PH1, PH2, PH3		2, 3, 4, 5, 6, 8
		TX6, TX7, TX8, TX9, TX10, TX15, TX20 (x3), TX25 (x3), TX27, TX30, TX40		
		TPX10, TPX15, TPX20 (x2), TPX25 (x2), TPX27, TPX30, TPX40		
		PH2G (x3)		ROB1, 2, 3

Item ID: **TTTHQ62**



TT SERIES



84 Pieces

1/4"

RATCHETING BITS DRIVER SET TTI 84 PIECES

- Reversible ratcheting bits driver, flexible extension and adaptor for use with bits and/or sockets

Ratcheting Quick chuck screwdriver handle, 1/4" M x 1/4" Hex adaptor, 150mm flexible extension bar

1/4" Drive Regular 6 point sockets:

mm: 4, 5, 5.5, 6, 7, 8, 9, 10, 11, 12, 13 mm

1/4" Hex bits:

- Length 25mm:
- PH1 (x3), PH2 (x6), PH3
 - PH2G (x3)
 - ROB1, 2, 3
 - TX6, TX7, TX8, TX9, TX10, TX15, TX20 (x3), TX25 (x3), TX27, TX30, TX40
 - TPX10, TPX15, TPX20 (x2), TPX25 (x2), TPX27, TPX30, TPX40
 - PZ1 (x3), PZ2 (x6), PZ3
 - 2, 3, 4, 5, 6, 8

Item ID: TTMDR84



TT SERIES



38 Pieces

BITS DRIVER SET TTI 38 PIECES

- An extensive range of 1/4" hex drive 25mm screwdriver bits
- 2 quick chuck magnetic bit driver handles included giving a choice of shaft lengths
- Removable lid and dove tail joints

147mm & 183mm Quick chuck screwdriver handles

1/4" Hex bits:

- Length 25mm:
- 3.5, 5.5, 8 mm
 - PH1, PH2, PH3
 - PZ1, PZ2, PZ3
 - ROB1, 2, 3
 - TX10, TX15, TX20, TX25, TX30, TX40
 - TPX20, TPX25, TPX30
 - 2, 3, 4, 5, 6, 8
- Length 89mm:
- PH1, PH2
 - 3, 4 mm
 - PZ1, PZ2
 - TX10, TX20, TX25

Item ID: TTMDQ38



TT SERIES



74 Pieces

RATCHETING SCREWDRIVER BIT SET TTI

- An extensive range of 1/4" hex drive 25mm screwdriver bits
- Reversible, magnetic, ratcheting bits driver, extension bars and adaptors included
- Removable lid and dove tail joints

Ratcheting bits handle, 6" flexible extension, 4" extension, 1/4" M:1/4" hex coupler adaptor, 1/4" F x 1/4" hex coupler adaptor

1/4" Hex bits:

- Length 25mm:
- 3.5, 4.0, 4.5, 5, 5.5 (x2), 6.5, 7, 8 mm
 - PH2G
 - PH1 (x4), PH2 (x7), PH3
 - ROB1, 2, 3
 - TX6, TX7, TX8, TX9, TX10, TX15, TX20 (x3), TX25 (x3), TX27, TX30, TX40
 - TPX10, TPX15, TPX20 (x2), TPX25 (x2), TPX27, TPX30, TPX40
 - PZ1 (x4), PZ2 (x7), PZ3
 - 2, 3, 4, 5, 6, 8

Item ID: TTMD74



TT SERIES



64 Pieces

1/4"

ANGLED RATCHETING BITS DRIVER SET TTI

- Comprehensive selection of 25mm 1/4" drive hex bits
- Ratcheting magnetic bits driver with an adjustable handle angle to create a pistol type grip driver
- Removable lid and dove tail joints

Bits driver with adjustable angle setting, 1/4" M x 1/4" hex coupler adaptor

1/4" Drive Regular 6 point sockets:

mm: 4, 5, 5.5, 6, 7, 8, 9, 10, 11, 12, 13 mm

1/4" Hex bits:

- Length 25mm:
- 3.5, 4, 4.5, 5, 5.5 (x2), 6.5, 7, 8 mm
 - PH1 (x4), PH2 (x4), PH3 (x2)
 - ROB1, 2, 3
 - TX6, TX7, TX8, TX9, TX10, TX15, TX20 (x3), TX25 (x3), TX27, TX30, TX40
 - PZ1, PZ2 (x3), PZ3 (x2)
 - 2, 3, 4 (x3), 5, 6, 8

Item ID: TTMDRT64



TT SERIES



41 Pieces

1/4"

SOCKET & BIT SET FLEXIBLE HANDLE TTX4

- Long reach bit and socket drivers set
- Comprehensive selection of 25mm 1/4" drive hex bits
- 1/4" drive regular sockets from 4 to 13mm
- Ideal for use in difficult to reach places

555mm flexible spinner handle with 1/4" drive, 555mm flexible bits driver with 1/4" hex drive, 1/4" M x 1/4" hex coupler adaptor

1/4" Drive Regular 6 point sockets:

mm: 4, 4.5, 5, 5.5, 6, 7, 8, 9, 10, 11, 12, 13 mm

1/4" Hex bits:

- Length 25mm:
- 4, 5.5, 8 mm
 - 3, 4, 5, 6, 8, 10
 - PH0, PH1, PH2, PH3, PH4
 - PZ0, PZ1, PZ2, PZ3
 - TX8, TX10, TX15, TX20, TX25, TX27, TX30, TX40

Item ID: TTXMD41N



TT SERIES



53 Pieces 1/4"

IMPACT BIT SET TTI 53 PIECES

- Screwdriver, hex and TX bits in various lengths
- Metric and AF impact nut setters included
- New design impact bits and adaptors for higher torsion
- Suitable for use with power tools

60mm Impact magnetic bit holder, 60mm Impact quick chuck bit holder

1/4" Drive Impact nut setters - Length 65mm

Size: 1/4" 8 10 13

1/4" Hex Impact Bits: PH1, PH2 (x2), PH3 PH2G (x2) 1, 2
Length 30mm PZ1, PZ2 (x2), PZ3 3, 4 (x2), 5, 6

1/4" Hex Impact Bits: TX10, TX15, TX20 (x2), TX25 (x2), TX27, TX30 (x2), TX40

1/4" Hex Impact Bits: TX10, TX15, TX20, TX25, TX27, TX30, TX40
3, 4, 5, 6 PH2G 1, 2, 3 PZ2

1/4" Hex Impact Bits: TX20, TX25, TX30 PH2 (x2)
Length 89mm

Item ID: **TTBS53**

HEX & TX KEYS



TT SERIES



7 Pieces mm

T-HANDLE BALL POINT HEX KEY SET TTI

- Ball point end on the long key end giving access at angles of up to 25°
- Regular hex end on the short arm gives the ability to apply higher torque
- Removable lid and dove tail joints

Ball Point T-Handle Hex Drivers:

100 mm long:	2.5, 3, 4 mm
150 mm long:	5, 6, 7 mm
190 mm long:	8 mm

Item ID: **TTHEX7**

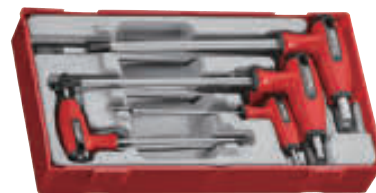

TT SERIES



7 Pieces mm

T-HANDLE HEX KEY SET TTI 7 PIECES

- Regular hex end on the short and long arms gives the ability to apply higher torque
- Removable lid and dove tail joints

T-Handle Hex Drivers:

100 mm long:	2.5, 3, 4 mm
150 mm long:	5, 6, 7 mm
190 mm long:	8 mm

Item ID: **TTHEX7S**



TT SERIES



7 Pieces AF

T-HANDLE BALL POINT HEX KEY SET AF TTI

- Ball point end on the long key end giving access at angles of up to 25°
- Regular hex end on the short and long arms gives the ability to apply higher torque
- Removable lid and dove tail joints

Ball Point T-Handle Hex Drivers:

100 mm long:	3/32", 1/8", 5/32"
150 mm long:	3/16", 7/32", 1/4"
190 mm long:	5/16"

Item ID: **TTHEX7AF**



TT SERIES



7 Pieces

T-HANDLE TX/TPX KEY SET TTI 7 PIECES

- TPX type on the long key end for tamper proof TX fastenings
- Regular TX end on the short arm giving the ability to apply higher torque
- Removable lid and dove tail joints

T-Handle TX Drivers:

100 mm long:	TX/TPX10, TX/TPX15, TX/TPX20
150 mm long:	TX/TPX25, TX/TPX27, TX/TPX30
190 mm long:	TX/TPX40

Item ID: **TTTX7**



TT SERIES



28 Pieces mm AF

BALL POINT HEX & TX KEY SET TTI 28 PIECES

- Includes a range of ball point keys covering metric and AF hex key & TX keys
- Removable lid and dove tail joints

Ball Point Hex & TX Keys:

1.5, 2, 2.5, 3, 4, 5, 6, 7, 8, 10 mm
5/64", 3/32", 1/8", 5/32", 3/16", 7/32", 1/4", 5/16", 3/8"
TX8, TX9, TX10, TX15, TX20, TX25, TX27, TX30, TX40

Item ID: **TTHT28**

PLIERS



TT SERIES



4 Pieces

PLIER SET VINYL GRIP TTI 4 PIECES

- Vinyl grip for easier use in pockets or tool pouches
- All the most commonly used pliers in one set

Pliers:

SIDE CUTTER	6" / 155 mm
COMBINATION	7" / 180 mm
LONG NOSE	8" / 200 mm
WATER PUMP	10" / 250 mm

Item ID: **TT440**



TT SERIES
1 2

8 Pieces

PLIER SET VINYL GRIP TT2 8 PIECES

- Vinyl grip for easier use in pockets or tool pouches
- All the most commonly used pliers in one set
- Supplied in the unique TengTools double width TC tray

Pliers:			
HEAVY DUTY SIDE CUTTER	6" / 160 mm	LONG NOSE	6" / 160 mm
	8" / 200 mm		8" / 200 mm
HIGH LEVERAGE COMBINATION	6" / 160 mm	WATER PUMP	7" / 180 mm
	8" / 200 mm		10" / 250 mm

Item ID: **TTD441**



TT SERIES
1 2

8 Pieces

TPR GRIP

PLIER SET TPR GRIP TT2 8 PIECES

- TPR grip for a more secure and comfortable grip
- All the most commonly used pliers in one set
- Supplied in the unique TengTools double width TC tray

Pliers:			
HEAVY DUTY SIDE CUTTER	6" / 160 mm	LONG NOSE	6" / 160 mm
	8" / 200 mm		8" / 200 mm
HIGH LEVERAGE COMBINATION	6" / 160 mm	WATER PUMP	7" / 180 mm
	8" / 200 mm		10" / 250 mm

Item ID: **TTD441-T**



TT SERIES
1

28 Pieces

TPR GRIP

PLIER SET TPR GRIP TTI 4 PIECES

- TPR grip for a more secure and comfortable grip
- All the most commonly used pliers in one set

Pliers:	
SIDE CUTTER	6" / 155 mm
COMBINATION	7" / 180 mm
LONG NOSE	8" / 200 mm
WATER PUMP	10" / 250 mm

Item ID: **TT440-T**



TT SERIES
x4

2 Pieces

PLIER & WRENCH SET TTX4 2 PIECES

- 2 tools for gripping even the most stubborn nuts and bolts
- Supplied in the unique TengTools drawer width TTX tray

Pliers:	
QUICK ACTION WATER PUMP	10" / 250 mm
Wrenches	
ALIGATOR ADJUSTABLE	8" / 200 mm

Item ID: **TTXMB02**



TT SERIES
1

4 Pieces

CIRCLIP PLIER SET 10-25 MM TTI 4 PIECES

- For use with inner and outer type circlips or snap rings
- 1.3mm tip and 10 to 25mm capacity
- Chrome vanadium construction
- Return spring for easier use
- Vinyl grip for easier use in pockets or tool pouches
- DIN5254/DIN5256

5" / 130 mm Circlip Pliers:		
STRAIGHT	INNER	12 - 25 mm
	OUTER	12 - 25 mm
BENT	INNER	12 - 25 mm
	OUTER	12 - 25 mm

Item ID: **TT474-5**



TT SERIES
1

4 Pieces

CIRCLIP PLIER SET 19-60 MM TTI 4 PIECES

- For use with inner and outer type circlips or snap rings
- 1.8mm tip and 19 to 60mm capacity
- Chrome vanadium construction
- Return spring for easier use
- Vinyl grip for easier use in pockets or tool pouches
- DIN5254 and DIN5256

7" / 175 mm Circlip Pliers:		
STRAIGHT	INNER	19 - 60 mm
	OUTER	19 - 60 mm
BENT	INNER	19 - 60 mm
	OUTER	19 - 60 mm

Item ID: **TT474-7**

NEW



TT SERIES
1

4 Pieces

CIRCLIP PLIER SET PRO 12-25 MM TTI 4 PIECES

- Invisible return spring for easier operation.
- For use with inner and outer type circlips or snap rings.
- 1.3mm bearing steel tip for heavy duty applications.
- Non slip tip angle enabling the ring to stock securely to the tip when compressing or expanding the circlip.
- 12 to 25mm capacity.
- Chrome vanadium construction.
- Vinyl grip for easier use in pockets of tool pouches
- DIN5254 and DIN5256

5" / 130 mm Circlip Pliers:		
STRAIGHT	INNER	12 - 25 mm
	OUTER	12 - 25 mm
BENT	INNER	12 - 25 mm
	OUTER	12 - 25 mm



Item ID: **TT474-5E**



TT SERIES
1

4 Pieces

CIRCLIP PLIER SET PRO 19-60 MM TTI 4 PIECES

- Invisible return spring for easier operation
- For use with inner and outer type circlips or snap rings
- 1.8mm bearing steel tips for heavy duty applications
- Non slip tip angle enabling the ring to stock securely to the tip when compressing or expanding the circlip
- 19 to 60mm capacity
- Chrome vanadium construction
- Return spring for easier use
- Vinyl grip for easier use in pockets or tool pouches
- DIN5254 and DIN5256

7" Circlip Pliers:		
STRAIGHT	INNER	19 - 60 mm
	OUTER	19 - 60 mm
BENT	INNER	19 - 60 mm
	OUTER	19 - 60 mm



Item ID: **TT474-7E**



TT SERIES
x4

4 Pieces

CIRCLIP PLIER SET 40-100 MM TTX4 4 PIECES

- For use with inner and outer type circlips or snap rings
- 2.3mm tip and 40 to 100mm capacity
- Chrome vanadium construction
- Return spring for easier use
- Vinyl grip for easier use in pockets or tool pouches
- DIN5254 and DIN5256

9" / 225 mm Circlip Pliers:		Capacity
STRAIGHT	INNER	40 - 100 mm
	OUTER	40 - 100 mm
BENT	INNER	40 - 100 mm
	OUTER	40 - 100 mm

Item ID: **TTX474-9**

NEW



TT SERIES
x4

4 Pieces

CIRCLIP PLIER SET PRO 40-100 MM TTX4

- Invisible return spring for easier operation.
- For use with inner and outer type circlips or snap rings.
- 2,3mm bearing steel tip for heavy duty applications.
- Non slip tip angle enabling the ring to stock securely to the tip when compressing or expanding the circlip.
- 40 to 100mm capacity.
- Chrome vanadium construction.
- Vinyl grip for easier use in pockets or tool pouches
- DIN5254 and DIN5256

9" / 225 mm Circlip Pliers:		Capacity
STRAIGHT	INNER	40 - 100 mm
	OUTER	40 - 100 mm
BENT	INNER	40 - 100 mm
	OUTER	40 - 100 mm



INVISIBLE RETURN SPRING

Item ID: **TTX474-9E**



TT SERIES
1

5 Pieces

POWER GRIP PLIER SET TTI 5 PIECES

- All the most commonly used power grip pliers in one set
- Self locking with release lever
- With locking nut on adjustment knob for pre-setting, ideal for repeated use
- Wire cutter and crimper function
- Chrome molybdenum

Power Grip Pliers:	
	4" / 100 mm
STANDARD ROUND JAW	7" / 180 mm
	10" / 250 mm
	4" / 100 mm
LONG NOSE	6" / 155 mm

Item ID: **TTVG05**



TT SERIES
x2

3 Pieces

POWER GRIP PLIER SET TTX2 3 PIECES

- The most commonly used power grip pliers in one set
- Self locking with release lever
- With locking nut on adjustment knob for pre-setting, ideal for repeated use
- Wire cutter and crimper function
- Chrome molybdenum

Power Grip Pliers:	
STANDARD ROUND JAW	4" / 100 mm
	4" / 100 mm
LONG NOSE	6" / 155 mm

Item ID: **TTZVG03**



TT SERIES
4

4 Pieces

POWER GRIP PLIER SET TT4 4 PIECES

- Includes all the most commonly used welding pliers in one set
- Supplied in the unique TengTools PS tray
- Designed to fit exactly in TengTools tool box drawers
- Can be used as a set on it's own or as part of the TengTools "Get Organised" system

Power Grip Pliers:	
LONG NOSE	6" / 155 mm
SHEET METAL GRIP	8" / 230 mm
WELDING GRIP	9" / 230 mm
C CLAMP PLIER	11" / 280 mm

Item ID: **TTPSPG**

INSULATED TOOLS



TT SERIES
1

6 Pieces

INSULATED SCREWDRIVER SET MIXED TTI

- Approved for live working up to 1,000 volts
- Integrated protective insulation with two colours to clearly indicate if there is any damage
- Designed and manufactured to DIN ISO 2380, DIN ISO 8764-1 and IEC 60900

1000V Insulated Screwdrivers:			
mm:	4 x 100	5.5 x 125	
mm:	PH1 x 80	PH2 x 100	
mm:	PZ1 x 80	PZ2 x 100	

Item ID: **TTV706N**



TT SERIES
1

7 Pieces

INSULATED SCREWDRIVER SET MIXED TTI

- Approved for live working up to 1,000 volts
- Integrated protective insulation with two colours to clearly indicate if there is any damage
- Designed and manufactured to DIN ISO 2380, DIN ISO 8764-1 and IEC 60900

1000V Insulated Screwdrivers:			
mm:	2.5 x 75	4 x 100	5.5 x 125
mm:	PH0 x 60	PH1 x 80	PH2 x 100
mm:	PZ2 x 100		

Item ID: **TTV907N**

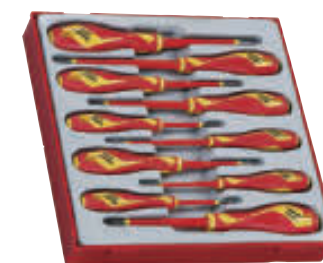

TT SERIES
2

10 Pieces

INSULATED SCREWDRIVER SET MIXED TT2

- Approved for live working up to 1,000 volts
- Integrated protective insulation with two colours to clearly indicate if there is any damage
- Designed and manufactured to DIN ISO 2380, DIN ISO 8764-1 and IEC 60900

1000V Insulated Screwdrivers:				
mm:	2.5 x 75	3 x 100	4 x 100	5.5 x 125
mm:	PH0 x 60	PH1 x 80	PH2 x 100	
mm:	PZ0 x 60	PZ1 x 80	PZ2 x 100	

Item ID: **TTDV910N**



TT SERIES



INSULATED SCREWDRIVER BLADE SET TTI

- Interchangeable blades for a wide range of tips in one set
- Approved for live working up to 1,000 volts
- Designed and manufactured to DIN ISO 2380, DIN ISO 8764-1 and IEC 60900

Insulated handles: 22x100mm, 37x122mm

1000V Insulated Screwdriver blades:

Reg mm:	3 x 70		
Slim mm:	4 x 100	5.5 x 80	6.5 x 100
Slim mm:	PH1 x 80	PH2 x 100	
Slim mm:	PZ1 x 80	PZ2 x 100	

Item ID: **TTV710N**



TT SERIES



INSULATED PLIER SET TTI 4 PIECES

- Approved for live working up to 1,000 volts
- TPR grip for a more secure and comfortable grip
- Designed and manufactured to DIN5745, DIN5746, DIN5749 and IEC 60900

1000V Insulated Pliers:

SIDE CUTTER	6" / 150 mm
LONG NOSE	8" / 200 mm
COMBINATION PLIERS	7" / 175 mm
WIRE STRIPPING PLIERS	6" / 155 mm

Item ID: **TTV440**



TT SERIES



1000V TORQUE SCREWDRIVER BLADE SET TTI

- Slim blades with reduced blade diameter for easier access to recessed screws and spring elements
- Approved for live working up to 1,000 volts
- Designed and manufactured to IEC 60900

Torque Screwdriver 1/4 in 1-5Nm 1000V

1000V Insulated Screwdriver blades:

Reg mm:	3 x 70		
Slim mm:	4 x 100	5.5 x 80	6.5 x 100
Slim mm:	PH1 x 80	PH2 x 100	
Slim mm:	PZ1 x 80	PZ2 x 100	

Item ID: **TTVSD09**



TT SERIES



INSULATED SOCKET SET 3/8" DRIVE TTI

- Approved for live working up to 1,000 volts
- 6 point single hexagon socket for a better grip
- Integrated protective insulation with two colours to clearly indicate if there is any damage to the insulation
- Designed and manufactured to DIN, ISO and IEC 60900

3/8" Drive Insulated Ratchet

6" Insulated Extension bar

Regular 6 point Insulated sockets:

mm:	8	9	10	11	12	13
	14	15	16	17	18	19

Item ID: **TTV3814**

CUTTING TOOLS



TT SERIES



CUTTING TOOL SET TT2 5 PIECES

- Includes high leverage tin snips for straight, left and right cutting
- Utility knife with retractable blade and ergonomic grip
- High carbon stainless steel blade industrial scissors
- Heavy duty cable cutters with compound leverage for easier cutting

Cutting Tools:

Tin snips (straight/left & straight/right), utility knife, scissors, heavy duty cable cutters

Item ID: **TTDCT05**



TT SERIES



KNIFE SET TTI 40 PIECES

- Includes a selection of different knives to suit all types of use
- Spare blades included for each type of knife

Knives:

Utility knife with auto load function, folding universal knife, folding mini utility knife, hobby knife with 9mm blade, hobby knife with 18mm blade

Spare blades:

5 x Regular knife blades, 10 x Mini knife blades, 10 x 9mm Snap off blades, 10 x 18mm Snap off blades

Item ID: **TTK40**



TT SERIES



DRILL BIT SET 1.0-13.0 MM TTI 28 PIECES

- Standard drill bits for use with steel and cast iron, etc.
- Spiral angle of 28° for clean cutting
- Split point angle of 118° for better positioning
- Shank the same diameter as the tip
- Designed and manufactured to DIN338

Fully Ground Drill Bits:

1.0 (x3), 1.5 (x3), 2.0 (x2), 2.5 (x2), 3.0, 3.5, 4.0, 4.5, 5.0, 5.5, 6.0, 6.5, 7.0, 7.5, 8.0, 8.5, 9.0, 10.0, 10.5, 11.0, 12.0, 13.0

Item ID: **TTDB28**



TT SERIES



TAP AND DIE SET TTI 17 PIECES

- Suitable for repairing damaged threads from M3 to M12
- Tap and die holders included
- A thread gauge is included to help identify the pitch of the thread

Metric dies:

3x0.5 mm, 4x0.7 mm, 5x0.8 mm, 6x1.0 mm, 8x1.25 mm, 10x1.5 mm, 12x1.75 mm

Metric taps:

3mm, 4mm, 5mm, 6mm, 8mm, 10mm, 12mm

Accessories:

Tap handle (capacity 3 to 12mm), die handle with adjustment screw (capacity 3 to 12mm), screw pitch gauge

Item ID: **TTTD17**



TT SERIES
2

34 Pieces

TAP AND DIE SET TT2 34 PIECES

- Designed for the repair of damaged threads covering M3 to M12
- Includes taps and dies with interchangeable chucks
- Screw extractors also included to give a complete set for repairing threads
- Various accessories including drill bits, a screw pitch gauge and mini palm ratchet

Metric dies:

3x0.5 mm, 4x0.7 mm, 5x0.8 mm, 6x1.0 mm, 8x1.25 mm, 10x1.5 mm, 12x1.75 mm

Metric taps:

3mm, 4mm, 5mm, 6mm, 8mm, 10mm, 12mm

Fully ground drill bits:

2.5, 3.3, 4.2, 5.0, 6.8, 8.5, 10.5 mm

Screw extractors:

1/8", 3/16", 15/64", 5/16", 3/8"

Accessories:

Screw pitch gauge, mini screwdriver hex (2.5x40mm), 1/4" extension bar, 3/8" F:1/4" M adaptor, 1/4" mini palm ratchet, 1/4" interchangeable die chuck, 1/4" tap chuck (x2 - M3-M8, M5-M12)

Item ID: **TTD34**



TT SERIES
1

12 Pieces

NEEDLE FILE SET TTI 12 PIECES

- All the most commonly used types of needle file in one handy set
- Removable lid and dove tail joints

Needle Files:

Hand, half round, three square, square, round, flat point, knife type, barrette, crossing, oval, feather edge, round edge flat

Item ID: **TTNF12**



TT SERIES
x4

5 Pieces

HAND FILE SET TTX4 5 PIECES

- 10" high carbon steel hand files
- Bi-material handle for a more comfortable grip
- 2nd cut to create a diamond pattern cutting surface for smoother filing
- Cut on both edges of the flat files for filing grooves, etc

10" Files:

Flat, Hand, Half Round, Round, Three square

Item ID: **TTXF05**

MEASURING TOOLS



TT SERIES
1

4 Pieces

MEASURING TOOL SET TTI 4 PIECES

- Ideal for engineers and technicians
- Includes a 4 function vernier caliper, steel rule, scriber and base square

Measuring Tools:

Vernier Caliper	150mm / 6"
Steel Rule	150 mm
Base Square	100 x 70 mm
Scriber	150 mm

Item ID: **TTBM**



TT SERIES
2

4 Pieces

MEASURING TOOL SET TT2 4 PIECES

- Ideal for mechanics and technicians
- Includes a 4 function digital caliper, multimeter, thread gauge and feeler gauge sets

Measuring Tools:

Digital Caliper	150mm / 6"
Thread Gauge Set	0.25-6.0mm, 4-42 UNC
Feeler Gauge Set	100mm Length, 0.05-1.0mm
Multimeter	AC, DC, voltage, current, resistance, temperature, CAT II 250V

Item ID: **TTDCM**

AUTO TOOLS



TT SERIES
1

4 Pieces

HOOK & PICK SET TTI 4 PIECES

- 4 piece hook and pick set
- Includes hooks, awls and picks for detail work and scribing
- Ideal for cleaning components and retrieving lost items in hard to reach places

Hooks & Picks:

Straight Awl, 35° Hook tool, 90° Hook Tool, 125° Hook Tool

Item ID: **TTMDP**



TT SERIES
1

4 Pieces

SCRAPER SET TTI 4 PIECES

- Includes a gasket scraper, an awl and two hook tools
- Ideal for cleaning, scraping and removing unwanted residue

Scrapers:

Gasket scraper 22mm wide blade, total length 245mm

Hooks & awl Curved hook, 90° hook and awl

Item ID: **TTSR04**



TT SERIES



3 Pieces

HOSE CLAMP SET TTI 3 PIECES

- Range of sizes giving a capacity of 6 to 57mm (1/4" to 2 1/4")
- Specially designed jaws prevent internal hoses from damage when clamping
- Lightweight and easy to use
- Non conductive

Hose clamps:

For hoses: 1/4"-3/4", 1/4"-1-1/4", 3/4"-2-1/4"

Item ID: **TTHC03**



TT SERIES



7 Pieces

3/8"

1/2"

AUTOMOTIVE SOCKET SET TTI 7 PIECES

- All the most commonly used specialist automotive sockets in one handy set
- Includes sockets for removing and installing injectors, oil sender and vacuum switches as well as various oxygen sensors

3/8" Drive Sockets:

22 mm	Length: 90 mm	Oxygen sensor socket for Mitsubishi, Nissan, Opel, Vauxhall & VW
7/8"	Length: 80 mm	Vacuum switch socket
1-11/16"	Length: 74 mm	Oil sender socket
7/8"	Length: 30 mm	Offset oxygen sensor socket

1/2" Drive Sockets:

29 mm	Length: 90 mm	Oxygen sensor socket for GM
27 mm	Length: 85 mm	Injector socket for M24
7/8"	Length: 50 mm	Heated oxygen sensor socket

Item ID: **TTSS07**



TT SERIES



16 Pieces

3/8"

OIL SERVICE SET TTI 16 PIECES

- All the tools normally required for an oil service included in one handy set
- Includes an oil filter wrench, drain plug set, spark plug sockets, metric feeler gauge set and a 3 in 1 inspection tool with magnetic pick up

3/8" Drive Accessories:

3" & 10" wobble extensions, 1/2" F x 3/8" Male T-bar adaptor

3/8" Drive Sockets:

21mm regular 6 point socket, 16 & 21mm spark plug sockets

Drain Plug Set:

Bar, 5/16" hex x 3/8" hex, 11mm square x 12mm hex, 17mm hex x 1/2" hex, 8mm square x 3/8" square, 13mm square x 14mm hex, 8mm hex x 10mm hex

Service Tools:

Strap type oil filter wrench, 3 in 1 telescopic inspection tool, 20 piece feeler gauge set (0.05 mm - 1.0 mm)

Item ID: **TTOS16**



TT SERIES



5 Pieces

3/8"

mm

3/8" T BAR SPARK PLUG SOCKET SET TTX4

- Magnet spark plug sockets
- 3/8" drive extra long swivelling magnetic spark plug sockets for use in hard to reach places
- T bar with the TengTools T-HD handle for more comfortable use

2 Piece T-bar handle

3/8" Drive extra long swivelling spark plug sockets:

mm: 14 16 21

Item ID: **TTXTB05**



TT SERIES



9 Pieces

3/8"

mm

3/8" LONG T BAR SOCKET SET TTX4 9 PIECES

- Extra long socket set
- 3/8" drive extra long sockets for use in hard to reach places
- T bar with the TengTools T-HD handle for more comfortable use

2 Piece T-bar handle

3/8" Drive extra long sockets:

mm: 8 10 12 13 14 17 19

Item ID: **TTXTB09**



TT SERIES



10 Pieces

FLARING TOOL SET TTI 10 PIECES

- Suitable for copper, brass and thin walled aluminium tubing
- 45° tube press flare pipes from 3/16" to 5/8" (4 to 14mm) diameter
- Heavy duty pipe cutter included for cutting pipes up to 32mm (1-1/4") diameter

2 piece double flaring tool set

Pipe Cutter: 3-32 mm (1/8"-1-1/4")

Adaptors: 4, 4.75 (3/16"), 6 (1/4"), 8 (5/16"), 10, 12, 14 mm

Item ID: **TTTF10**



TT SERIES



5 Pieces

BODYWORK HAMMER SET TT4 5 PIECES

- A selection of hammers for use in the automotive body shop or metal working area

Hammers:

Dead blow hammers with 35 and 55mm diameter heads, crown face hammers with straight pein, pick heads and square milled face

Item ID: **TTPSAD**

SERVICE TOOLS



TT SERIES



4 Pieces

PULLER SET TTI 4 PIECES

- Three legged combination puller
- Supplied with an extra yoke for switching to two legged pulling
- Reversible legs for internal or external grip

Pullers:

Combination twin/triple 6" leg puller with 4" capacity

Item ID: **TT804**



TT SERIES
1

11 Pieces 1/2"

EXTRACTOR & NUT SPLITTER SET TTI

- Includes screw extractors, stud extractors and nut splitters
- Ideal for use with broken nuts, bolts, studs or screws

1/2" Drive Stud Extractors:

6, 8, 10, 12 mm

Screw Extractors:

7/64", 9/64", 5/32", 1/4", 19/64"

Nut Splitters:

5 to 20mm, 14 to 27mm

Item ID: **TTSN11**



TT SERIES
1

18 Pieces 3/8" 1/2"

STUD EXTRACTOR SET TTI 18 PIECES

- Includes all the most commonly used sizes from 6mm (5/16") to 25mm (1")
- Designed for removing rounded or damaged bolt heads or nuts
- 4mm parallel pin punch included for clearing debris from the extractors
- Chrome vanadium satin finish
- Designed and manufactured to DIN3120/3124 and ISO2725

3/8" Drive Stud Extractors:

6 (5/16"), 8, 10 (3/8"), 11 (7/16"), 12, 13 (1/2"), 14 (9/16"), 16 (5/8"), 17 mm

1/2" Drive Stud Extractors:

19, 21, 22, 24, 25 mm

3/4", 13/16", 7/8", 15/16", 1"

Parallel Pin Punch:

4mm (150mm length)

Item ID: **TTBE18**



TT SERIES
x4

3 Pieces

PRY BAR SET ROLL/HEEL TTX4 3 PIECES

- Includes roll/heel bars in three sizes to suit different applications

Roll heel bars:

12", 16", 20"

Item ID: **TTXPB3**



TT SERIES
x4

3 Pieces

PRY BAR SET TTX4 3 PIECES

- Includes pry bars in three sizes and shapes to suit different applications

Roll heel bars:

12", 18", 22"

Item ID: **TTXPB3A**



TT SERIES
1

121 Pieces

CRIMPING PLIER SET TTI 121 PIECES

- Multi function 9" crimping plier and wire stripper
- Use on insulated, non insulated terminals and connectors
- Wire stripping capacity from 0.75 to 6mm
- Cutting function for M2.5 to M5 bolt sizes
- Includes a range of insulated, non insulated terminals and connectors

Crimping Tool:

Multi function CP50 crimping tool

Terminals/connectors:

Red #6 ring terminals x 20
Blue #8 spade terminals x 20
Red butt connectors x 20
Blue butt connectors x 20
Blue 6.3x0.8mm female connectors x 20
Blue 6.3x0.8mm male connectors x 20

Item ID: **TTCP121**



TT SERIES
1

4 Pieces

CRIMPING PLIER SET TTI 4 PIECES

- Interchangeable ratchet crimping tool
- Automatic locking mechanism to ensure a consistent and correct crimping action
- Includes a range of interchangeable heads
- Use on insulated, non insulated terminals and connectors

Crimping Tool:

Changeable ratchet crimping tool for insulated terminals 22-10 AWG

Terminals/connectors:

Die for non-insulated open barrel connector, commercial type 22-12 AWG (0.324 square mm - 3.31 square mm)

Die for non-insulated terminals 22-8 AWG (0.3 square mm - 8 square mm)

Other Tools:

Hex key wrench 2.5mm

Item ID: **TTCP04**



TT SERIES
1

6 Pieces

PIPE CUTTER SET TTI 6 PIECES

- For cutting plastic, copper and brass pipes from 3 to 22mm diameter
- Deburring tool included for tidying up any sharp edges

Pipe Cutters:

Capacity: 10, 12, 15, 22 mm

Adjustable pipe cutter capacity: 3-22 mm

Accessories:

Deburring tool

Item ID: **TTTC06**



TT SERIES
1

81 Pieces

RIVET GUN SET TTI 81 PIECES

- Aluminium alloy, forged steel upper handle with heat treated jaws for durability
- Suitable for aluminium and steel rivets from 2.4 to 4.8mm and stainless steel rivets up to 4.0mm
- Includes 80 assorted rivets in individual storage compartments

Hand rivetter:
4 nozzles to suit aluminium/steel blind rivets (2.4, 3.2, 4.0, 4.8 mm)
Aluminium rivets:
2.4mm (3/32") x 20 black
3.2mm (1/8") x 20 black
4.0mm (5/32") x 20 black
4.8mm (3/16") x 20 black
Accessories:
Nozzle wrench

Item ID: **TTHR81**



TT SERIES
1

81 Pieces

NUTSERT GUN SET TTI 81 PIECES

- Aluminium alloy, forged steel upper handle with heat treated jaws for durability
- Quick change, lockable threaded mandrels
- Mandrels for M3, M4, M5 and M6 included
- Includes 80 assorted nutserts in individual storage compartments

Nutsert Tool:
4 quick change mandrels (M3 x 0.5, M4 x 0.7, M5 x 0.8, M6 x 1.0)
Aluminium rivets:
M3 x 20 pieces
M4 x 20 pieces
M5 x 20 pieces
M6 x 20 pieces
Accessories:
Nose piece wrench

Item ID: **TTNR81**



TT SERIES
1

3 Pieces

INSPECTION SET TTI 3 PIECES

- Ideal set for finding and retrieving lost nuts and bolts, etc.
- An extending mirror and magnifier with adjustable heads
- The extending magnetic pick up tool helps retrieve items up to 4,500g
- Mirror & magnifying glass extend to 850mm and the magnet extends to 760mm

Inspection Tools:
Telescopic magnifying glass
Telescopic inspection mirror
Telescopic magnetic pick up tool

Item ID: **TTM03**



TT SERIES
1

8 Pieces

INSPECTION SET TTI 8 PIECES

- Ideal set for finding and retrieving lost nuts and bolts, etc.
- Includes telescopic magnetic pick up, magnifying glass, inspection mirror, a flexible claw pick up and even an LED torch

Inspection Tools:
LED flashlight
Flexible magnetic pick up, length 310mm
Telescopic magnetic pick up, length 160-480mm
38mm magnifying glass 1:3 with magnetic adaptor
38mm inspection mirror with magnetic adaptor
230mm flexible claw pick up tool
Batteries AAA (2 pieces)

Item ID: **TTM08**



TT SERIES
1

9 Pieces

PUNSCH & CHISEL SET TTI 9 PIECES

- Flat cold chisel made from chrome molybdenum
- Pin punches made from chrome molybdenum

Punches:
Centre Length: 150 mm 5 mm
Parallel Length: 150 mm 3, 4, 5, 6, 7, 8 mm
Flat cold chisels:
150 mm Width: 19 mm
200 mm Width: 25 mm

Item ID: **TTPC09**

AIR TOOLS



TT SERIES
2

13 Pieces

1/2"

1/2" AIR IMPACT WRENCH SET TT2 13 PIECES

- Compact and lightweight 1/2" drive impact wrench
- For use in confined spaces
- Supplied with stubby 1/2" drive impact sockets
- Supplied in the unique TengTools tray to be used within the Get Organised System

Impact Sockets - 1/2" Stubby:
10, 12, 13, 14, 15, 16, 17, 18, 19, 21, 22, 24 mm

Compact Impact Wrench Specification:

Square drive	1/2"
Bolt capacity	mm M16
Free speed	rpm 8,000
Max torque (3 steps)	Nm 285/380/680
Max torque (3 steps)	ft-lb 210/280/501
Max reverse torque	Nm 770
Max reverse torque	ft-lb 568
Hammer mechanism	type Jumbo hammer
Sound level *	dB 102
Vibration **	m/s ² 7.5
Minimum hose size	inch 3/8"
Air inlet	inch 1/4"
Air consumption at 100% int.	l/min 121
Air consumption at 100% int.	cfm 4.23
Air consumption at 15% int.	l/min 18
Air consumption at 15% int.	cfm 0.6
Length	mm 113
Weight	kg 1.3

Item ID: **TTDAWM13M**

FOAM SERIES

THE ULTIMATE CHOICE IN TOOL ORGANISATION

The Foam Series offers the ultimate tool organisation. Each tool has its own place with its description imprinted in the 3-coloured foam. The contrast colours makes it easy to identify tools and see when a tool is missing. The high quality foam stays soft and flexible even in cold environments and gives the tool kit a premium look.



STORAGE TRAYS



STORAGE TRAY FOAM1 7 COMPARTMENTS

- Storage tray with 7 compartments
- Three colour pre-cut EVA foam
- Ideal for storing small items as part of a tool kit or work station
- Removable lid and dove tail joints

Item ID: **TEA01**



STORAGE TRAY FOAM1 2 COMPARTMENTS

- Storage tray with 2 compartments
- Three colour pre-cut EVA foam
- Ideal for storing small items as part of a tool kit or work station
- Removable lid and dove tail joints

Item ID: **TEA02**



STORAGE TRAY FOAM2 4 COMPARTMENTS

- Storage tray with 4 compartments
- Three colour pre-cut EVA foam
- Ideal for storing small items as part of a tool kit or work station
- Removable lid and dove tail joints

Item ID: **TE000**



STORAGE TRAY FOAM2 8 COMPARTMENTS

- Storage tray with 8 compartments
- Three colour pre-cut EVA foam
- Ideal for storing small items as part of a tool kit or work station
- Removable lid and dove tail joints

Item ID: **TED01**

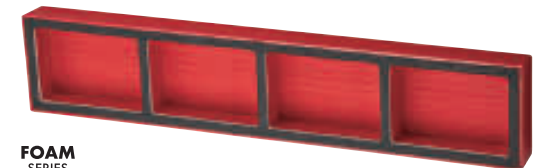

STORAGE TRAY FOAMX4 4 COMPARTMENTS

- Storage tray with 4 compartments
- Three colour pre-cut EVA foam
- Ideal for storing small items as part of a tool kit or work station

Item ID: **TEX02**



STORAGE TRAY FOAMX2 3 COMPARTMENTS

- Storage tray with 3 compartments
- Three colour pre-cut EVA foam
- Ideal for storing small items as part of a tool kit or work station

Item ID: **TEZ01**



GENERAL TOOL KITS



FOAM SERIES
3

7 Pieces

GENERAL TOOL SET FOAM3 7 PIECES

- Includes pliers, adjustable wrench, knife, tin snips and a claw hammer
- Tools are held in place using three colour pre-cut EVA foam
- Designed to fit exactly in the TengTools TC-SC service case

General Tools:	
TPR Grip Pliers:	6" side cutters, 8" long nose pliers, 10" quick set water pump pliers
Wrenches	8" wide jaw adjustable wrench
Cutting Tools:	Utility knife, straight cut high leverage tin snips
Hammers:	16 oz claw hammer

Item ID: TEFMB7



FOAM SERIES
3

7 Pieces

GENERAL TOOL SET BP FOAM3 7 PIECES

- Includes pliers, adjustable wrench, knife, tin snips and a ball peen hammer
- Tools are held in place using three colour pre-cut EVA foam
- Designed to fit exactly in the TengTools TC-SC service case

General Tools:	
TPR Grip Pliers:	6" side cutters, 8" long nose pliers, 10" quick set water pump pliers
Wrenches	8" wide jaw adjustable wrench
Cutting Tools:	Utility knife, straight cut high leverage tin snips
Hammers:	16 oz ball peen hammer

Item ID: TEFMBP7



FOAM SERIES
4x4

25 Pieces

GENERAL TOOL SET FOAM4X4 25 PIECES

- Includes measuring, striking and cutting tools as well as all the most commonly used pliers
- Tools are held in place using three colour pre-cut EVA foam
- Designed to fit exactly in the larger TengTools tool box drawers

General Tools:	
Cutting Tools:	12" hacksaw, craft knife with 10 spare 18mm snap off blades
Striking Tools:	Soft face hammer, 500g engineers style hammer, parallel pin punches (3, 4, 5, 6, 7, 8mm)
Pliers:	6" heavy duty side cutters, 7" high leverage combination pliers, 6" long nose pliers, 10" water pump pliers
Measuring Tools:	3 meter measuring tape

Item ID: TTEPS25



FOAM SERIES
4x4

15 Pieces

GENERAL TOOL SET FOAM4X4 15 PIECES

- Includes hack saw, measuring tape, parallel pin punches well as a range of pliers with TPR grip
- Tools are held in place using three colour pre-cut EVA foam
- Designed to fit exactly in the larger TengTools tool box drawers

General Tools:	
General Tools:	12" hacksaw, 3M measuring tape, Parallel Pin Punch Set
TPR Grip Pliers:	8" heavy duty side cutters, 8" heavy duty combination pliers, 8" long nose pliers, 10" water pump pliers

Item ID: TTEPS15



FOAM SERIES
4x4

27 Pieces

GENERAL TOOL SET FOAM4X4 12 PIECES

- Includes measuring, striking and cutting tools as well as adjustable wrenches
- Tools are held in place using three colour pre-cut EVA foam
- Designed to fit exactly in the larger TengTools tool box drawers

General Tools:	
Cutting Tools:	12" hacksaw, craft knife with 10 spare 18mm snap off blades
Striking Tools:	800gm engineers hammer, soft face hammer, cold chisels (150x18mm, 200x25mm), 150x5mm centre punch, parallel pin punches (3, 4, 5, 6, 7, 8mm)
Wrenches	6" and 10" adjustable wrenches
Measuring Tools:	3 meter measuring tape, 200mm steel rule

Item ID: TTEPS12



FOAM SERIES
4x4
28 Pieces

GENERAL TOOL SET FOAM4X4 28 PIECES

- Includes combination spanners, screwdrivers, hex keys, an adjustable wrench and a claw pick up tool
- Tools are held in place using three colour pre-cut EVA foam
- Designed to fit exactly in the larger TengTools tool box drawers
- Designed and manufactured to DIN and ISO standards

Combination Spanners:	
8, 10, 11, 12, 13, 14, 15, 16, 17, 18, 19 mm	
General Tools:	
Wrenches	8" wide jaw adjustable
Ball point hex keys:	1.5, 2, 2.5, 3, 4, 5, 6, 8, 10 mm
Accessories:	600mm claw pick up tool
Screwdrivers:	3.5x75 mm PH1x75 mm PZ1x75 mm 5.5x150 mm PH2x100 mm PZ2x100 mm

Item ID: **TTESP28**



FOAM SERIES
4x4
17 Pieces

GENERAL TOOL SET FOAM4X4 17 PIECES

- Includes a 1/2" drive torque wrench, hex and TX keys and a selection of inspection tools
- Tools are held in place using three colour pre-cut EVA foam
- Designed to fit exactly in the larger TengTools tool box drawers

T Handle Hex Keys:	
	2.5, 3, 4, 5, 6, 7, 8 mm
Hex & TX Keys:	
	1.5, 2, 2.5, 3, 4, 5, 6, 7, 8, 10 mm
	TX8, TX9, TX10, TX15, TX20, TX25, TX27, TX30, TX40
Fold Up Key Set:	
	4, 5, 6mm Hex, TX25, TX30, 5.5mm Flat, PH1, PZ2
General Tools:	
Torque Wrench:	1/2" drive, Range: 40-200Nm
Inspection Tools:	Magnifying glass & mirror (telescopic with extension up to 85cm), LED torch, Hook and pick set
Pick Up Tools	Magnetic pick up, Aluminium handle with interchangeable awl, Hook tools: 45° and 90°

Item ID: **TTEX17**

SOCKET SETS



FOAM SERIES
1
87 Pieces 1/4" mm AF

1/4" SOCKET & BITS SET FOAM1 87 PIECES

- Gearless palm ratchet, accessories and a bi-flex wrench
- 1/4" drive regular 6 point sockets in metric and AF
- 1/4" drive deep 6 point sockets
- A selection of 25mm long bits

Gearless palm ratchet, 3" extension bar, 1/4"M x 1/4"Hex adaptor, Bi Flex wrench	
6 point sockets:	
	Reg mm: 5.5 6 7 8 9 10
	11 12 13
	Reg AF: 1/4" 5/16" 3/8"
	Deep mm: 6 7 8 9 10 11 12 13
1/4" Hex bits: Length 25mm	
	3.5, 4, 4.5, 5.5 (x2), 6.5, 8 PZ1 (x3), PZ2 (x6), PZ3
	PH1 (x3), PH2 (x6), PH3 2, 3, 4, 5, 6, 8 mm
	TX6, TX7, TX8, TX9, TX10, TX15, TX20(x3), TX25(x3), TX27, TX30, TX40
	TPX10, TPX15, TPX20 (x2), TPX25 (x2), TPX27, TPX30, TPX40
	ROBI, 2, 3 PH2G

Item ID: **TEA1487**



FOAM SERIES
2
89 Pieces 1/4" mm

1/4" SOCKET SET 6 PT FOAM2 89 PIECES

- 1/4" drive regular and deep sockets
- A comprehensive range of 1/4" hex drive 25mm bits
- Supplied in the unique TengTools double width TC tray
- Tools are held in place using three colour pre-cut EVA foam clearly showing where each tool belongs
- Designed and manufactured to DIN and ISO standards

72 Teeth ratchet, Universal Joint, Spinner handle, 2" & 4" Extension bars	
Coupler adaptor, 3/8"F x 1/4"M T-bar adaptor, 1/4"M x 1/4" Hex adaptor	
6 point sockets:	
	Reg mm: 4 5 5.5 6 7 8 9
	10 11 12 13
	Deep mm: 4 5 5.5 6 7 8 9
	10 12 13
1/4" drive bit sockets:	
	mm: 4 5.5 7
	TX: 10 15 20 25 27 30 40
	PZ: 1 2 3
	PH: 0 1 2 3
1/4" Hex bits:	
	TX8, TX10, TX15, TX20, TX25, TX27, TX30
	TPX10, TPX15, TPX20, TPX25, TPX27, TPX30, TPX40
	PZ0, PZ1, PZ2, PZ3 PH0, PH1, PH2, PH3, PH4
	3, 4, 5, 6, 8, 10 1/8, 9/64, 5/32, 3/16, 1/4, 5/16
	3, 4, 5.5, 7 XZN: 5, 6

Item ID: **TED1489**



FOAM SERIES

2

36 Pieces 3/8" mm

3/8" SOCKET SET 6 PT FOAM2 36 PIECES

- 3/8" drive regular length sockets
- A range of 3/8" drive bits sockets covering hex and TX sizes
- Tools are held in place using three colour pre-cut EVA foam clearly showing where each tool belongs
- Designed and manufactured to DIN and ISO standards

72 Teeth ratchet, Universal Joint, 3" Wobble extension bar,	
1/2" F x 3/8" M T-bar adaptor, 10" Spinner handle	
Regular 6 point sockets:	
mm:	8 9 10 11 12 13 14 15 16 17 18 19 22
3/8" Drive bit sockets:	
TX:	10 15 20 25 27 30 40 45 50
mm:	3 4 5 5.5 6 7 8 10 12

Item ID: **TED3836**



FOAM SERIES

2

27 Pieces 1/2" mm

1/2" SOCKET SET 12 PT FOAM2 27 PIECES

- 1/2" drive regular and deep sockets
- Supplied in the unique TengTools double width TC tray
- Tools are held in place using three colour pre-cut EVA foam clearly showing where each tool belongs
- Designed and manufactured to DIN and ISO standards

72 Teeth ratchet, 2 1/2" & 6" Extension bars	
Universal joint, 3/8" F x 1/2" M T-bar adaptor	
12 point sockets:	
Reg mm:	10 11 12 13 14 15 16 17 18 19 22 24
Deep mm:	10 11 12 13 14 15 16 17 18 19

Item ID: **TED1227**



FOAM SERIES

4x4

63 Pieces 1/2" mm

1/2" SOCKET SET 12 PT FOAM4X4 63 PIECES

- 1/2" drive regular and deep 12 point bi-hexagon sockets
- Tools are held in place using three colour pre-cut EVA foam clearly showing where each tool belongs
- Designed to fit exactly in the larger TengTools tool box drawers
- Can be used as a set on it's own or as part of the TengTools "Get Organised" system
- Designed and manufactured to DIN and ISO standards

72 Teeth ratchet, 2 1/2", 5", 6" & 20" Extension bars, 3", 6" & 10" Wobble extension bars	
Universal joint, 1/2" F x 3/8" M adaptor, 1/2" F x 3/4" M adaptor	
Coupler adaptors for 5/16", 10mm & 12mm bits, Flex head adaptor	
12 point sockets:	
Reg mm:	8 9 10 11 12 13 14 15 16 17 18 19 20 21 22 24 25 26 27 28 29 30 32 34
Deep mm:	10 11 12 13 14 15 16 17 18 19 20 21 22 24 27 30 32 36

Item ID: **TTESK63**



FOAM SERIES

x4

13 Pieces

EXTENSION BARS SET FOAMX4 13 PIECES

- Includes a selection of long and wobble extension bars
- TengTools T-HD handle included for a more comfortable grip
- Tools are held in place using three colour pre-cut EVA foam clearly showing where each tool belong
- Designed and manufactured to DIN and ISO standards

1/4" Drive	6" & 12" Extension bars, Universal joint
3/8" Drive	3" Wobble extension bar, 20" Extension bar, Universal joint, 3/8" F x 1/4" M T-bar adaptor
1/2" Drive	3" Wobble extension bar, 20" Extension bar, Universal joint
T-handle grip, 2mm & 2.5mm Mini Hex Screwdrivers	

Item ID: **TEXEXT13**



FOAM SERIES

x4

3 Pieces 3/4"

3/4" RATCHET & ACCESSORIES SET FOAMX4

- Quick release and twist reverse action for easier use
- Sliding T-bar and 16" (400mm) extension also included
- Tools are held in place using three colour pre-cut EVA foam clearly showing where each tool belong
- Designed and manufactured to DIN and ISO standards

Quick release 72 teeth ratchet, 400mm Extension bar	
Sliding T-bar	

Item ID: **TEX3403**



FOAM SERIES
x4

10 Pieces 3/4" mm

3/4" SOCKET SET 6 PT FOAMX4 10 PIECES

- Chrome vanadium
- Satin finish for a better grip when handling the sockets
- 6 point single hexagon sockets for a better grip
- Tools are held in place using three colour pre-cut EVA foam clearly showing where each tool belongs
- Designed and manufactured to DIN3120/3124

Regular 6 point sockets:						
mm:	22	24	27	30	32	36
	38	41	46	50		

Item ID: **TEX3410**



FOAM SERIES
4x4

32 Pieces 3/4" mm AF

3/4" SOCKET SET FOAM4X4 32 PIECES

- 3/4" drive regular sockets
- With safety locking system to avoid tools being dropped
- Tools are held in place using three colour pre-cut EVA foam clearly showing where each tool belongs
- Can be used as a set on it's own or as part of the TengTools "Get Organised" system
- Designed and manufactured to DIN and ISO standards

Quick release 72 teeth ratchet, 400mm Extension bar						
Sliding T-bar, 19" Flex handle						
Regular 6 point sockets:						
mm:	19	21	22	24	27	30
	32	33	34	36	38	41
	46	50				
Regular 12 point sockets:						
AF:	7/8	15/16	1	1-1/16	1-1/8	1-3/16
	1-1/4	1-5/16	1-3/8	1-7/16	1-1/2	1-5/8
	1-3/4	1-7/8				

Item ID: **TTESK32**

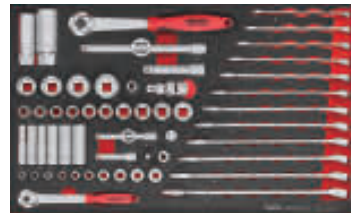

FOAM SERIES
3

57 Pieces 1/4" 3/8" mm

SPANNER & SOCKET SET FOAM3 57 PIECES

- Spanner and socket set
- Tools are held in place using three colour pre-cut EVA foam clearly showing where each tool belongs
- Designed to fit exactly in the TengTools TC-SC service case
- Can be used as a set on it's own or as part of the TengTools "Get Organised" system
- Designed and manufactured to DIN and ISO standards

1/4" Drive	72 Teeth ratchet, 2" & 3" extension bars, 3/8"F x 1/4"M adaptor, 1/4"Hex x 1/4"M adaptor, Coupler adaptor, Universal joint
3/8" Drive	72 Teeth ratchet, 3" & 6" Extension bars, 1/2"F x 3/8"M adaptor, Coupler adaptor, Universal joint
1/4" Drive 6 point sockets:	
Reg mm:	4 5 5.5 6 7
	8 10 11 12 13
Deep mm:	
	6 7 8 10 12 13
3/8" Drive 6 point sockets:	
Reg mm:	8 9 10 11 12 13 14 15 16
	17 18 19 21 22
Spark plug sockets mm:	16 21
Combination Spanners:	8, 9, 10, 11, 12, 13, 14, 15, 16, 17, 18, 19 mm

Item ID: **TEFSK57**



FOAM SERIES
4x4

86 Pieces 1/4" 3/8" mm

1/4" & 3/8" SOCKET SET FOAM4X4 86 PIECES

- Includes 72 teeth quick release, twist reverse ratchets
- Speed brace for quickly transporting nuts and bolts
- A selection of extension bars and accessories
- Tools are held in place using three colour pre-cut EVA foam clearly showing where each tool belongs
- Can be used as a set on it's own or as part of the TengTools "Get Organised" system
- Designed and manufactured to DIN and ISO standards

1/4" Drive	72 Teeth ratchet, 6" Spinner handle, Universal joint, Coupler adaptor, 2", 3", 4", 6" & 12" Extension bars, 1/4"F x 3/8"M adaptor, Sliding T-bar, T-bar handle adaptor
3/8" Drive	72 Teeth ratchet, Speed brace, Spinner handle, Universal Joint, 3", 5", 6", 10" & 20" Extension bars, 3/8"F x 1/4"M adaptor, 3/8"F x 1/2"M adaptor, Coupler adaptor
1/4" Drive 6 point sockets:	
Reg mm:	4 4.5 5 5.5 6 7 8 9 10
	11 12 13
Deep mm:	
	4 5 5.5 6 7 8 9 10 11
	12 13
3/8" Drive 6 point sockets:	
Reg mm:	7 8 9 10 11 12 13 14 15
	16 17 18 19 20 21 22
Deep mm:	
	7 8 9 10 11 12 13 14 15
	16 17 18 19 20 21 22
Spark plug sockets mm:	16 18 21

Item ID: **TTESK86**



FOAM SERIES
4x4

126 Pieces 1/4" 1/2" mm

1/4" & 1/2" SOCKET SET 6 PT FOAM4X4

- Includes FRP 45 teeth quick release, flip reverse ratchets
- Includes a wide selection of 25mm screwdriver bits together with adaptors and the mini bits ratchet
- Tools are held in place using three colour pre-cut EVA foam clearly showing where each tool belongs
- Can be used as a set on it's own or as part of the TengTools "Get Organised" system
- Designed and manufactured to DIN and ISO standards

1/4" Drive	Flip reverse ratchet, Mini bits ratchet, 4" Extension bar, Universal joint, 6" Spinner handle, Coupler adaptor, 1/4"M x 1/4"Hex adaptor
1/2" Drive	Flip reverse ratchet, 17" Flex handle, 5" & 10" Extension bars, Universal joint
1/4" Drive 6 point sockets:	
Reg mm:	4 4.5 5 5.5 6 7 8 9 10
	11 12 13
Deep mm:	
	7 8 10 11 13
1/2" Drive 6 point sockets:	
Reg mm:	10 11 12 13 14 15 16 17 18
	19 20 21 24 27 30 32 34
Deep mm:	
	10 13 16 17 18 19
Spark plug sockets mm:	16 18 21
1/4" Hex bits:	3.5, 4, 4.5, 5.5 (x2), 6.5 (x2), 8 mm
	TPX10, TPX15, TPX20 (x2), TPX25 (x2), TPX27, TPX30, TPX40
	TX6, TX7, TX8, TX9, TX10, TX15, TX20 (x3), TX25 (x3), TX27, TX30 (x2), TX40
	PH1 (x4), PH2 (x7), PH3 (x2)
	PZ1 (x4), PZ2 (x7), PZ3
	2, 3, 4, 5, 6, 8 1, 2, 3 PH2G (x3)

Item ID: **TTESK126**



FOAM SERIES
4x4

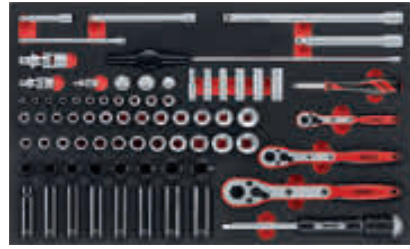

77 Pieces 1/4" 3/8" 1/2" mm

1/4", 3/8" & 1/2" SOCKET SET FOAM4X4

- Includes FRP 45 teeth quick release, flip reverse ratchets
- A selection of extension bars and adaptors to suit different applications
- Tools are held in place using three colour pre-cut EVA foam clearly showing where each tool belongs
- Can be used as a set on it's own or as part of the TengTools "Get Organised" system
- Designed and manufactured to DIN and ANSI standards

1/4" Drive	Flip reverse ratchet, 6" Spinner handle, 6" & 12" Extension bars, Universal joint, T-bar & T-bar handle adaptor
3/8" Drive	Flip reverse ratchet, 3" Wobble extension bar, 6" Extension bar, Universal joint, 3/8"F x 1/4"M adaptor, 3/8"F x 1/2"M adaptor, Rotating spinner handle
1/2" Drive	Flip reverse ratchet, 6" Wobble extension bar, 10" Extension bar, Universal joint, 1/2"F x 3/8"M adaptor
1/4" Drive 6 point sockets:	
Reg mm:	4 5 5.5 6 7 8 9 10 11 12 13
Deep mm:	6 7 8 10 12 13
3/8" Drive 6 point sockets:	
Reg mm:	8 9 10 11 12 13 14 15 16 17 18 19 22
1/2" Drive 12 point sockets:	
Reg mm:	10 11 12 13 14 15 16 17 18 19 22
1/2" Drive 6 point ANSI impact sockets:	
Reg mm:	13 15 16 17 18 19 22 24
Deep mm:	13 15 16 17 18 19 22 24

Item ID: **TTESK77**

FOAM SERIES
4x4



85 Pieces 1/4" 3/8" 1/2" mm

1/4", 3/8" & 1/2" SOCKET SET FOAM4X4

- An extensive range of short and long reach screwdriver, hex and TX bits
- Tools are held in place using three colour pre-cut EVA foam clearly showing where each tool belongs
- Designed to fit exactly in the larger TengTools tool box drawers
- Can be used as a set on it's own or as part of the TengTools "Get Organised" system
- Designed and manufactured to DIN and ISO standards

3/8" Drive	3" Extension bar
1/4" Drive bit sockets:	
mm:	4 5.5 7
PZ:	1 2 3
PH:	0 1 2 3
TX:	10 15 20 25 27 30 40
TX-E:	E4 E5 E6 E7 E8
3/8" Drive bit sockets:	
TX:	10 15 20 25 27 30 40 45 50
TPX:	10 15 20 25 27 30 40 45 50
TX-E:	E10 E12 E14 E16 E18
Hex:	3 4 5 5.5 6 7 8 10 12
1/2" Drive bit sockets:	
TX:	20 25 27 30 40 45 50 55 60
Long Hex:	5 6 7 8 10 12
Ribe:	4 5 6 8 10 11 12 13
XZN:	M5 M6 M8 M10 M12 M14 M16

Item ID: **TTESK85**



NEW



FOAM SERIES
1

16 Pieces 1/2" AF

1/2" IMPACT SOCKET SET DIN AF FOAM2

- DIN standard design for use with a retaining pin and ring.
- Chrome molybdenum for use with power tools.
- Black phosphate finish for easy identification as an impact socket.
- Ring and pin fixing hole on the female end to secure the socket.
- Retaining ring and pin included in the set.
- Tools are held in place using three colour pre-cut EVA foam clearly showing where each tool belongs
- Designed and manufactured to ASME B107.110

Retaining rings & pins: O92194, O92244, P92320, P92325 x1

1/2" Drive Impact 6 point sockets:

Reg AF:	3/8" 7/16" 1/2" 9/16" 5/8" 3/4" 13/16" 7/8" 1"
	1-1/16" 1-1/8" 1-1/4"

Item ID: **TEA9216AF**

NEW



FOAM SERIES
1

14 Pieces 1/2" AF

1/2" IMPACT SOCKET SET DEEP DIN AF FOAM2

- DIN standard design for use with a retaining pin and ring
- Chrome molybdenum for use with power tools
- Black phosphate finish for easy identification as an impact socket
- Ring and pin fixing hole on the female end to secure the socket
- Retaining ring and pin included in the set
- Tools are held in place using three colour pre-cut EVA foam clearly showing where each tool belongs
- Designed and manufactured to ASME B107.110

Retaining rings & pins: O92194, O92244, P92320, P92325 x1

1/2" Drive Impact 6 point sockets:

Deep AF:	7/16" 1/2" 9/16" 5/8" 11/16"
	3/4" 13/16" 7/8" 15/16" 1"

Item ID: **TEA9214LAF**



FOAM SERIES
2

21 Pieces 1/2" mm

1/2" IMPACT SOCKET SET ANSI FOAM2

- ANSI standard design for use with power tools with a ball bearing socket retainer
- Selection of extension bars and adaptors
- Supplied in the unique TengTools FOAM2 tray
- Tools are held in place using three colour pre-cut EVA foam clearly showing where each tool belongs

3" & 10" Extension bars, Universal joint, 3/8"F x 1/2"M & 1/2"F x 3/4"M Impact adaptors

1/2" Drive Impact 6 point sockets:

Reg mm:	13 15 16 17 18 19 22 24
Deep mm:	13 15 16 17 18 19 22 24

Item ID: **TED9121**



FOAM SERIES

4x4

73 Pieces 3/8" 1/2" mm

3/8" & 1/2" IMPACT SOCKET SET FOAM4X4

- Extension bars and adaptors included
- DIN & ANSI standard 1/2" drive sockets included
- Chrome molybdenum for use with power tools
- Designed to fit exactly in the larger TengTools tool box drawers
- Can be used as a set on it's own or as part of the TengTools "Get Organised" system
- Retaining rings and pins included

3/8" Drive	3" Extension bar, 3/8" F x 1/2" M & 3/8" F x 1/4" F Impact adaptors, Coupler adaptor for 1/4" hex bits
1/2" Drive	3", 5" & 10" Extension bars, Universal joint, 1/2" F x 3/4" M & 1/2" F x 3/8" M Impact adaptors, Coupler adaptor for 5/16" hex bits
Retaining rings & pins: O92194, O92244, P92320, P92325 x1	
3/8" Drive Impact 6 point sockets:	
Reg mm:	8 10 11 12 13 14 15 16 17
	19
Deep mm:	8 10 11 12 13 14 16 17 19
1/2" Drive Impact 6 point sockets:	
Reg mm:	8 10 11 12 13 14 15 16 17
	18 19 20 21 22 23 24 25 26
	27 28 29 30 32
Deep mm:	10 11 12 13 14 15 16 17 18
	19 21 22 24 27 28 29 30 32
	35 36

Item ID: TTEISK73



FOAM SERIES

4x4

33 Pieces 3/4" mm

3/4" IMPACT SOCKET SET DIN FOAM4X4

- Extension bars and adaptors included
- DIN standard design for use with a retaining pin and ring
- Chrome molybdenum for use with power tools
- Designed to fit exactly in the larger TengTools tool box drawers
- Can be used as a set on it's own or as part of the TengTools "Get Organised" system
- Retaining rings and pins included

7" Extension bar, Universal joint, 3/4" F x 1/2" M & 3/4" F x 1" M Impact adaptors	
Retaining rings & pins: O95036, P90435 x2	
3/4" Drive Impact 6 point sockets:	
Reg mm:	19 21 22 23 24 27 28 30 32
	33 34 36 38 41 46
Deep mm:	19 21 22 23 24 27 30 32 33
	34 36 38 41 46

Item ID: TTEISK33

TORQUE TOOLS



FOAM SERIES

1

38 Pieces 1/4"

TORQUE SCREWDRIVER SET FOAM1

- 1-5 Nm torque screwdriver with accessories
- Accurate to +/- 6% and conforms to ISO6789 for assured accuracy
- Supplied in the unique TengTools FOAM1 tray
- Tools are held in place using three colour pre-cut EVA foam clearly showing where each tool belongs

1-5Nm Torque screwdriver, 1/4" M x 1/4" Hex adaptor	
1/4" Hex bits:	3, 4.5, 5.5, 6.5 PH0, PH1, PH2, PH3 PH2G (X2)
Length 25mm	2, 3, 4, 5, 6 PZ0, PZ1, PZ2, PZ3 ROB1, 2, 3
	TX8, TX9, TX10, TX15, TX20, TX25, TX27, TX30, TX40
	TPX10, TPX15, TPX20, TPX30, TPX40

Item ID: TEASD38



FOAM SERIES

2

95 Pieces 1/4"

TORQUE SCREWDRIVER SET FOAM2

- 1-5 Nm torque screwdriver with accessories
- Accurate to +/- 6% and conforms to ISO6789 for assured accuracy
- Ratcheting bits driver set included
- Supplied in the unique TengTools FOAM2 tray
- Tools are held in place using three colour pre-cut EVA foam clearly showing where each tool belongs

1/4" Drive	1-5 Nm Torque screwdriver, Quick release chuck, Sliding T-bar, 6" Flexible extension, Ratcheting bits driver with assorted bits, 1/4" M x 1/4" hex adaptor	
1/2" Drive	1/2" M x 5/16" Hex adaptor, Reversible impact driver, 5/16" Hex bit adaptor	
5/16" Hex bits: Length 36mm	TX30, TX40, TX45, TX50, TX55 PH1, PH2, PH3, PH4	6, 8, 10, 12 4, 5, 6, 8
1/4" Hex bits: Length 25mm	3.5, 4, 4.5, 5.5 (x2), 6.5, 8 PZ1 (x3), PZ2 (x6), PZ3 PH1 (x3), PH2 (x6), PH3	1, 2, 3 2, 3, 4, 5, 6, 8 PH2G (x3)
	TX6, TX7, TX8, TX9, TX10, TX15, TX20 (x3), TX25 (x3), TX27, TX30, TX40	
	TPX10, TPX15, TPX20 (x2), TPX25 (x2), TPX27, TPX30, TPX40	

Item ID: TEDSD14



FOAM SERIES

x4

2 Pieces 3/8" 1/2"

3/8" & 1/2" TORQUE WRENCH SET FOAMX4

- Equipped with an in-built angular gauge for easier after tightening
- Click type mechanism to signal when the required torque is reached
- Additional ft/lb reference scale
- Marked to show the correct place where pressure should be applied
- Twist locking facility to ensure the set torque is maintained
- Reversible 24 teeth ratchet (DIN3122) giving 15° increments
- Designed to torque right hand (clockwise) fasteners
- Accurate to +/- 4% conforms to ISO6789 for assured accuracy
- Individually tested and certified at the time of manufacture
- Tools are held in place using three colour pre-cut EVA foam

Torque Wrenches

3/8" Drive	20-110Nm (15-81 ft/lb)
1/2" Drive	40-210Nm (30-150 ft/lb)

Item ID: **TEX1238**



FOAM SERIES

x4

2 Pieces 1/2" 3/4"

1/2" TORQUE MULTIPLIER SET FOAMX4

- Includes a 1/2" drive torque wrench giving a range of 40 to 210Nm
- The MP1400 torque multiplier can then be used to multiply the torque at a ratio of 1:3 increasing the potential torque to 630Nm
- For use with 3/4" drive sockets
- Tools are held in place using three colour pre-cut EVA foam

1/2" Drive Torque wrench (40-210Nm, 30-150 ft/lb)

1/2" F:3/4" M Torque multiplier (1 to 3 ratio) and maximum torque capacity 1,500Nm

Item ID: **TEXMP12**

SPANNERS & WRENCHES



FOAM SERIES

2

12 Pieces mm

COMBINATION SPANNER SET ANTI SLIP FOAM2

- Off set at 15° for easier use on flat surfaces
- TengTools hip grip design on the ring and open end for contact with the flat side of the fastening
- TengTools anti slip design on the open end to give a much better grip
- Tools are held in place using three colour pre-cut EVA foam

Combination Spanners:

8, 9, 10, 11, 12, 13, 14, 15, 16, 17, 18, 19 mm



Item ID: **TED8012**



FOAM SERIES

2

15 Pieces mm

COMBINATION SPANNER SET FOAM2 15 PIECES

- Off set at 15° for easier use on flat surfaces
- TengTools hip grip design for contact with the flat side of the fastening
- Tools are held in place using three colour pre-cut EVA foam
- Designed and manufactured to DIN3113A

Combination Spanners:

5.5, 6, 7, 8, 9, 10, 11, 12, 13, 14, 15, 16, 17, 18, 19 mm

Item ID: **TED6515**



FOAM SERIES

x4

7 Pieces mm

COMBINATION SPANNER SET FOAMX4 7 PIECES

- Chrome vanadium, satin finish
- Off set at 15° for easier use on flat surfaces
- TengTools hip grip design for contact with the flat side of the fastening
- Tools are held in place using three colour pre-cut EVA foam
- Designed and manufactured to DIN3113A

Combination Spanners:

20, 21, 22, 24, 27, 30, 32 mm

Item ID: **TEX2032**



FOAM SERIES

4x4

31 Pieces mm

COMBINATION SPANNER SET FOAM4X4 AF

- Off set at 15° for easier use on flat surfaces
- TengTools hip grip design for contact with the flat side of the fastening
- Chrome vanadium satin finish
- Tools are held in place using three colour pre-cut EVA foam
- Designed to fit exactly in the larger TengTools tool box drawers
- Designed and manufactured to DIN3113A

Combination Spanners:

5.5, 6, 7, 8, 9, 10, 11, 12, 13, 14, 15, 16, 17, 18, 19, 20, 21, 22, 23, 24, 25, 26, 27, 28, 29, 30, 32, 33, 34, 36, 38 mm

Item ID: **TTESP31**



FOAM SERIES

4x4

62 Pieces 1/4" 3/8" 1/2" AF

SOCKET & SPANNER SET AF FOAM4X4

- Combination spanners and a range of socketry
- Tools are held in place using three colour pre-cut EVA foam
- TengTools hip grip design for contact with the flat side of the fastening
- Chrome vanadium satin finish
- Designed to fit exactly in the larger TengTools tool box drawers
- Designed and manufactured to DIN and ISO standards

1/4" Drive 6 point sockets:

- Reg AF: 3/16" 7/32" 1/4" 9/32" 5/16" 11/32" 3/8" 7/16" 1/2"
- Deep AF: 3/16" 7/32" 1/4" 9/32" 5/16" 11/32" 3/8" 7/16" 1/2"

3/8" Drive 6 point sockets:

- Reg AF: 3/8" 7/16" 1/2" 9/16" 5/8" 11/16" 3/4"
- Deep AF: 3/8" 7/16" 1/2" 9/16" 5/8" 11/16" 3/4"

1/2" Drive 12 point sockets:

- Reg AF: 3/8" 7/16" 1/2" 9/16" 5/8" 11/16" 3/4" 13/16" 7/8" 15/16" 1" 1-1/8" 1-3/16" 1-1/4"

Combination Spanners:

5/16", 3/8", 7/16", 1/2", 9/16", 5/8", 11/16", 3/4", 13/16", 7/8", 15/16", 1", 1-1/16", 1-1/8", 1-1/4"

Item ID: **TTEAF62**



FOAM SERIES
4x4

32 Pieces mm

SPANNER & FILE SET FOAM4X4 32 PIECES

- 72 teeth ratchet spanners, turn over to change direction
- Chrome vanadium satin finish
- The five most used 10" hand files included
- Tools are held in place using three colour pre-cut EVA foam
- Designed to fit exactly in the larger TengTools tool box drawers

Combination Spanners:

8, 9, 10, 11, 12, 13, 14, 15, 16, 17, 18, 19, 20, 21, 22, 24, 27, 30, 32 mm

Ratchet Spanners:

8, 10, 11, 12, 13, 14, 17, 19 mm

10" Engineers Files:

Flat, Round, Half Round, Three Square & Hand Type Flat

Item ID: TTEX32



FOAM SERIES
2

12 Pieces mm

RATCHETING COMBI SPANNER SET R FOAM2

- 72 teeth ratchet spanners giving a 5° increment between clicks
- Reversible ratchet mechanism with hip grip & flip reverse lever
- Tools are held in place using three colour pre-cut EVA foam
- Designed and manufactured to DIN ISO 1711-1 and DIN 3113A

Ratchet Spanners with flip reverse switch:

8, 9, 10, 11, 12, 13, 14, 15, 16, 17, 18, 19 mm

Item ID: TED6512R



FOAM SERIES
2

12 Pieces mm

RATCHETING COMBI SPANNER SET RS FOAM2

- 72 teeth ratchet spanners giving a 5° increment between clicks
- Hip grip on the ring end, turn spanner over to change direction
- Tools are held in place using three colour pre-cut EVA foam
- Designed and manufactured to DIN ISO 1711-1 and DIN 3113A

Ratchet Spanners:

8, 9, 10, 11, 12, 13, 14, 15, 16, 17, 18, 19 mm

Item ID: TED6512RS

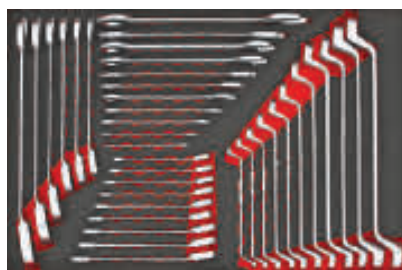

FOAM SERIES
4x4

37 Pieces mm

SPANNER SET FOAM4X4 37 PIECES

- 72 teeth ratcheting combination spanners with flip reverse lever
- Double open ended and double ring spanners
- Chrome vanadium satin finish
- Tools are held in place using three colour pre-cut EVA foam
- Designed to fit exactly in the larger TengTools tool box drawers
- Designed and manufactured to DIN and ISO standards

Ratchet Spanners:

8, 9, 10, 11, 12, 13, 14, 15, 16, 17, 18, 19, 22, 24, 27 mm

Double Open Ended Spanners:

6x7, 8x9, 10x11, 12x13, 14x15, 16x17, 18x19, 20x22, 21x23, 24x27, 30x32 mm

Double Ring Spanners:

6x7, 8x9, 10x11, 12x13, 14x15, 16x17, 18x19, 20x22, 21x23, 24x27, 30x32 mm

Item ID: TTESP37



FOAM SERIES
x4

8 Pieces mm

DOUBLE RING SPANNER SET FOAMX4 8 PIECES

- Different size at each end to give 16 sizes in total
- Double curved heads offset at 75° for easier use on flat surfaces
- Chrome vanadium satin finish
- TengTools hip grip design for contact with the flat side of the fastening
- Tools are held in place using three colour pre-cut EVA foam
- Designed and manufactured to DIN838

Double Ring Spanners:

6x7, 8x9, 10x11, 12x13, 14x15, 16x17, 18x19, 20x22 mm

Item ID: TEX6308



FOAM SERIES
x4

6 Pieces mm

LONG DOUBLE RING SPANNER SET FOAMX4

- Different size at each end to give 12 sizes in total
- Extra long, flat design for extra torque
- Chrome vanadium satin finish
- TengTools hip grip design for contact with the flat side of the fastening
- Tools are held in place using three colour pre-cut EVA foam
- Designed and manufactured to DIN837

Extra long Double Ring Spanners:

8x10, 11x13, 12x14, 16x18, 17x19, 22x24 mm

Item ID: TEXFLS06



FOAM SERIES
2

7 Pieces mm

DOUBLE FLEX WRENCH SET FOAM2 7 PIECES

- Swivel end wrenches for fast pre-tightening and loosening
- Angle at 90° for added torque when applying the final tightening
- Extra torque for loosening stubborn fastenings
- Tools are held in place using three colour pre-cut EVA foam
- Designed and manufactured to DIN standard

Double Flex Wrenches

8x9, 10x11, 12x13, 14x15, 16x17, 18x19 mm

B-flex Wrench:

1/4" Male x 1/4" Hex Female

Item ID: TEDDF7



FOAM SERIES
2

4 Pieces TPR GRIP

ADJUSTABLE WRENCH SET FOAM2 4 PIECES

- Includes regular style 6, 8 and 10" adjustable wrenches
- Also includes an 8" wide jaw adjustable wrench for added versatility
- Tools are held in place using three colour pre-cut EVA foam
- Designed and manufactured to DIN3117 and ISO6787

Adjustable Wrenches

6" (150 mm) Capacity: 24 mm

8" (200 mm) Capacity: 28 mm

10" (250 mm) Capacity: 33 mm

8" (200 mm) Wide Jaw Capacity: 38 mm

Item ID: TEDADJ4

SCREWDRIVERS

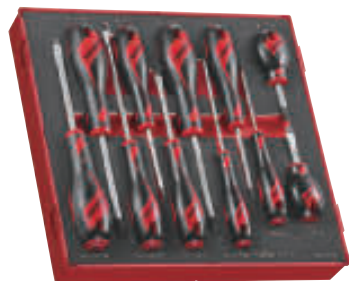

FOAM SERIES



SCREWDRIVER SET MIXED FOAM2 11 PIECES

- TT-MV PLUS steel alloy for greater strength and material flexibility
- Ergonomically designed bi-material handle for easy use with higher torque
- Hanging hole in the handle for use as a T handle or with a fall protection wire
- The handle is moulded around the blade to give a higher torque capacity
- Tools are held in place using three colour pre-cut EVA foam

Screwdrivers:					
-	mm:	3.5 x 100	5.5 x 75	6.5 x 38	5.5 x 125
		6.5 x 100			
+	mm:	PH0 x 75	PH1 x 75	PH2 x 38	PH2 x 100
+	mm:	PZ1 x 75	PZ2 x 100		

Item ID: TED911N



FOAM SERIES



SCREWDRIVER SET FLAT & PH FOAMX4 5 PIECES

- TT-MV PLUS steel alloy for greater strength and material flexibility
- Ergonomically designed bi-material handle for easy use with higher torque
- Hanging hole in the handle for use as a T handle or with a fall protection wire
- The handle is moulded around the blade to give a higher torque capacity
- Tools are held in place using three colour pre-cut EVA foam

Screwdrivers:					
-	mm:	5.5 x 150	6.5 x 150	8 x 150	10 x 200
+	mm:	PH3 x 150			

Item ID: TEX915N



FOAM SERIES



SCREWDRIVER SET TX FOAM2 9 PIECES

- TT-MV PLUS steel alloy for greater strength and material flexibility
- Ergonomically designed bi-material handle for easy use with higher torque
- Hanging hole in the handle for use as a T handle or with a fall protection wire
- The handle is moulded around the blade to give a higher torque capacity
- Tools are held in place using three colour pre-cut EVA foam

Screwdrivers:				
*	mm:	TX6 x 75	TX8 x 75	TX9 x 75
		TX10 x 100	TX15 x 100	TX20 x 100
		TX25 x 100	TX27 x 100	TX30 x 100

Item ID: TED909TXN



FOAM SERIES



SCREWDRIVER SET MIXED FOAM4X4 122 PIECES

- TT-MV PLUS steel alloy for greater strength and material flexibility
- Ergonomically designed bi-material handle for easy use with higher torque
- Hanging hole in the handle for use as a T handle or with a fall protection wire
- The handle is moulded around the blade to give a higher torque capacity
- Tools are held in place using three colour pre-cut EVA foam
- Designed to fit exactly in the larger TengTools tool box drawers
- Can be used as a set on it's own or as part of the TengTools "Get Organised" system

Screwdrivers:					
-	mm:	2.5 x 75	3.5 x 75	3 x 100	4 x 100
		5.5 x 75	5.5 x 150	6.5 x 38	6.5 x 100
+	mm:	PH0 x 75	PH1 x 38	PH1 x 75	PH2 x 38
		PH2 x 100	PH3 x 150	PH4 x 200	
+	mm:	PZ0 x 75	PZ1 x 38	PZ1 x 100	PZ2 x 38
		PZ2 x 100	PZ2 x 150	PZ3 x 150	
1/4" Hex bits: Length 25mm	-	0.6x3.5, 0.6x4.5, 0.8x4(x2), 0.8x5.5, 1.0x5.5(x2), 1.2x6.5, 1.6x8			
	*	TPX10, TPX15, TPX20 (x2), TPX25 (x2), TPX27, TPX30, TPX40			
*		TX6, TX7, TX8, TX9, TX10, TX15, TX20 (x3), TX25 (x3), TX27, TX30, TX40			
	+	PH1 (x3), PH2 (x3), PH3 (x3)			
*		PZ1 (x3), PZ2 (x3), PZ3 (x3)			
		2, 3, 4, 5, 6, 8	1, 2, 3	PH2G (x3)	
1/4" Hex bits: Length 50mm	-	0.6x3.5, 0.8x4, 0.8x5.5, 1x5.5, 1.2x6.5			
	*	TX8, TX10 (x2), TX15, TX20 (x2), TX25 (x2), TX27, TX30			
+		PH1, PH2 (x2), PH3			
	*	PZ1, PZ2 (x2), PZ3			
6 in 1 Ratchetting Bits Driver Set					
Bit Holder For 25 mm Bits					

Item ID: TTEMD122N



FOAM SERIES



SCREWDRIVER SET MIXED FOAM4X4 98 PIECES

- TT-MV PLUS steel alloy for greater strength and material flexibility
- Ergonomically designed bi-material handle for easy use with higher torque
- Hanging hole in the handle for use as a T handle or with a fall protection wire
- The handle is moulded around the blade to give a higher torque capacity
- Mini screwdrivers feature a rotating end piece for easier use

Screwdrivers:				
-	mm:	2.5 x 75	4 x 100	5.5 x 125
	+	mm:	PH0 x 60	PH1 x 80
+			PZ2 x 100	
	*	mm:	TX8 x 75	TX9 x 75
*		mm:	TPX10 x 100	TPX15 x 100
			TPX25 x 100	TPX30 x 100
Mini Screwdrivers:				
-	mm:	2 x 40	2.5 x 40	3 x 40
	+	mm:	PH00 x 40	PH0 x 40
*		mm:	TX6 x 40	TX7 x 40
		TX9 x 40	TX10 x 40	TX15 x 40
Power Through Screwdrivers:				
-	mm:	6.5 x 100	8 x 150	10 x 200
	+	mm:	PH2 x 100	
		PH3 x 150		
1/4" Hex bits: Length 25mm	-	0.6x3.5, 0.6x4.5, 0.8x4(x2), 0.8x5.5, 1x5.5(x2), 1.2x6.5, 1.6x8		
	*	TPX10, TPX15, TPX20 (x2), TPX25 (x2), TPX27, TPX30, TPX40		
*		TX6, TX7, TX8, TX10, TX15, TX20 (x3), TX25 (x3), TX27, TX30, TX40		
	+	PH1 (x3), PH2 (x3), PH3 (x3)		
+		PZ1 (x3), PZ2 (x3), PZ3 (x4)		
		2, 3, 4, 5, 6, 8	1, 2, 3	PH2G (x3)
6 in 1 Ratchetting Bits Driver Set, Magnetic Charger For Magnetising / Demagnetising Screwdriver Tips, 1/4" M: 1/4" Hex Adaptor, Coupler Adaptor				

Item ID: TTEMD98N

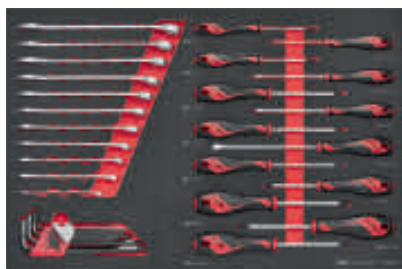

FOAM SERIES
4x4

33 Pieces

SCREWDRIVER & SPANNER SET FOAM4X4

- Selection of screwdrivers with ergonomically designed handles
- Chrome vanadium combination spanners
- Hex key set also included
- Tools are held in place using three colour pre-cut EVA foam

Combination Spanners:

8, 10, 11, 12, 13, 14, 15, 16, 17, 18, 19 mm

Hex Key Set:

1.5, 2.0, 2.5, 3.0, 4.0, 5.0, 6.0, 8.0, 10.0 mm

Screwdrivers:

mm: 2.5 x 75 3.5 x 100 4.0 x 100 5.5 x 150

mm: PH1 x 75 PH2 x 100

mm: TX8 x 75 TX9 x 75

mm: TPX10 x 100 TPX15 x 100 TPX20 x 100 TPX25 x 100 TPX30 x 100

Item ID: TTEMD33



FOAM SERIES

3

54 Pieces

SCREWDRIVER & HEX/TX KEY SET 1 FOAM3

- Selection of screwdrivers with other general tools
- Metric measuring tape
- Tools are held in place using three colour pre-cut EVA foam
- Designed to fit exactly in the TengTools service cases

Ball Point Hex Keys:

mm: 1.5, 2.0, 2.5, 3.0, 4.0, 5.0, 6.0, 7.0, 10.0

TX Keys:

TX: 8, 9, 10, 15, 20, 25, 27, 30, 40

25 mm Bits:

mm 3.5, 5.5, 8.0

PH1, PH2, PH3

PZ1, PZ2, PZ3

10, 15, 20, 25, 30, 40

20, 25, 30

mm 2, 3, 4, 5, 6, 8

1, 2, 3

7 mm Hose Clip Drivers

100 mm Quick Chuck Bits Driver

5 m Measuring Tape - Metric Only

Item ID: TEFMD54



FOAM SERIES

3

54 Pieces

SCREWDRIVER & HEX/TX KEY SET 2 FOAM3

- Selection of screwdrivers with other general tools
- Metric/inch measuring tape
- Tools are held in place using three colour pre-cut EVA foam
- Designed to fit exactly in the TengTools service cases

Ball Point Hex Keys:

mm: 1.5, 2.0, 2.5, 3.0, 4.0, 5.0, 6.0, 7.0, 10.0

TX Keys:

TX: 8, 9, 10, 15, 20, 25, 27, 30, 40

25 mm Bits:

mm 3.5, 5.5, 8.0

PH1, PH2, PH3

PZ1, PZ2, PZ3

10, 15, 20, 25, 30, 40

20, 25, 30

mm 2, 3, 4, 5, 6, 8

1, 2, 3

7 mm Hose Clip Drivers

100 mm Quick Chuck Bits Driver

5 m Measuring Tape - Metric & AF

Item ID: TEFMDI54



FOAM SERIES

X4

5 Pieces

POWER THROUGH SCREWDRIVER SET FOAMX4

- Chrome vanadium blades for greater strength and material flexibility
- Percussion cap and full length integral blade for use with a hammer to release stubborn screws
- Ergonomically designed bi-material handle for easy use with higher torque
- The handle is moulded around the blade to give a higher torque capacity
- Tools are held in place using three colour pre-cut EVA foam

Screwdrivers:		
mm: 6.5 x 100	8 x 150	10 x 200
mm: PH2 x 100	PH3 x 150	

Item ID: TEXMDTN

BITS & DRIVER SETS



FOAM SERIES
1

78 Pieces 1/4"

BITS DRIVER SET FOAM1 78 PIECES

- Various drivers and accessories for use with bits and/or sockets
- Includes the TengTools mini bits ratchet adaptor for use with the quick chuck bits driver to create a reversible 1/4" drive ratchet
- Tools are held in place using three colour pre-cut EVA foam

147mm Quick chuck driver, 1/4" drive ratchet head adaptor, 1/4" M x 1/4" Hex adaptor, 50mm Bit holder

1/4" Drive Regular 6 point sockets:

mm: 4, 5, 5.5, 6, 7, 8, 9, 10, 11, 12, 13 mm

1/4" Hex bits:

Length 25mm:	3.5, 4.0, 4.5, 5.5 (x2), 6.5, 8.0 mm	PH2G (x3)
	PH1 (x3), PH2 (x6), PH3	ROB1, 2, 3
	TX6, TX7, TX8, TX9, TX10, TX15, TX20 (x3), TX25 (x3), TX27, TX30, TX40	
	TPX10, TPX15, TPX20 (x2), TPX25 (x2), TPX27, TPX30, TPX40	
	PZ1 (x3), PZ2 (x6), PZ3	2, 3, 4, 5, 6, 8

Item ID: **TEAMDQ78**

FOAM SERIES
1



50 Pieces

IMPACT BIT SET FOAM1 50 PIECES

- Magnetic and quick chuck bit holders included for fast changing
- Designed for higher torsion
- Tools are held in place using three colour pre-cut EVA foam

60mm Impact magnetic bit holder, 60mm Impact quick chuck bit holder

1/4" Hex Impact Bits: Length 30mm	PH1, PH2 (x2), PH3	PH2G (x2)
	PZ1, PZ2 (x2), PZ3	3, 4 (x2), 5, 6
	TX10, TX15, TX20 (x2), TX25 (x2), TX27, TX30 (x2), TX40	1, 2
1/4" Hex Impact Bits: Length 50mm	PH1, PH2, PH3	3, 4, 5, 6
	PZ1, PZ2, PZ3	1, 2, 3
	PH2G	
	TX10, TX15, TX20, TX25, TX27, TX30, TX40	

Item ID: **TEABS50**

HEX & TX KEYS



FOAM SERIES
2

7 Pieces mm

T-HANDLE BALL POINT HEX KEY SET FOAM2

- Ball point end on the long key end giving access at angles of up to 25°
- Regular hex end on the short arm giving the ability to apply higher torque
- Tools are held in place using three colour pre-cut EVA foam

Ball Point T-Handle Hex Drivers:

100 mm long:	2.5, 3, 4 mm
150 mm long:	5, 6, 7 mm
190 mm long:	8 mm

Item ID: **TEDHEX7**



FOAM SERIES
2

7 Pieces

T-HANDLE BALL POINT TX KEY SET FOAM2

- TPX end on the long key end for use with tamper proof TPX fastenings
- Regular TX end on the short arm giving the ability to apply higher torque
- Tools are held in place using three colour pre-cut EVA foam

T-Handle TX Drivers:

100 mm long:	TX/TPX10, TX/TPX15, TX/TPX20
150 mm long:	TX/TPX25, TX/TPX27, TX/TPX30
190 mm long:	TX/TPX40

Item ID: **TEDTX7**



FOAM SERIES
2

42 Pieces mm AF

BALL POINT HEX & TX KEY SET FOAM2

- Includes metric and inch hex keys
- TX keys and mini TX keys
- Also includes a handy fold up key set including hex, TX and screwdriver blades
- Tools are held in place using three colour pre-cut EVA foam

Ball Point Hex & TX Keys:

1.5, 2, 2.5, 3, 4, 5, 6, 7, 8, 10 mm
5/64", 3/32", 1/8", 5/32", 3/16", 7/32", 1/4", 5/16", 3/8"
TX8, TX9, TX10, TX15, TX20, TX25, TX27, TX30, TX40

Mini TX Keys:

TX6, TX7, TX8, TX9, TX10, TX15

Fold Up Key Set:

4, 5, 6mm Hex, TX25, TX30, 5.5mm Flat, PH2, PZ2

Item ID: **TEDHT42**

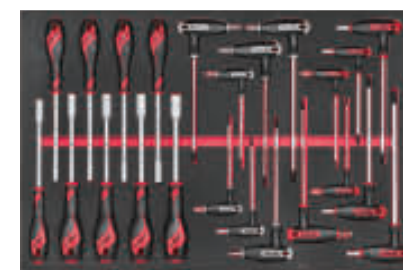

FOAM SERIES
2

23 Pieces mm

NUT DRIVER & HEX/TX T-HANDLE SET FOAM4X4

- Includes metric nut drivers and T handle hex and TX/TPX drivers
- Ergonomically designed bi-material handles for higher torque
- Hanging hole in the handle for use as a T handle for extra torque or with a fall protection wire
- The handle is moulded around the blade which gives a higher torque capacity
- Tools are held in place using three colour pre-cut EVA foam
- Designed to fit exactly in the larger TengTools tool box drawers

Nut Drivers:

5, 5.5, 6, 7, 8, 10, 11, 12, 13 mm

T Handle Hex & TX Keys:

2.5, 3, 4, 5, 6, 7, 8 mm

TX/TPX10, TX/TPX15, TX/TPX20, TX/TPX25, TX/TPX27, TX/TPX30, TX/TPX40

Item ID: **TTEX23N**

PLIERS



FOAM SERIES
2

5 Pieces
TPR GRIP

PLIER SET TPR GRIP FOAM2 5 PIECES

- TPR grip for a more secure and comfortable grip
- All the most commonly used pliers in one set
- Supplied in the unique TengTools double width TC tray
- Tools are held in place using three colour pre-cut EVA foam clearly showing where each tool belongs

Pliers:	
SIDE CUTTER	5" / 135 mm
HEAVY DUTY SIDE CUTTERS	8" / 200 mm
HIGH LEVERAGE COMBINATION	8" / 200 mm
LONG NOSE	8" / 200 mm
WATER PUMP	10" / 250 mm

Item ID: **TED441-T**



FOAM SERIES
2

11 Pieces
TPR GRIP

PLIER SET FOAM4X4 11 PIECES

- Includes all the most commonly used pliers, circlip pliers and power grip pliers in one set
- Tools are held in place using three colour pre-cut EVA foam clearly showing where each tool belongs
- Designed to fit exactly in the larger TengTools tool box drawers
- Can be used as a set on it's own or as part of the TengTools "Get Organised" system

Pliers:	
HEAVY DUTY SIDE CUTTERS	8" / 200 mm
HIGH LEVERAGE COMBINATION	7" / 180 mm
LONG NOSE	8" / 200 mm
WATER PUMP	10" / 250 mm
Circlip Pliers:	
STRAIGHT INNER	7" / 175 mm
BENT INNER	7" / 175 mm
STRAIGHT OUTER	7" / 175 mm
BENT OUTER	7" / 175 mm
POWER GRIP Pliers:	
LONG NOSE STRAIGHT JAW	6" / 155 mm
REGULAR CURVED JAW	4" / 100 mm 10" / 250 mm

Item ID: **TTEMB11**



FOAM SERIES
4x4

17 Pieces
TPR GRIP

PLIER SET FOAM4X4 17 PIECES

- Includes all the most commonly used pliers in one set
- TPR grip for a more secure and comfortable grip
- Circlip Pliers with vinyl grip
- Tools are held in place using three colour pre-cut EVA foam clearly showing where each tool belongs
- Designed to fit exactly in the larger TengTools tool box drawers
- Can be used as a set on it's own or as part of the TengTools "Get Organised" system

Pliers:	
SIDE CUTTERS	5" / 135 mm 6" / 155 mm
HEAVY DUTY SIDE CUTTERS	6" / 160 mm 8" / 200 mm
OFFSET HEAVY DUTY SIDE CUTTERS	8" / 200 mm
CABLE CUTTERS	8" / 208 mm
HIGH LEVERAGE COMBINATION	7" / 180 mm 8" / 200 mm
LONG NOSE	8" / 200 mm
FLAT LONG NOSE	6" / 165 mm
WIRE STRIPPERS	6" / 155 mm
WATER PUMP	7" / 180 mm 10" / 250 mm
Circlip Pliers:	
STRAIGHT INNER	7" / 175 mm
BENT INNER	7" / 175 mm
STRAIGHT OUTER	7" / 175 mm
BENT OUTER	7" / 175 mm

Item ID: **TTEMB17**

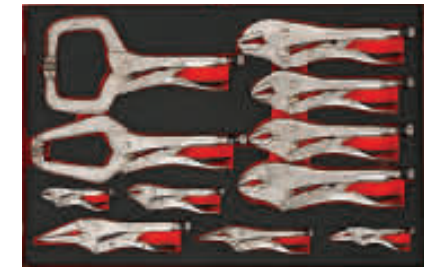

FOAM SERIES
4x4

11 Pieces

POWER GRIP PLIER SET FOAM4X4 11 PIECES

- Includes all the most commonly used power grip pliers and welding pliers in one set
- Tools are held in place using three colour pre-cut EVA foam clearly showing where each tool belongs
- Designed to fit exactly in the larger TengTools tool box drawers
- Can be used as a set on it's own or as part of the TengTools "Get Organised" system

Power Grip Pliers:	
STANDARD ROUND JAW	4" / 100 mm 7" / 180 mm 10" / 250 mm 12" / 300 mm
STANDARD FLAT JAW	10" / 250 mm 12" / 300 mm
LONG NOSE	4" / 100 mm 6" / 155 mm 9" / 230 mm
C CLAMP PLIER	11" / 285 mm
SELF LEVELLING LOCKING PLIER	12" / 300 mm

Item ID: **TTEVG11**

INSULATED TOOLS



FOAM SERIES
2



INSULATED SCREWDRIVER SET MIXED FOAM2

- Approved for live working up to 1,000 volts
- Integrated protective insulation with two colours to clearly indicate if there is any damage
- A 100-250 volt tester is also included for checking circuits
- Tools are held in place using three colour pre-cut EVA foam
- Designed and manufactured to DIN ISO 8764-1, DIN ISO 2380 and IEC 60900

100-250V Voltage Tester				
1000V Insulated Screwdrivers:				
⊖	mm: 2.5 x 75	3 x 100	4 x 100	5.5 x 125
⊕	mm: PH0 x 60	PH1 x 80	PH2 x 100	
⊕	mm: PZ2 x 100			

Item ID: **TEDV909N**

NEW



TT SERIES
1



TORQUE SCREWDRIVER BLADE SET FOAM1

- Slim blades with reduced blade diameter for easier access to recessed screws and spring elements
- Approved for live working up to 1,000 volts
- Tools are held in place using three colour pre-cut EVA foam
- Designed and manufactured to IEC60900

Torque Screwdriver 1/4 in 1-5Nm 1000V			
1000V Insulated Screwdriver blades:			
⊖	Reg mm:	3 x 70	
⊖	Slim mm:	4 x 100	5.5 x 80 6.5 x 100
⊕	Slim mm:	PH1 x 80	PH2 x 100
⊕	Slim mm:	PZ1 x 80	PZ2 x 100

Item ID: **TEAVSD09**



FOAM SERIES
2



INSULATED PLIER SET FOAM2 4 PIECES

- Approved for live working up to 1,000 volts
- TPR grip for a more secure and comfortable grip
- Tools are held in place using three colour pre-cut EVA foam
- Designed and manufactured to DIN5745, DIN5746, DIN5749 and IEC 60900

1000V Insulated Pliers:	
SIDE CUTTER	6" / 150 mm
LONG NOSE PLIERS	8" / 200 mm
COMBINATION PLIERS	8" / 200 mm
WIRE STRIPPING PLIERS	6" / 155 mm

Item ID: **TEDV440**

NEW



TT SERIES
2

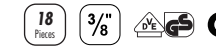

INSULATED SOCKET SET 3/8" DRIVE 18 PIECES

- Approved for live working up to 1,000 volts
- 6 point single hexagon socket for a better grip
- Integrated protective insulation with two colours to clearly indicate if there is any damage to the insulation
- Tools are held in place using three colour pre-cut EVA foam clearly showing where each tools belongs
- Designed and manufactured to DIN, ISO and IEC 60900 standards

3/8" Drive Insulated Ratchet									
3" and 6" Insulated Extension bars									
Regular 6 point Insulated sockets:									
⊖	mm:	6	7	8	9	10	11	12	13
		14	15	16	17	18	19	20	

Item ID: **TEDV3818**

MEASURING TOOLS



FOAM SERIES
2



MEASURING TOOL SET FOAM2 3 PIECES

- Ideal for machinists and technicians
- Includes a digital 4 function caliper, micrometer and a dial indicator complete with a magnetic stand
- Tools are held in place using three colour pre-cut EVA foam

Measuring Tools:	
Digital Caliper	150mm / 6"
Micrometer	0-25mm
Dial Indicator with Stand	0-10mm measuring range
Magnetic Stand with Central Locking	

Item ID: **TEDIMM**

AUTO TOOLS



FOAM SERIES
x4



3/8" T BAR SPARK PLUG SOCKET SET FOAMX4

- Extra long swivelling magnetic spark plug sockets for use in hard to reach places
- T bar with the TengTools T-HD handle for more comfortable use

2 Piece T-bar handle	
3/8" Drive extra long swivelling spark plug sockets:	
⊖	mm: 14 16 21

Item ID: **TEXTB05**



FOAM SERIES
x4

5 Pieces 1/2" mm

WHEEL TOOL SET FOAMX4 5 PIECES

- 17" 1/2" drive flex handle for shifting stubborn wheel nuts
- A short extension bar for reaching into recessed wheel rims
- Long reach sockets with protective nylon sleeves to avoid damage to wheels
- Tools are held in place using three colour pre-cut EVA foam

1/2" Drive Accessories:

17" Flex Handle, 5" Extension bar

Impact Wheel Nut Sockets:

17, 19, 21mm

Item ID: **TEXW05**

SERVICE TOOLS



FOAM SERIES
2

14 Pieces

PUNCH & CHISEL SET FOAM2 14 PIECES

- Flat cold chisel made from chrome molybdenum
- Pin punches made from chrome molybdenum
- Automatic centre punch with spring loaded stroke for marking points quickly
- Tools are held in place using three colour pre-cut EVA foam

Punches:

Centre	Length: 150 mm	4, 5, 8 mm, Automatic centre punch
Parallel	Length: 150 mm	3, 4, 5, 6, 7, 8 mm

Flat cold chisels:

150 mm	Width: 19 mm
200 mm	Width: 25 mm
240 mm	Width: 26 mm
250 mm	Width: 25 mm

Item ID: **TEDPC14**



FOAM SERIES
x4

4 Pieces

PRY BAR SET ROLL/HEEL FOAMX4 4 PIECES

- Includes 3 roll/heel bars and a 20" tyre lever
- Tools are held in place using three colour pre-cut EVA foam

Roll heel bars:

12", 16", 20"

Tyre Lever:

20"

Item ID: **TEXPB4**



FOAM SERIES
1

81 Pieces

RIVET GUN SET FOAM1 81 PIECES

- Aluminium alloy and forged steel construction
- Light weight design for more comfortable use
- PVC grip for added comfort
- Suitable for use with 2.4, 3.2, 4.0 and 4.8mm rivets
- Selection of rivets included
- Tools are held in place using three colour pre-cut EVA foam

Hand rivetter:

4 nozzles to suit aluminium/steel blind rivets (2.4, 3.2, 4.0, 4.8 mm)

Aluminium rivets:

2.4mm (3/32") x 20 black
3.2mm (1/8") x 20 black
4.0mm (5/32") x 20 black
4.8mm (3/16") x 20 black

Accessories:

Nozzle wrench

Item ID: **TEAHR81**

WALL RACKS

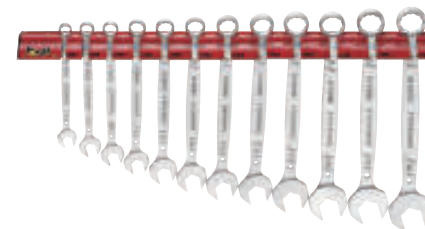

12 Pieces mm

COMBINATION SPANNER ANTI SLIP WALL RACK

- Off set at 15° for easier use on flat surfaces
- TengTools hip grip design on the ring and open end for contact with the flat side of the fastening
- TengTools anti slip design on the open end to give a much better grip
- Supplied with a wall rack for fixing to the wall or a workbench

Anti Slip Combination Spanners:

8, 9, 10, 11, 12, 13, 14, 15, 16, 17, 18, 19 mm



Item ID: **WR8012**



12 Pieces mm

COMBINATION SPANNER 8-19 MM WALL RACK

- Off set at 15° for easier use on flat surfaces
- TengTools hip grip design for contact with the flat side of the fastening
- Chrome vanadium satin finish
- Supplied with a wall rack for fixing to the wall or a workbench
- Designed and manufactured to DIN3113A

Combination Spanners:

8, 9, 10, 11, 12, 13, 14, 15, 16, 17, 18, 19 mm

Item ID: **WRSP12**



12 Pieces mm

LONG COMBINATION SPANNER WALL RACK

- Extra long for increased torque
- Off set at 15° for easier use on flat surfaces
- TengTools hip grip design for contact with the flat side of the fastening
- Supplied with a wall rack for fixing to the wall or a workbench
- Designed and manufactured to DIN3113A

Long Combination Spanners:

8, 9, 10, 11, 12, 13, 14, 15, 16, 17, 18, 19 mm

Item ID: **WRSP12LMP**



12 Pieces mm

RATCHETING COMBI SPANNER RS WALL RACK

- 72 teeth ratchet spanners giving a 5° increment between clicks
- Simply turn over to reverse the direction of use when ratcheting
- Chrome vanadium satin finish
- Supplied with a wall rack for fixing to the wall or a workbench
- Designed and manufactured to DIN ISO 1711-1 and DIN 3113A

Ratchet Spanners:

8, 9, 10, 11, 12, 13, 14, 15, 16, 17, 18, 19 mm

Item ID: **WRSP12RS**



5 Pieces mm

LONG DOUBLE RING SPANNER WALL RACK

- Different size at each end to give 10 sizes in total
- Extra long, flat design for extra torque and easier access
- Chrome vanadium satin finish
- TengTools hip grip design for contact with the flat side of the fastening
- Supplied with a wall rack for fixing to the wall or a workbench

Extra long Double Ring Spanners:

8x10, 11x13, 12x14, 17x19, 22x24 mm

Item ID: **WRFLS05**



6 Pieces mm

DOUBLE FLEX WRENCH SET WALL RACK

- Swivel end wrenches for fast pre-tightening and loosening
- Angle at 90° for added torque when applying the final tightening
- Extra torque for loosening stubborn fastenings
- Chrome vanadium satin finish
- Supplied with a wall rack for fixing to the wall or a workbench

Double Flex Wrenches

8x9, 10x11, 12x13, 14x15, 16x17, 18x19 mm

Item ID: **WRDF06**

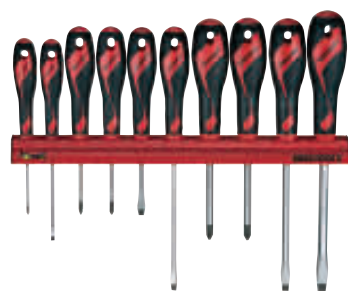

10 Pieces

SCREWDRIVER SET WALL RACK 10 PIECES

- TT-MV PLUS steel alloy for greater strength and material flexibility
- Ergonomically designed bi-material handle for easy use with higher torque
- The handle is moulded around the blade to ensure straightness
- Supplied with a wall rack for fixing to the wall or a workbench

Screwdrivers:

-	mm:	3 x 100	5.5 x 75	5.5 x 150
		6.5 x 150	8 x 150	
+	mm:	PH0 x 75	PH1 x 75	PH2 x 100
+	mm:	PZ1 x 75	PZ2 x 100	

Item ID: **WRMD10N**

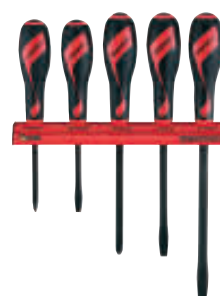

5 Pieces

POWER THROUGH SCREWDRIVER WALL RACK

- Chrome vanadium blades for greater strength
- Percussion cap and full length integral blade for use with a hammer
- Ergonomically designed bi-material handle for easy use with higher torque
- The handle is moulded around the blade to ensure straightness
- Supplied with a wall rack for fixing to the wall or a workbench

Power Through Screwdrivers:

-	mm:	6.5 x 100	8 x 150	10 x 200
+	mm:	PH2 x 100	PH3 x 150	

Item ID: **WRMDT05N**



7 Pieces mm

T-HANDLE BALL POINT HEX KEY WALL RACK

- Ball point end on the long key end giving access at angles of up to 25°
- Regular hex end on the short arm to apply higher torque to stubborn fastenings
- Supplied with a wall rack for fixing to the wall or a workbench

Ball Point T-Handle Hex Drivers:

●	100 mm long:	2.5, 3, 4 mm
●	150 mm long:	5, 6, 7 mm
●	190 mm long:	8 mm

Item ID: **WRHEX07**



7 Pieces AF

T-HANDLE BALL POINT HEX KEY AF WALL RACK

- Ball point end on the long key end giving access at angles of up to 25°
- Regular hex end on the short arm to apply higher torque to stubborn fastenings
- Supplied with a wall rack for fixing to the wall or a workbench
- Template and fixings included

Ball Point T-Handle Hex Drivers:

●	100 mm long:	3/32", 1/8", 5/32"
●	150 mm long:	3/16", 7/32", 1/4"
●	190 mm long:	5/16"

Item ID: **WRHEX07AF**



7 Pieces

T-HANDLE TX/TPX KEY WALL RACK

- TPX type on the long key end for tamper proof TX fastenings
- Regular TX end on the short arm to apply higher torque to stubborn fastenings
- Supplied with a wall rack for fixing to the wall or a workbench

T-Handle TX Drivers:

●	100 mm long:	TX/TPX10, TX/TPX15, TX/TPX20
●	150 mm long:	TX/TPX25, TX/TPX27, TX/TPX30
●	190 mm long:	TX/TPX40

Item ID: **WRTX07**



4 Pieces TPR GRIP

PLIER SET WALL RACK 4 PIECES

- TPR grip for a more secure and comfortable grip
- All the most commonly used pliers in one set
- Supplied with a wall rack for fixing to the wall or a workbench

Pliers:	
SIDE CUTTER	6" / 155 mm
HIGH LEVERAGE COMBINATION PLIERS	7" / 180 mm
LONG NOSE PLIERS	8" / 200 mm
WATER PUMP PLIERS	10" / 250 mm

Item ID: **WRMB04**

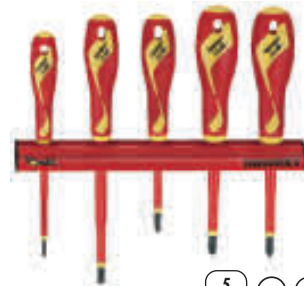

5 Pieces

INSULATED SCREWDRIVER MIXED WALL RACK

- Approved for live working up to 1,000 volts
- Protective insulation with two colours to clearly indicate if there is any damage to the insulation
- Supplied with a wall rack for fixing to the wall or a workbench
- Designed and manufactured to DIN ISO 2380, DIN ISO 8764-1 and IEC60900

1000V Insulated Screwdrivers:		
mm:	3 x 100	5.5 x 125
mm:	PH1 x 80	PH2 x 100
mm:	PZ2 x 100	

Item ID: **WRMDV05N**

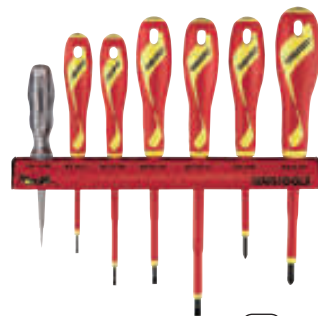

7 Pieces

INSULATED SCREWDRIVER FLAT & PH WALL RACK

- Approved for live working up to 1,000 volts
- Protective insulation with two colours to clearly indicate if there is any damage to the insulation
- Supplied with a wall rack for fixing to the wall or a workbench
- Designed and manufactured to DIN ISO 2380, DIN ISO 8764-1 and IEC60900

105 - 250V Voltage Tester				
1000V Insulated Screwdrivers:				
mm:	2.5 x 75	3 x 100	4 x 100	5.5 x 125
mm:	PH1 x 80	PH2 x 100		

Item ID: **WRMDV07N**

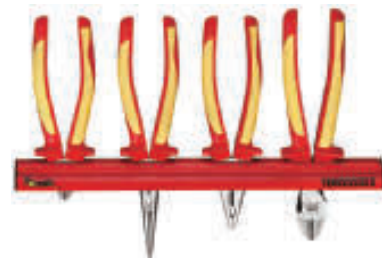

4 Pieces TPR GRIP

INSULATED PLIER SET WALL RACK 4 PIECES

- Approved for live working up to 1,000 volts
- TPR grip for a more secure and comfortable grip
- Supplied with a wall rack for fixing to the wall or a workbench
- Designed and manufactured to DIN5745, DIN5746, DIN5749 and IEC60900

1000V Insulated Pliers:	
SIDE CUTTER	6" / 150 mm
HEAVY DUTY SIDE CUTTER	8" / 200 mm
LONG NOSE PLIERS	8" / 200 mm
COMBINATION PLIERS	7" / 175 mm

Item ID: **WRMBV04**



5 Pieces

HAND FILE SET WALL RACK 5 PIECES

- 10" high carbon steel hand files
- Bi-material handle for a more comfortable grip
- 2nd cut to create a diamond pattern cutting surface for smoother filing
- Cut on both edges of the flat files for filing grooves, etc
- Supplied with a wall rack for fixing to the wall or a workbench

10" Files:
Flat, Hand, Half Round, Round, Three square

Item ID: **WRFL05**



10 Pieces

PUNCH & CHISEL SET WALL RACK 10 PIECES

- Flat cold chisel made from chrome molybdenum
- Pin punches made from chrome molybdenum
- Supplied with a wall rack for fixing to the wall or a workbench

Punches:		
Centre	Length: 150 mm	5 mm
Parallel	Length: 150 mm	3, 4, 5, 6, 7, 8 mm
Flat cold chisels::		
150 mm		Width: 19 mm
200 mm		Width: 25 mm
250 mm		Width: 25 mm

Item ID: **WRPC10**

SOCKET SETS

ALWAYS READY FOR ACTION

A good socket set is one of the most important things to have in your tool collection.

Do not try and get away with skimping to save some cash in the short term when choosing a socket set. You can guarantee that when you choose TengTools you will not be let down!



MECCA PRO™

SOCKET SETS IN DURABLE, SHOCKPROOF CASES

Secure lock system with click mechanism so you know the top is closed properly

Hard-wearing hinge with metal pin for increased life

Retractable handle, especially designed for comfort and durability.

Clear layout makes it easier to see which tools are missing

Rubber feet to prevent the box from sliding and which protects against scratching

Fully recyclable packaging that helps the environment

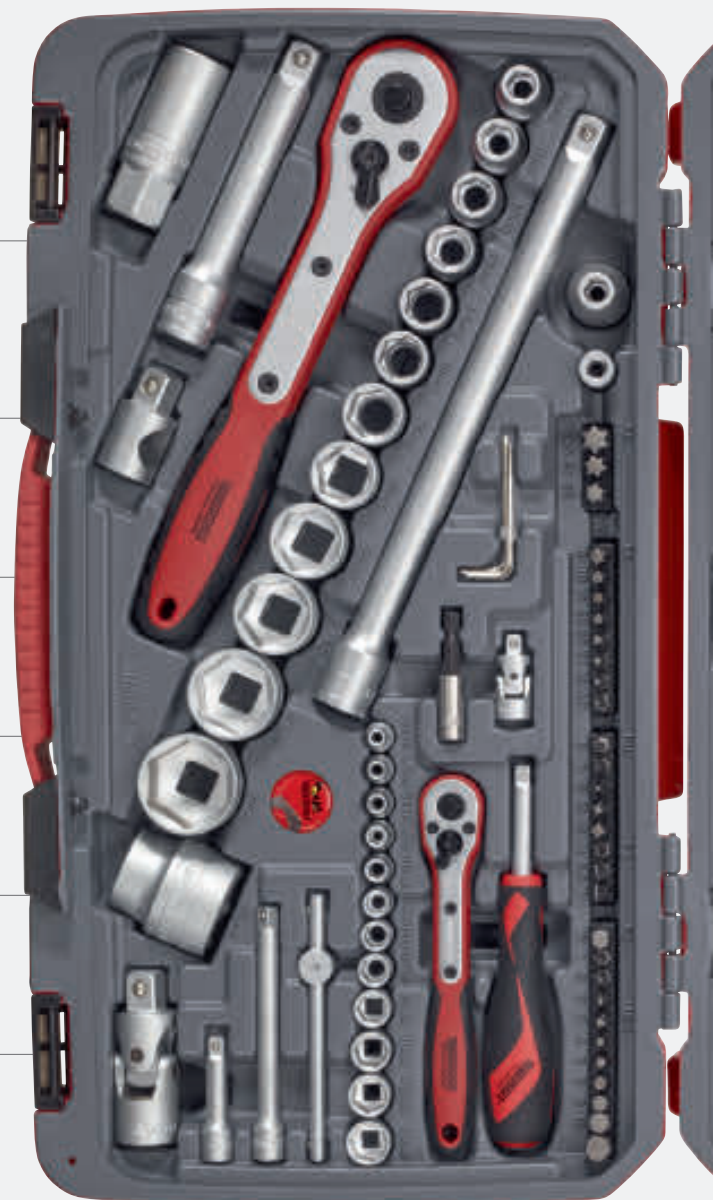

1/4" DRIVE



13 Pieces 1/4" mm

1/4" SOCKET SET 6 PT 13 PIECES

- A basic no nonsense set of 1/4" drive sockets
- Chrome vanadium
- Satin finish for a better grip when handling the socket
- 6 point single hexagon sockets for a better fit
- Ball bearing recess on the female end to grip the ratchet or power bar
- Designed and manufactured to DIN and ISO standards
- Supplied in a handy pocket sized holder with a clip rail facility for adding additional sockets or accessories

Flip Reverse Ratchet
2" Extension Bar
Regular 6 point sockets:
mm: 4 5 5.5 6 7 8
9 10 11 12 13

Item ID: M1413N1

CLIP RAIL FACILITY



15 Pieces 1/4" mm

1/4" SOCKET SET 6 PT WITH BELT CLIP

- Socket set that fits into the TTTJ04 tool tray allowing you to store 4 TJ sets in a single tray
- 1/4" drive stubby ratchet and accessories
- 1/4" drive sockets and a selection of bits

Stubby 72 teeth ratchet, 2" extension bar, 1/4"M x 1/4" Hex adaptor
Regular 6 point sockets:
mm: 5.5 6 7 8 10 12 13
1/4" Hex bits: Length 25mm
5.5 4, 5 PH1, PH2

Item ID: TJ1415



19 Pieces 1/4" mm

1/4" SOCKET SET 6 PT WITH BELT CLIP

- Socket set that fits into the TTTJ04 tool tray allowing you to store 4 TJ sets in a single tray
- 1/4" drive bits ratchet and accessories
- 1/4" drive sockets and a selection of bits

1/4" bits ratchet, 50mm magnetic bits holder, 1/4"M x 1/4" Hex adaptor
Regular 6 point sockets:
mm: 8 9 10 11 12 13
1/4" Hex bits: Length 25mm
4.5, 5.5, 6.5 PH1, PH2
PZ1, PZ2 4, 5, 6

Item ID: TJ1419



20 Pieces 1/4" mm

1/4" SOCKET SET 6 PT WITH BELT CLIP

- Socket set that fits into the TTTJ04 tool tray allowing you to store 4 TJ sets in a single tray
- 1/4" drive bits ratchet and accessories
- 1/4" drive sockets and a selection of bits

1/4" bits ratchet, 50mm magnetic bits holder, 1/4"M x 1/4" Hex adaptor
Regular 6 point sockets:
mm: 5.5 6 7 8 9 10 13
1/4" Hex bits: Length 25mm
4.5, 5.5, 6.5 PH1, PH2
PZ1, PZ2 TX10, TX15, TX20

Item ID: TJ1420



8 Pieces 1/4" mm

1/4" SOCKET SET 6 PT 8 PIECES

- Regular 6 point single hexagon sockets for a better grip
- Chrome vanadium satin finish sockets
- Supplied in the unique TengTools case with a snap lock
- Hard wearing hinge with a metal pin for longer life
- Designed and manufactured to DIN and ISO standards

Stubby 72 teeth ratchet
Regular 6 point sockets:
mm: 5.5 6 7 8 10 12 13

Item ID: T1408



19 Pieces 1/4" mm

1/4" SOCKET SET 6 PT 19 PIECES

- Regular 6 point single hexagon sockets for a better grip
- Chrome vanadium satin finish sockets
- A selection of screwdriver and hex bits
- Supplied in the unique TengTools case with a snap lock
- Hard wearing hinge with a metal pin for longer life
- Designed and manufactured to DIN and ISO standards

1/4" Mini bits ratchet
Magnetic bits holder, 1/4"M x 1/4" Hex adaptor
Regular 6 point sockets:
mm: 8 9 10 11 12 13
1/4" Hex bits:
4.5, 5.5, 6.5 4, 5, 6
PH1, PH2 PZ1, PZ2

Item ID: T1419



20 Pieces 1/4" mm

1/4" SOCKET SET 6 PT 20 PIECES

- Regular 6 point single hexagon sockets for a better grip
- Chrome vanadium satin finish sockets
- A selection of screwdriver and TX bits
- Supplied in the unique TengTools case with a snap lock
- Hard wearing hinge with a metal pin for longer life
- Designed and manufactured to DIN and ISO standards

1/4" Mini bits ratchet	
Magnetic bits holder, 1/4"M x 1/4" Hex adaptor	
Regular 6 point sockets:	
mm:	5.5 6 7 8 9 10 13
1/4" Hex bits:	4, 5.5, 6.5 TX10, TX15, TX20
	PH1, PH2 PZ1, PZ2

Item ID: T1420



23 Pieces 1/4" mm

1/4" SOCKET SET 6 PT 23 PIECES

- Regular 6 point single hexagon sockets for a better grip
- Chrome vanadium satin finish sockets
- A 4" adjustable wrench and a selection of bits
- Supplied in the unique TengTools case with a snap lock
- Hard wearing hinge with a metal pin for longer life
- Designed and manufactured to DIN and ISO standards

1/4" Mini bits ratchet	
4" Adjustable wrench, 1/4"M x 1/4" Hex adaptor, 2" Extension bar	
Regular 6 point sockets:	
mm:	4 5 5.5 6 7 8 10 12 13
1/4" Hex bits:	4, 5.5, 6.5 TX10, TX15, TX20
	PH1, PH2 PZ1, PZ2

Item ID: T1423



22 Pieces 1/4" mm

1/4" SOCKET SET 6 PT 22 PIECES

- Regular 6 point single hexagon sockets for a better grip
- Chrome vanadium satin finish sockets
- A selection of screwdriver and TX bits
- Supplied in the unique TengTools case with a snap lock
- Hard wearing hinge with a metal pin for longer life
- Designed and manufactured to DIN and ISO standards

72 Teeth ratchet	
Coupler adaptor, 2" Extension bar	
Regular 6 point sockets:	
mm:	4 5 5.5 6 7 8 10 12 13
1/4" Hex bits:	4, 5.5, 6.5 TX10, TX15, TX20
	PH1, PH2 PZ1, PZ2

Item ID: T1422



24 Pieces 1/4" mm

1/4" SOCKET SET 6 PT 24 PIECES

- Regular 6 point single hexagon sockets for a better grip
- Chrome vanadium satin finish sockets
- A selection of screwdriver, hex and TX bits
- Supplied in the unique TengTools case with a snap lock
- Hard wearing hinge with a metal pin for longer life
- Designed and manufactured to DIN and ISO standards

Flip reverse ratchet	
3" Extension bar, Universal Joint, Bits holder	
Regular 6 point sockets:	
mm:	4 5 5.5 6 7 8 10 11 12 13
1/4" Hex bits:	4, 5.5 TX10, TX15, TX20
	PH1, PH2 3, 5, 6

Item ID: T1424



24 Pieces 1/4" mm

1/4" SOCKET SET FLEXIBLE RATCHET 6 PT

- Regular 6 point single hexagon sockets for a better grip
- Chrome vanadium satin finish sockets
- A selection of screwdriver, hex and TX bits
- Supplied in the unique TengTools case with a snap lock
- Hard wearing hinge with a metal pin for longer life
- Designed and manufactured to DIN and ISO standards

72 Teeth flexible ratchet	
3" Extension bar, Universal Joint, Coupler adaptor	
Regular 6 point sockets:	
mm:	4 5 5.5 6 7 8 10 11 12 13
1/4" Hex bits:	4, 5.5 TX10, TX15, TX20
	PH1, PH2 3, 5, 6

Item ID: T1424S



35 Pieces 1/4" AF

1/4" SOCKET SET 6 PT AF 35 PIECES

- Regular and deep 6 point single hexagon sockets
- Chrome vanadium satin finish sockets
- A selection of screwdriver, hex and TX bits
- Supplied in the unique TengTools case with a snap lock
- Hard wearing hinge with a metal pin for longer life
- Designed and manufactured to DIN and ISO standards

Flip reverse ratchet, Universal Joint, Hex Keys: 1.5, 2 & 2.5mm	
Coupler adaptor, 2" & 4" Extension bars, 3/8" F x 1/4" M T-bar adaptor	
6 point sockets:	
Reg AF:	3/16 7/32 1/4 9/32 5/16 11/32 3/8 7/16 1/2
Deep AF:	3/16 1/4 5/16 3/8 7/16 1/2
1/4" Hex bits:	4, 5.5 TX10, TX15, TX20 5, 6
	PH1, PH2 PZ1, PZ2

Item ID: T1435AF





36 Pieces 1/4" mm

1/4" SOCKET SET 6 PT 36 PIECES

- Regular and deep 6 point single hexagon sockets for a better grip
- Chrome vanadium satin finish sockets
- A selection of screwdriver, hex and TX bits
- Supplied in the unique TengTools case with a snap lock
- Hard wearing hinge with a metal pin for longer life
- Designed and manufactured to DIN and ISO standards

Flip reverse ratchet, Universal Joint, Hex Keys: 1.5, 2 & 2.5mm	
Coupler adaptor, 2" & 4" Extension bars, 3/8" F x 1/4" M T-bar adaptor	
6 point sockets:	
Reg mm:	4 5 5.5 6 7 8 10 11 12 13
Deep mm:	6 7 8 10 12 13
1/4" Hex bits:	4, 5.5 TX10, TX15, TX20 5, 6 PH1, PH2 PZ1, PZ2

Item ID: **T1436**

MECCA PRO™



60 Pieces 1/4" mm AF

MECCA PRO 1/4" SOCKET SET 6 PT 60 PIECES

- Regular and deep 6 point single hexagon sockets for a better grip
- Chrome vanadium satin finish sockets
- A selection of screwdriver, hex and TX bits
- Supplied in the unique TengTools carrying case
- Hard wearing case with distinctive branding
- Tools clearly laid out to easily identify which tool belongs where
- Designed and manufactured to DIN and ISO standards

Flip reverse ratchet, Universal Joint, Spinner handle	
Coupler adaptor, 2" & 4" Extension bars, 3/8" F x 1/4" M T-bar adaptor	
6 point sockets:	
Reg mm:	4 4.5 5 5.5 6 7 8 9 10 11 12 13
Reg AF:	3/16 7/32 1/4 9/32 5/16 11/32 3/8 7/16 1/2
Deep mm:	6 7 8 10 12 13
Deep AF:	1/4 5/16 3/8 7/16 1/2
1/4" drive bit sockets:	
mm:	4 5.5 7
TX:	10 15 20 25 27
PH:	1 2
1/4" Hex bits:	4, 5.5 5, 6 PH1, PH2 PZ1, PZ2

Item ID: **T1460**



TT SERIES 35 Pieces 1/4" mm

1/4" SOCKET SET 6 PT TTI 35 PIECES

- Regular and deep 6 point single hexagon sockets
- Chrome vanadium satin finish sockets
- Designed and manufactured to DIN and ISO standards

72 Teeth ratchet, Universal Joint, 6" spinner handle	
Coupler adaptor, 2" & 4" Extension bars, 3/8" F x 1/4" M T-bar adaptor	
6 point sockets:	
Reg mm:	4 5 5.5 6 7 8 9 10 11 12 13
Deep mm:	6 7 8 10 12 13
1/4" Hex bits:	4, 5.5 TPX10, TPX15, TPX20 5, 6 PH1, PH2 PZ1, PZ2

Item ID: **TTI435**



TT SERIES 48 Pieces 1/4" mm

1/4" SOCKET & BITS SET TTI 48 PIECES

- Gearless palm ratchet, 3" extension bar
- 1/4" drive regular 6 point sockets 5-13mm
- A selection of 25mm & 89mm long bits

Gearless palm ratchet, 3" extension bar	
6 point sockets:	
Reg mm:	5 5.5 6 7 8 9 10 11 11 12 13
1/4" Hex bits: Length 25mm	3, 5, 5.5, 8 PH1, PH2, PH3 TPX20, TPX25, TPX30 2, 3, 4, 5, 6, 8 TX10, TX15, TX20, TX25, TX30, TX40 RO1, 2, 3
1/4" Hex bits: Length 89mm	3, 4 PH1, PH2 PZ1, PZ2 TX10, TX20, TX25

Item ID: **TTI448**



TT SERIES 35 Pieces 1/4" mm

1/4" SOCKET SET 12 PT TTI 35 PIECES

- Regular and deep 12 point bi-hexagon sockets
- Chrome vanadium satin finish sockets
- Designed and manufactured to DIN and ISO standards

72 Teeth ratchet, Universal Joint, 6" spinner handle	
Coupler adaptor, 2" & 4" Extension bars, 3/8" F x 1/4" M T-bar adaptor	
12 point sockets:	
Reg mm:	4 5 5.5 6 7 8 9 10 11 12 13
Deep mm:	6 7 8 10 12 13
1/4" Hex bits:	4, 5.5 TPX10, TPX15, TPX20 5, 6 PH1, PH2 PZ1, PZ2

Item ID: **TTI43512**



FOAM SERIES



87 Pieces 1/4" mm AF

1/4" SOCKET & BITS SET FOAM1 87 PIECES

- Gearless palm ratchet, accessories and a bi-flex wrench
- 1/4" drive regular 6 point sockets in metric and AF
- 1/4" drive deep 6 point sockets
- A selection of 25mm long bits

Gearless palm ratchet, 3" extension bar, 1/4"M x 1/4"Hex adaptor, Bi Flex wrench	
6 point sockets:	
Reg mm:	5.5 6 7 8 9 10 11 12 13
Reg AF:	1/4" 5/16" 3/8"
Deep mm:	6 7 8 9 10 11 12 13
1/4" Hex bits: Length 25mm	3.5, 4, 4.5, 5.5 (x2), 6.5, 8 PZ1 (x3), PZ2 (x6), PZ3 PH1 (x3), PH2 (x6), PH3 2, 3, 4, 5, 6, 8 mm TX6, TX7, TX8, TX9, TX10, TX15, TX20(x3), TX25(x3), TX27, TX30, TX40 TPX10, TPX15, TPX20 (x2), TPX25 (x2), TPX27, TPX30, TPX40 ROB1, 2, 3 PH2G

Item ID: **TEA1487**



FOAM SERIES



89 Pieces 1/4" mm

1/4" SOCKET SET 6 PT FOAM2 89 PIECES

- 1/4" drive regular and deep sockets
- A comprehensive range of 1/4" hex drive 25mm bits
- Supplied in the unique TengTools double width TC tray
- Tools are held in place using three colour pre-cut EVA foam clearly showing where each tool belongs
- Designed and manufactured to DIN and ISO standards

72 Teeth ratchet, Universal Joint, Spinner handle, 2" & 4" Extension bars	
Coupler adaptor, 3/8"F x 1/4"M T-bar adaptor, 1/4"M x 1/4" Hex adaptor	
6 point sockets:	
Reg mm:	4 5 5.5 6 7 8 9 10 11 12 13
Deep mm:	4 5 5.5 6 7 8 9 10 12 13
1/4" drive bit sockets:	
mm:	4 5.5 7
TX:	10 15 20 25 27 30 40
PZ:	1 2 3
PH:	0 1 2 3
1/4" Hex bits:	
	TX8, TX10, TX15, TX20, TX25, TX27, TX30
	TPX10, TPX15, TPX20, TPX25, TPX27, TPX30, TPX40
	PZ0, PZ1, PZ2, PZ3 PH0, PH1, PH2, PH3, PH4
	3, 4, 5, 6, 8, 10 1/8, 9/64, 5/32, 3/16, 1/4, 5/16
	3, 4, 5.5, 7 XZN: 5, 6

Item ID: **TED1489**



12 Pieces 1/4" mm

1/4" SOCKET CLIP RAIL SET 6 PT 12 PIECES

- 6 point single hexagon socket for a better grip
- Chrome vanadium
- Satin finish for a better grip when handling the socket
- Ball bearing recess on the female end to grip the ratchet
- Clip rail with socket clips for easy storage as a set
- Designed and manufactured to DIN3120/3124 and ISO2725

Clip rail (Length 185mm), 1/4" drive socket clips x12	
Regular 6 point sockets:	
mm:	4 4.5 5 5.5 6 7 8 9 10 11 12 13

Item ID: **M1412**



9 Pieces 1/4" mm

1/4" DEEP SOCKET CLIP RAIL SET 6 PT 9 PIECES

- Long sockets for extra reach
- Chrome vanadium
- Satin finish for a better grip when handling the socket
- 6 point single hexagon socket for a better grip
- Ball bearing recess on the female end to grip the ratchet
- Clip rail with socket clips for easy storage as a set
- Designed and manufactured to DIN3120/3124 and ISO2725

Clip rail (Length 165mm), 1/4" drive socket clips x9	
Deep 6 point sockets:	
mm:	4 5 6 7 8 9 10 12 13

Item ID: **M1407**



7 Pieces 1/4"

1/4" TX BIT SOCKET CLIP RAIL SET 8 PIECES

- All the most commonly used sizes in one handy set
- Chrome vanadium
- S2 steel bits pressed in to the socket
- Satin finish for a better grip when handling the socket
- Designed for use with TX fastenings
- Clip rail with socket clips for easy storage as a set

Clip rail (Length 110mm), 1/4" drive socket clips x7	
TX bit sockets:	
TX:	10 15 20 25 27 30 40

Item ID: **M1408TX**

3/8" DRIVE



CLIP RAIL FACILITY

12 Pieces 3/8" mm

3/8" SOCKET SET 6 PT 12 PIECES

- A basic no nonsense set of 3/8" drive sockets
- Chrome vanadium
- 6 point single hexagon sockets for a better fit
- Ball bearing recess on the female end to grip the ratchet
- Designed and manufactured to DIN and ISO standards
- Supplied in a handy pocket sized holder with a clip rail facility for adding additional sockets or accessories

Flip Reverse Ratchet, 3" Extension Bar						
Regular 6 point sockets:						
mm:	8	10	11	12	13	14
	15	16	17	19		

Item ID: M3812N1



34 Pieces 3/8" mm

3/8" SOCKET SET 6 PT 34 PIECES

- Regular 6 point single hexagon sockets for a better grip
- Chrome vanadium satin finish sockets
- A selection of screwdriver, hex and TX bits
- Supplied in the unique TengTools case with a snap lock
- Hard wearing hinge with a metal pin for longer life
- Designed and manufactured to DIN and ISO standards

Flip Reverse Ratchet, 3" & 6" Extension Bars						
Coupler adaptor, 1/2" F x 3/8" M T-bar adaptor						
Regular 6 point sockets:						
mm:	8	10	11	12	13	14 15 17 19
1/4" Hex bits:	3, 4, 5.5				TX10, TX15, TX20, TX25, TX27, TX30, TX40	
	PH1, PH2, PH3			PZ1, PZ2, PZ3		3, 4, 5, 6

Item ID: T3834



34 Pieces 3/8" mm

3/8" SOCKET SET FLEXIBLE RATCHET 6 PT

- Includes the TengTools stubby flex head ratchet
- Regular 6 point single hexagon sockets for a better grip
- Chrome vanadium satin finish sockets
- A selection of screwdriver, hex and TX bits
- Supplied in the unique TengTools case with a snap lock
- Designed and manufactured to DIN and ISO standards

72 Teeth flexible head ratchet, 3" & 6" Extension Bars						
Coupler adaptor, 1/2" F x 3/8" M T-bar adaptor						
Regular 6 point sockets:						
mm:	8	10	11	12	13	14 15 17 19
1/4" Hex bits:	3, 4, 5.5				TX10, TX15, TX20, TX25, TX27, TX30, TX40	
	PH1, PH2, PH3			PZ1, PZ2, PZ3		3, 4, 5, 6

Item ID: T3834S

MECCA PRO



35 Pieces 3/8" AF

MECCA PRO 3/8" SOCKET SET 6 PT AF 35 PIECES

- Regular and deep 6 point single hexagon sockets for a better grip
- Chrome vanadium satin finish sockets
- A selection of screwdriver, hex and TX bits
- Hard wearing case with distinctive branding
- Tools clearly laid out to easily identify which tool belongs where
- Designed and manufactured to DIN and ISO standards

Flip reverse ratchet, Universal joint, 4" & 6" Extension Bars										
Coupler adaptor, 1/2" F x 3/8" M T-bar adaptor										
6 point sockets:										
Reg AF:	5/16	3/8	7/16	1/2	9/16	5/8	11/16	3/4	13/16	7/8
Deep AF:	3/8	7/16	1/2	9/16	11/16	3/4				
Spark Plug Sockets mm: 16 21										
1/4" Hex bits:	4, 5.5					TX10, TX15, TX20			5, 6	
	PH1, PH2					PZ1, PZ2				

Item ID: T3835AF



MECCA PRO™



39 Pieces 3/8" mm

MECCA PRO 3/8" SOCKET SET 6 PT 39 PIECES

- Regular and deep 6 point single hexagon sockets for a better grip
- Chrome vanadium satin finish sockets
- A selection of screwdriver, hex and TX bits
- Hard wearing case with distinctive branding
- Tools clearly laid out to easily identify which tool belongs where
- Designed and manufactured to DIN and ISO standards

Flip reverse ratchet, Universal joint, 3" Wobble extension bar, 6" Extension Bar

Coupler adaptor, 1/2" F x 3/8" M T-bar adaptor

6 point sockets:

Reg mm:	8	9	10	11	12	13	14	15	16	17	
	18	19	21	22							

Deep mm:	8	10	12	13	17	19
----------	---	----	----	----	----	----

Spark Plug Sockets mm: 16 21

1/4" Hex bits:	4, 5.5	TX10, TX15, TX20	5, 6
	PH1, PH2	PZ1, PZ2	

Item ID: T3839

MECCA PRO™



39 Pieces 3/8" mm

MECCA PRO 3/8" SOCKET & TOOL SET 39 PIECES

- Regular and 6 point single hexagon sockets for a better grip
- Combination spanners
- Chrome vanadium satin finish sockets and spanners
- A selection of screwdriver, hex and TX bits
- Hard wearing case with distinctive branding
- Tools clearly laid out to easily identify which tool belongs where
- Designed and manufactured to DIN and ISO standards

Flip reverse ratchet, Universal joint, 6" Extension Bar

Coupler adaptor, 1/2" F x 3/8" M T-bar adaptor

Regular 6 point sockets:

mm:	8	9	10	11	12	13	14	15	16	17	
	18	19	21	22							

Combination Spanners: 8, 10, 11, 12, 13, 14, 15, 17, 19 mm

1/4" Hex bits:	4, 5.5	TX10, TX15, TX20	5, 6
	PH1, PH2	PZ1, PZ2	

Item ID: T3840

MECCA PRO™



48 Pieces 3/8" mm AF

MECCA PRO 3/8" SOCKET & TOOL SET MM/AF

- Regular 6 point single hexagon sockets for a better grip
- A range of combination spanners together with an adjustable wrench, power grip plier, pliers and screwdrivers
- Chrome vanadium satin finish sockets and spanners
- Hard wearing case with distinctive branding
- Tools clearly laid out to easily identify which tool belongs where
- Designed and manufactured to DIN and ISO standards

Flip reverse ratchet, Universal Joint, 3" & 6" Extension bars

Coupler adaptor, 1/2" F x 3/8" M T-bar adaptor

Regular 6 point sockets:

mm:	8	10	12	13	14	15	16	17	18	
	19	21								

AF:	7/16	1/2	9/16	11/16
-----	------	-----	------	-------

Spark Plug Sockets mm: 16 21

Combination Spanners: 8, 10, 12, 13, 14, 15, 16, 17, 18, 19 mm

7/16", 1/2", 9/16", 11/16"

Screwdrivers:	3	5.5	6.5	PH0	PH1	PH2
---------------	---	-----	-----	-----	-----	-----

Pliers: 6" Side Cutters, 7" Combination, 8" Long Nose, 10" Water Pump

Power Grip Pliers: 7" Curved jaw

Adjustable Wrench: 8" Phosphate Finish

Item ID: T3848

MECCA PRO™



67 Pieces 3/8" mm

MECCA PRO 3/8" SOCKET & TOOL SET 67 PIECES

- Regular 6 point single hexagon sockets for a better grip
- A range of combination spanners, pliers and screwdrivers
- Chrome vanadium satin finish sockets and spanners
- A selection of screwdriver, hex and TX bits
- Hard wearing case with distinctive branding
- Tools clearly laid out to easily identify which tool belongs where
- Designed and manufactured to DIN and ISO standards

Flip reverse ratchet, 3" & 6" Extension bars, Bits driver, Magnetic bits holder

Coupler adaptor, 1/2" F x 3/8" M T-bar adaptor

Regular 6 point sockets:

mm:	8	9	10	11	12	13	14	15	16	
	17	18	19	20	22					

Combination Spanners: 8, 10, 11, 12, 13, 14, 15, 16, 17, 19 mm

Screwdrivers:	3	5.5	6.5	PH0	PH1	PH2
---------------	---	-----	-----	-----	-----	-----

Pliers: 6" Side Cutters, 7" Combination, 8" Long Nose, 10" Water Pump

1/4" Hex bits: TX8, TX10, TX15, TX20, TX25, TX27, TX30, TX40, TX45, TX50

	3, 4, 5, 6, 8, 10	PH0, PH1, PH2, PH3
--	-------------------	--------------------

	4, 5.5, 7	PZ1, PZ2, PZ3
--	-----------	---------------

Item ID: T3867

MECCA PRO™



79 Pieces 3/8" mm

MECCA PRO 3/8" SOCKET & TOOL SET

- Regular 6 point single hexagon sockets for a better grip
- Combination spanners, adjustable wrench, a hex key set, LED light, utility knife, hook and pick set, measuring tape, gun saw, claw hammer, magnetic pick up, pliers and screwdrivers
- Chrome vanadium satin finish sockets and spanners
- Hard wearing case with distinctive branding
- Tools clearly laid out to easily identify which tool belongs where
- Designed and manufactured to DIN and ISO standards

Flip reverse ratchet, 5" Extension bar, Universal Joint, Bits driver, Magnetic bits holder

Coupler adaptor, 1/2" F x 3/8" M T-bar adaptor

Regular 6 point sockets:

mm:	8	10	11	12	13	14	15	17	19
	20	21	22						

LED Light with clip, 5m Measuring tape, Utility knife, Telescopic magnet, Gun saw, Hook & pick set, 16oz claw hammer, Folding hex key set, 8" wide jaw adjustable wrench

Combination Spanners: 6, 7, 8, 10, 11 mm

Screwdrivers: 3 5.5 6.5 PH1 PH2

Pliers: 6" Side Cutters, 7" Combination, 8" Long Nose, 10" Water Pump

1/4" Hex bits: TX10, TX15, TX20, TX25, TX27, TX30, TX40 4.5, 5.5, 6.5 TPX20, TPX25, TPX30 PH1, PH2, PH3, PH2G (x2) 4, 5, 6 PZ1, PZ2, PZ3 1, 2, 3

Item ID: TM079

MECCA PRO™



79 Pieces 3/8" mm

MECCA PRO 3/8" SOCKET & TOOL SET E

- Regular 6 point single hexagon sockets for a better grip
- Combination spanners, adjustable wrench, a hex key set, LED light, utility knife, hook and pick set, measuring tape, gun saw, engineers hammer, magnetic pick up, pliers and screwdrivers
- Chrome vanadium satin finish sockets and spanners
- Hard wearing case with distinctive branding
- Tools clearly laid out to easily identify which tool belongs where
- Designed and manufactured to DIN and ISO standards

Flip reverse ratchet, 5" Extension bar, Universal Joint, Bits driver, Magnetic bits holder

Coupler adaptor, 1/2" F x 3/8" M T-bar adaptor

Regular 6 point sockets:

mm:	8	10	11	12	13	14	15	17	19
	20	21	22						

LED Light with clip, 5m Measuring tape, Utility knife, Telescopic magnet, Gun saw, Hook & pick set, 500g Engineers hammer, Folding hex key set, 8" wide jaw adjustable wrench

Combination Spanners: 6, 7, 8, 10, 11 mm

Screwdrivers: 3 5.5 6.5 PH1 PH2

Pliers: 6" Side Cutters, 7" Combination, 8" Long Nose, 10" Water Pump

1/4" Hex bits: TX10, TX15, TX20, TX25, TX27, TX30, TX40 4.5, 5.5, 6.5 TPX20, TPX25, TPX30 PH1, PH2, PH3, PH2G (x2) 4, 5, 6 PZ1, PZ2, PZ3 1, 2, 3

Item ID: TM079E



TT SERIES 19 Pieces 3/8" mm

3/8" SOCKET SET 6 PT TTI 19 PIECES

- Regular 6 point single hexagon sockets
- Chrome vanadium satin finish sockets
- Designed and manufactured to DIN and ISO standards

72 Teeth ratchet, Universal Joint, 3" Wobble extension bar, 10" Spinner handle

Coupler adaptor, 1/2" F x 3/8" M T-bar adaptor

Regular 6 point sockets:

mm:	8	9	10	11	12	13	14	15	16
	17	18	19	22					

Item ID: TT3819



TT SERIES 32 Pieces 1/4" 3/8" AF

1/4" & 3/8" SOCKET SET AF 6 PT TTI

- Regular and deep 6 point single hexagon sockets
- Chrome vanadium satin finish sockets
- Designed and manufactured to DIN3120/3124 and ISO2725

3/8" Drive 6 point sockets:

Reg AF: 3/8 7/16 1/2 9/16 5/8 11/16 3/4

Deep AF: 3/8 7/16 1/2 9/16 5/8 11/16 3/4

1/4" Drive 6 point sockets:

Reg AF: 3/16 7/32 1/4 9/32 5/16 11/32 3/8 7/16 1/2

Deep AF: 3/16 7/32 1/4 9/32 5/16 11/32 3/8 7/16 1/2

Item ID: TTAF32



TT SERIES 19 Pieces 3/8" mm

3/8" SOCKET SET 12 PT TTI 19 PIECES

- Regular 12 point bi-hexagon sockets
- Chrome vanadium satin finish sockets
- Designed and manufactured to DIN and ISO standards

72 Teeth ratchet, Universal Joint, 3" Wobble extension bar, 10" Spinner handle

Coupler adaptor, 1/2" F x 3/8" M T-bar adaptor

Regular 12 point sockets:

mm:	8	9	10	11	12	13	14	15	16
	17	18	19	22					

Item ID: TT381912



TT SERIES 32 Pieces 1/4" 3/8" AF

1/4" & 3/8" SOCKET SET 12 PT AF TTI

- Regular and deep 12 point bi-hexagon sockets
- Chrome vanadium satin finish sockets
- Designed and manufactured to DIN3120/3124 and ISO2725

3/8" Drive 6 point sockets:

Reg AF: 3/8 7/16 1/2 9/16 5/8 11/16 3/4

Deep AF: 3/8 7/16 1/2 9/16 5/8 11/16 3/4

1/4" Drive 6 point sockets:

Reg AF: 3/16 7/32 1/4 9/32 5/16 11/32 3/8 7/16 1/2

Deep AF: 3/16 7/32 1/4 9/32 5/16 11/32 3/8 7/16 1/2

Item ID: TTAF3212



TT SERIES



16 Pieces 3/8" mm

3/8" SOCKET SET 6 PT TTI 16 PIECES

- Deep 6 point single hexagon sockets
- Chrome vanadium satin finish sockets
- Designed and manufactured to DIN3120/3124 and ISO2725

Deep 6 point sockets:

mm:	7	8	9	10	11	12	13	14	15
	16	17	18	19	20	21	22		

Item ID: **TT3816**



TT SERIES



16 Pieces 3/8" mm

3/8" SOCKET SET 12 PT TTI 16 PIECES

- Deep 12 point bi-hexagon sockets
- Chrome vanadium satin finish sockets
- Designed and manufactured to DIN3120/3124 and ISO2725

Deep 12 point sockets:

mm:	7	8	9	10	11	12	13	14	15
	16	17	18	19	20	21	22		

Item ID: **TT381612**



TT SERIES



30 Pieces 1/4" 3/8"

3/8" TX BIT SOCKET SET TTI 30 PIECES

- Chrome vanadium satin finish sockets
- Designed and manufactured to DIN and ISO standards

3" Extension bar, 3/8"F x 1/4"M adaptor

3/8" Drive bit sockets:

TX:	10	15	20	25	27	30	40	45	50
TPX:	10	15	20	25	27	30	40	45	50
TX-E:	E10	E12	E14	E16	E18				

1/4" Drive bit sockets:

TX-E:	E4	E5	E6	E7	E8
-------	----	----	----	----	----

Item ID: **TTTX30**



TT SERIES



35 Pieces 1/4" 3/8"

1/4" & 3/8" BIT SOCKET SET TTI 35 PIECES

- Includes all the most commonly used screwdriver, hex and TX bits
- Chrome vanadium satin finish sockets

3/8"F x 1/4"M adaptor, 1/4"F x 3/8"M adaptor

1/4" Drive bit sockets:

TX:	10	15	20	25	27	30	40
mm:	4	4.5	7				
PH:	0	1	2	3			
PZ:	1	2	3				

3/8" Drive bit sockets:

mm:	3	4	5	5.5	6	7	8	10	12
AF:	1/8	5/32	3/16	7/32	1/4	5/16	3/8		

Item ID: **TTBS35**



FOAM SERIES



36 Pieces 3/8" mm

3/8" SOCKET SET 6 PT FOAM2 36 PIECES

- 3/8" drive regular length sockets
- A range of 3/8" drive bits sockets covering hex and TX sizes
- Tools are held in place using three colour pre-cut EVA foam clearly showing where each tool belongs
- Designed and manufactured to DIN and ISO standards

72 Teeth ratchet, Universal Joint, 3" Wobble extension bar,

1/2"F x 3/8"M T-bar adaptor, 10" Spinner handle

Regular 6 point sockets:

mm:	8	9	10	11	12	13	14	15	16
	17	18	19	22					

3/8" Drive bit sockets:

TX:	10	15	20	25	27	30	40	45	50
mm:	3	4	5	5.5	6	7	8	10	12

Item ID: **TED3836**



16 Pieces 3/8" mm

3/8" SOCKET CLIP RAIL SET 6 PT 16 PIECES

- 6 point single hexagon socket for a better grip
- Chrome vanadium
- Satin finish for a better grip when handling the socket
- Ball bearing recess on the female end to grip the ratchet
- Supplied with a clip rail with socket clips for easy storage as a set
- Designed and manufactured to DIN3120/3124 and ISO2725

Clip rail (Length: 370mm), 3/8" Drive socket clips x16

Regular 6 point sockets:

mm:	7	8	9	10	11	12	13	14
	15	16	17	18	19	20	21	22

Item ID: **M3816**



7 Pieces 3/8" mm

3/8" DEEP SOCKET CLIP RAIL SET 6 PT 7 PIECES

- Long sockets for extra reach
- Chrome vanadium
- Satin finish for a better grip when handling the socket
- 6 point single hexagon socket for a better grip
- Ball bearing recess on the female end to grip the ratchet
- Supplied with a clip rail with socket clips for easy storage as a set
- Designed and manufactured to DIN3120/3124 and ISO2725

Clip rail (Length: 165mm), 3/8" Drive socket clips x7

Deep 6 point sockets:

mm:	10	12	13	14	15	17	19
-----	----	----	----	----	----	----	----

Item ID: **M3807**



9 Pieces 3/8" mm

3/8" HEX BIT SOCKET CLIP RAIL SET 9 PIECES

- Chrome vanadium
- S2 steel bits pressed in to the socket
- Satin finish for a better grip when handling the socket
- Designed for use with fastenings with a hexagon hole
- Use with in-hex screws or grub screws
- Designed and manufactured to DIN7422
- Supplied with a clip rail with socket clips for easy storage as a set

Clip rail (Length: 165mm), 3/8" Drive socket clips x9

3/8" Drive Hex bit sockets - Length 49.5mm:

mm:	3	4	5	5.5	6	7	8	10	12
-----	---	---	---	-----	---	---	---	----	----

Item ID: **M3812**

NEW



9 Pieces 3/8" mm

3/8" HEX BIT SOCKET CLIP RAIL SET 100MM

- Chrome vanadium
- S2 steel bits pressed into the socket
- Satin finish for a better grip when handling the socket
- Ball recess on the female end to grip the ratchet
- Designed for use with fastenings with a hexagon hole
- Use with in-hex screws or grub screws
- Designed and manufactured to DIN7422
- Supplied on a metal clip rail

Clip rail (Length: 165mm), 3/8" Drive socket clips x9

3/8" Drive Hex bit sockets - Length 100mm:

mm:	3	4	5	5.5	6	7	8	10	12
-----	---	---	---	-----	---	---	---	----	----

Item ID: **M3809**



8 Pieces 3/8" AF

3/8" HEX BIT SOCKET CLIP RAIL SET AF

- Chrome vanadium
- S2 steel bits pressed in to the socket
- Satin finish for a better grip when handling the socket
- Designed for use with fastenings with a hexagon hole
- Use with in-hex screws or grub screws
- Supplied with a clip rail with socket clips for easy storage as a set

Clip rail (Length: 165mm), 3/8" Drive socket clips x8

3/8" Drive Hex bit sockets - Length 49.5mm:

AF:	3/32	1/8	5/32	3/16	7/32	1/4	5/16	3/8
-----	------	-----	------	------	------	-----	------	-----

Item ID: **M3811**



9 Pieces 3/8"

3/8" TPX BIT SOCKET CLIP RAIL SET 9 PIECES

- Chrome vanadium
- S2 steel bits pressed in to the socket
- Satin finish for a better grip when handling the socket
- Designed for use with tamper proof TX fastenings
- Supplied with a clip rail with socket clips for easy storage as a set

Clip rail (Length: 165mm), 3/8" Drive socket clips x9

3/8" Drive TPX bit sockets - Length 49.5mm:

TPX:	10	15	20	25	27	30	40	45	50
------	----	----	----	----	----	----	----	----	----

Item ID: **M3813TPX**

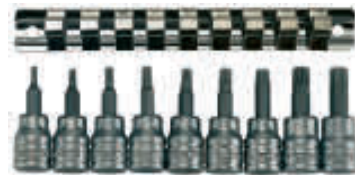

9 Pieces 3/8"

3/8" TX BIT SOCKET CLIP RAIL SET 9 PIECES

- Chrome vanadium
- S2 steel bits pressed in to the socket
- Satin finish for a better grip when handling the socket
- Designed for use with TX fastenings
- Supplied with a clip rail with socket clips for easy storage as a set

Clip rail (Length: 165mm), 3/8" Drive socket clips x9

3/8" Drive TX bit sockets - Length 49.5mm:

TX:	10	15	20	25	27	30	40	45	50
-----	----	----	----	----	----	----	----	----	----

Item ID: **M3813TX**

NEW



9 Pieces 3/8"

3/8" TX BIT SOCKET CLIP RAIL SET 100MM

- Chrome vanadium
- S2 steel bits pressed into the socket
- Satin finish for a better grip when handling the socket
- Ball recess on the female end to grip the ratchet
- Designed for use with fastenings with a TX hole
- Supplied on a metal clip rail

Clip rail (Length: 165mm), 3/8" Drive socket clips x9

3/8" Drive TX bit sockets - Length 100mm:

TX:	10	15	20	25	27	30	40	45	50
-----	----	----	----	----	----	----	----	----	----

Item ID: **M3809TX**



10 Pieces 1/4" 3/8"

1/4" & 3/8" TX-E SOCKET CLIP RAIL SET

- TX-E Clip rail set
- Chrome vanadium
- Ball bearing recess on the female end to grip the ratchet
- Designed for use with protruding TX head screws
- Supplied with a clip rail with socket clips for easy storage as a set

Clip rail (Length: 165mm), 3/8" Drive socket clips x5, 1/4" Drive socket clips x5

3/8" Drive TX-E bit sockets - Length 28mm:

TX-E:	E10	E12	E14	E16	E18
-------	-----	-----	-----	-----	-----

1/4" Drive bit sockets:

TX-E:	E4	E5	E6	E7	E8
-------	----	----	----	----	----

Item ID: **M3814**

NEW



6 Pieces 3/8"

3/8" RIBE BIT SOCKET CLIP RAIL SET 100MM

- Chrome vanadium
- S2 steel bits pressed into the socket
- Satin finish for a better grip when handling the socket
- Ball recess on the female end to grip the ratchet
- Designed for use with fastenings with a multi spline RIBE type hole
- Supplied on a metal clip

Clip rail (Length: 165mm), 3/8" Drive socket clips x6

3/8" Drive RIBE bit sockets - Length 100mm:

Ribe:	04	05	06	08	09	10
-------	----	----	----	----	----	----

Item ID: **M3806**



8 Pieces 3/8" mm

3/8" CROW FOOT WRENCH CLIP RAIL SET

- Open ended spanner at right angle to square drive
- Ideal for accessing confined spaces
- Use with a ratchet or torque wrench with an extension bar
- Satin finish chrome vanadium
- Supplied with a clip rail with socket clips for easy storage

3/8" Drive Crow Foot Wrenches

10, 11, 12, 13, 16, 17, 18, 19 mm

Item ID: **M3808MM**

1/2" DRIVE



12 Pieces 1/2" mm

1/2" SOCKET SET 12 PT 12 PIECES

- 12 point bi-hexagon sockets for easier alignment to the fastening
- Chrome vanadium
- Satin finish for a better grip when handling the socket
- Ball bearing recess on the female end to grip the ratchet
- Designed and manufactured to DIN and ISO standards
- Supplied in a handy pocket sized holder with a clip rail facility for adding additional sockets or accessories

Flip Reverse Ratchet, 5" Extension Bar	
Regular 12 point sockets:	
mm:	8 10 12 13 14 15 17 18 19 24

Item ID: M1212N1



20 Pieces 1/2" AF

MECCA PRO 1/2" SOCKET SET 12 PT AF

- 12 point bi-hexagon sockets for easier alignment to the fastening
- Chrome vanadium satin finish sockets
- Hard wearing case with distinctive branding
- Tools clearly laid out to easily identify which tool belongs where
- Designed and manufactured to DIN and ISO standards

Flip reverse ratchet, 2 1/2" & 6" Extension bars	
Universal joint, 3/8" F x 1/2" M T-bar adaptor	
Regular 12 point sockets:	
AF:	3/8 7/16 1/2 9/16 5/8 11/16 3/4 13/16 7/8 15/16 1 1-1/16 1-1/8 1-3/16 1-1/4

Item ID: T1220AF



21 Pieces 1/2" mm

MECCA PRO 1/2" SOCKET SET 12 PT 21 PIECES

- 12 point bi-hexagon sockets for easier alignment to the fastening
- Chrome vanadium satin finish sockets
- Hard wearing case with distinctive branding
- Tools clearly laid out to easily identify which tool belongs where
- Designed and manufactured to DIN and ISO standards

Flip reverse ratchet, 2 1/2" & 6" Extension bars	
Universal joint, 3/8" F x 1/2" M T-bar adaptor	
Regular 12 point sockets:	
mm:	10 11 12 13 14 15 16 17 18 19 21 22 24 27 30 32

Item ID: T1221



21 Pieces 1/2" mm

MECCA PRO 1/2" SOCKET SET 6 PT 21 PIECES

- 6 point single hexagon sockets for a better grip
- Chrome vanadium satin finish sockets
- Hard wearing case with distinctive branding
- Tools clearly laid out to easily identify which tool belongs where
- Designed and manufactured to DIN and ISO standards

Flip reverse ratchet, 2 1/2" & 6" Extension bars	
Universal joint, 3/8" F x 1/2" M T-bar adaptor	
Regular 12 point sockets:	
mm:	10 11 12 13 14 15 16 17 18 19 21 22 24 27 30 32

Item ID: T1221-6

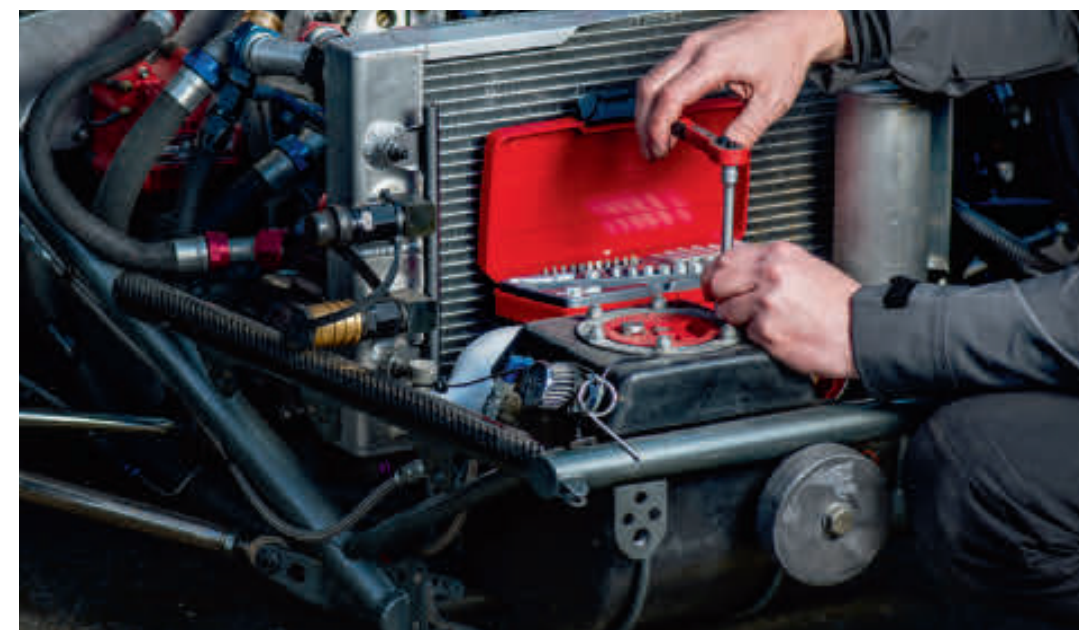

MECCA PRO™



30 Pieces 1/2" mm AF

MECCA PRO 1/2" SOCKET SET 12 PT MM/AF

- 12 point bi-hexagon sockets for easier alignment to the fastening
- Chrome vanadium satin finish sockets
- Hard wearing case with distinctive branding
- Tools clearly laid out to easily identify which tool belongs where
- Designed and manufactured to DIN and ISO standards

Flip reverse ratchet, 5" Extension bar											
Universal joint, 3/8"F x 1/2"M T-bar adaptor											
Regular 12 point sockets:											
AF:	3/8	7/16	1/2	9/16	5/8	3/4	13/16	15/16	1		
	1-1/8	1-1/4									
mm:	10	12	13	14	15	16	17	18	19		
	21	22	24	27	30	32					

Item ID: T1230

MECCA PRO™



34 Pieces 1/2" mm

MECCA PRO 1/2" SOCKET SET 6 PT 34 PIECES

- 6 point single hexagon sockets for a better grip
- Chrome vanadium satin finish sockets
- Hard wearing case with distinctive branding
- Tools clearly laid out to easily identify which tool belongs where
- Designed and manufactured to DIN and ISO standards

Flip reverse ratchet, 5" & 10" Extension bars												
Universal joint, 3/8"F x 1/2"M T-bar adaptor, Hex keys: 1.5, 2, 2.5mm												
6 point sockets:												
Reg mm:	10	11	12	13	14	15	16	17				
	18	19	20	21	22	23	24	27				
Deep mm:	13	14	15	16	17	18	19	24				
Spark plug sockets mm:	16	21										

Item ID: T1234

MECCA PRO™



44 Pieces 1/2" mm AF

MECCA PRO 1/2" SOCKET & TOOL SET MM/AF

- Regular and deep 12 point bi-hexagon sockets for easier alignment to the fastening
- Chrome vanadium satin finish sockets
- 10x13mm "Rigger Jigger" double ring spanner and screwdrivers
- Hard wearing case with distinctive branding
- Tools clearly laid out to easily identify which tool belongs where
- Designed and manufactured to DIN and ISO standards

Flip reverse ratchet, 17" Flex handle, 2 1/2", 5" & 10" Extension bars											
Universal joint, 3/8"F x 1/2"M T-bar adaptor											
Regular 12 point sockets:											
AF:	3/8	1/2	9/16	19/32	11/16	25/32	13/16	1			
mm:	10	11	12	13	14	15	16	17	18		
	19	20	21	22	23	24	27	30	32		
Deep 12 point sockets:											
mm:	10	13	17	19							
Spark plug sockets mm:	16	21									
Screwdrivers:	5.5	6.5	PZ1	PZ2							
Double ring spanner:	10 x 13mm (Rigger Jigger)										

Item ID: T1244

MECCA PRO™



68 Pieces 1/2" mm

MECCA PRO 1/2" SOCKET & TOOL SET 68 PIECES

- 12 point bi-hexagon sockets for easier alignment to the fastening
- A range of combination spanners, pliers and screwdrivers
- Chrome vanadium satin finish sockets and spanners
- Hard wearing case with distinctive branding
- Tools clearly laid out to easily identify which tool belongs where
- Designed and manufactured to DIN and ISO standards

Flip reverse ratchet, 2 1/2" & 6" Extension bars, Bits driver, Magnetic bits holder											
Universal joint, 3/8"F x 1/2"M T-bar adaptor											
Regular 12 point sockets:											
mm:	10	11	12	13	14	15	16	17	18		
	19	21	22	27	30	32					
Combination spanners:	8, 10, 11, 12, 13, 14, 15, 16, 17, 19 mm										
Screwdrivers:	3	5.5	6.5	PH0	PH1	PH2					
Pliers:	6" Side cutter, 7" Combination, 8" Long nose, 10" Water pump										
1/4" Hex bits:	TX8, TX10, TX15, TX20, TX25, TX27, TX30, TX40, TX45, TX50										
	3, 4, 5, 6, 8, 10	4, 5.5, 7	PZ1, PZ2, PZ3								
	PH0, PH1, PH2, PH3										

Item ID: T1268



TT SERIES
1

5 Pieces 1/2"

1/2" RATCHET & ACCESSORIES SET TTI 5 PIECES

- Socket accessory set
- Designed and manufactured to DIN and ISO standards

72 Teeth ratchet, 5" & 10" Extension bars
Universal joint, 3/8"F x 1/2"M T-bar adaptor

Item ID: TTI205



TT SERIES
1

11 Pieces 1/2" mm

1/2" DEEP SOCKET SET 12 PT TTI 11 PIECES

- Deep 12 point bi-hexagon sockets
- Includes a 10" flex handle with ergonomic grip
- Chrome vanadium satin finish
- Designed and manufactured to DIN and ISO standards

10" Flex handle
Deep 12 point sockets:
mm: 10 11 12 13 14 15
16 17 18 19

Item ID: TTI211



TT SERIES
1

17 Pieces 1/2" mm

1/2" SOCKET SET 6 PT TTI 17 PIECES

- 6 point single hexagon sockets
- Chrome vanadium satin finish sockets
- Designed and manufactured to DIN3120/3124 and ISO2725

Regular 6 point sockets:
mm: 10 11 12 13 14 15 16 17 18
19 20 21 22 24 27 30 32

Item ID: TTI217-6



TT SERIES
1

17 Pieces 1/2" mm

1/2" SOCKET SET 12 PT TTI 17 PIECES

- 12 point bi-hexagon sockets
- Chrome vanadium satin finish sockets
- Designed and manufactured to DIN3120/3124 and ISO2725

Regular 12 point sockets:
mm: 10 11 12 13 14 15 16 17 18
19 20 21 22 24 27 30 32

Item ID: TTI217



TT SERIES
1

18 Pieces 1/2" mm

1/2" SOCKET SET 6 PT TTI 18 PIECES

- 6 point single hexagon sockets
- Chrome vanadium satin finish sockets
- Designed and manufactured to DIN and ISO standards

72 Teeth ratchet, 2 1/2" & 10" Extension bars
Universal joint, 3/8"F x 1/2"M T-bar adaptor
Regular 6 point sockets:
mm: 10 11 12 13 14 15 16 17 18
19 22 24

Item ID: TTI218-6



TT SERIES
1

18 Pieces 1/2" mm

1/2" SOCKET SET 12 PT TTI 18 PIECES

- 12 point bi-hexagon sockets
- Chrome vanadium satin finish sockets
- Designed and manufactured to DIN and ISO standards

72 Teeth ratchet, 2 1/2" & 10" Extension bars
Universal joint, 3/8"F x 1/2"M T-bar adaptor
Regular 12 point sockets:
mm: 10 11 12 13 14 15 16 17 18
19 22 24

Item ID: TTI218



TT SERIES
1

15 Pieces 1/2" AF

1/2" SOCKET SET 12 PT AF TTI 15 PIECES

- 12 point bi-hexagon sockets
- Chrome vanadium satin finish sockets
- Designed and manufactured to DIN3120 and ASME B107.1

Regular 12 point sockets:
AF: 3/8 7/16 1/2 9/16 5/8 11/16 3/4 13/16 7/8
15/16 1 1-1/16 1-1/8 1-3/16 1-1/4

Item ID: TTI215AF



TT SERIES
1

16 Pieces 1/2" mm

1/2" HEX BIT SOCKET SET TTI 16 PIECES

- Chrome vanadium satin finish sockets
- Designed and manufactured to DIN7422

Hex bit sockets mm:
Length 55mm: 5 6 7 8 9 10 12 14 17
Length 100mm: 5 6 10 12 14 17
Length 115mm: 8

Item ID: TT HEX16



TT SERIES
1

23 Pieces 1/2" mm

1/2" HEX BIT SOCKET SET TTI 23 PIECES

- Chrome vanadium satin finish bit holders included
- Grub screws to retain the bit in place, especially useful when working in difficult to reach places
- Designed and manufactured to DIN 3126 & ISO 1173

10mm Hex bit adaptor, 12mm Hex bit adaptor, 2mm Hex mini screwdriver

Hex bit sockets mm:	
Length 40mm:	10mm Hex Drive: 5 6 7 8 9 10 12mm Hex Drive: 12 14 17 19
Length 75mm:	10mm Hex Drive: 5 6 7 8 9 10 12mm Hex Drive: 12 14 17 19

Item ID: **TTHEX23**



TT SERIES
1

23 Pieces 1/2" mm

1/2" TX BIT SOCKET SET TTI 23 PIECES

- Chrome vanadium satin finish bit holders included
- Grub screws to retain the bit in place, especially useful when working in difficult to reach places
- Designed and manufactured to DIN 3126 & ISO 1173

10mm Hex bit adaptor, 12mm Hex bit adaptor, 2mm Hex mini screwdriver

TX bit sockets:	
Length 40mm:	10mm Hex Drive: 20 25 27 30 40 45 50 55 12mm Hex Drive: 60 70
Length 75mm:	10mm Hex Drive: 20 25 27 30 40 45 50 55 12mm Hex Drive: 60 70

Item ID: **TTTX23**



TT SERIES
1

18 Pieces 1/2" mm

1/2" TX BIT SOCKET SET TTI 18 PIECES

- Chrome vanadium satin finish sockets
- Designed and manufactured to DIN and ISO standards

TX bit sockets:	
Length 55mm:	20 25 27 30 40 45 50 55 60
Length 110mm:	20 25 27 30 40 45 50 55 60

Item ID: **TTTX18**



TT SERIES
1

15 Pieces 1/2" mm

1/2" LONG HEX & TX BIT SOCKET SET TTI

- 100mm length for easier access in recesses
- Chrome vanadium satin finish sockets
- Designed and manufactured to DIN and ISO standards

TX bit sockets:	
Length 100mm:	20 25 27 30 40 45 50 55 60
Hex bit sockets mm:	
Length 100mm:	5 6 7 8 10 12

Item ID: **TTTXH15**



TT SERIES
1

15 Pieces 1/2" mm

1/2" LONG RIBE & XZN BIT SOCKET SET TTI

- 100mm length for easier access in recesses
- Chrome vanadium satin finish sockets
- Designed and manufactured to DIN and ISO standards

Ribe bit sockets:	
Length 100mm:	4 5 6 8 10 11 12 13
XZN bit sockets:	
Length 100mm:	5 6 8 10 12 14 16

Item ID: **TTRS15**



FOAM SERIES
2

27 Pieces 1/2" mm

1/2" SOCKET SET 12 PT FOAM2 27 PIECES

- 1/2" drive regular and deep sockets
- Supplied in the unique TengTools double width TC tray
- Tools are held in place using three colour pre-cut EVA foam clearly showing where each tool belongs
- Designed and manufactured to DIN and ISO standards

72 Teeth ratchet, 2 1/2" & 6" Extension bars	
Universal joint, 3/8" F x 1/2" M T-bar adaptor	
12 point sockets:	
Reg mm:	10 11 12 13 14 15 16 17 18 19 22 24
Deep mm:	10 11 12 13 14 15 16 17 18 19

Item ID: **TED1227**



15 Pieces 1/2" mm

1/2" SOCKET CLIP RAIL SET 12 PT 15 PIECES

- 12 point bi-hexagon socket for easier alignment to the fastening
- Chrome vanadium
- Satin finish for a better grip when handling the socket
- Ball bearing recess on the female end to grip the ratchet
- Supplied with a clip rail with socket clips for easy storage as a set
- Designed and manufactured to DIN3120/3124 and ISO2725

Clip rail (Length: 430mm), 1/2" Drive socket clips x15	
Regular 12 point sockets:	
mm:	10 12 13 14 15 16 17 18 19 21 22 24 27 30 32

Item ID: **M1215MM**



8 Pieces 1/2" mm

1/2" DEEP SOCKET CLIP RAIL SET 12 PT 8 PIECES

- Long sockets for extra reach
- Chrome vanadium
- Satin finish for a better grip when handling the socket
- 12 point bi-hexagon socket for easier alignment to the fastening
- Ball bearing recess on the female end to grip the ratchet
- Supplied with a clip rail with socket clips for easy storage as a set
- Designed and manufactured to DIN3120/3124 and ISO2725

Clip rail (Length: 210mm), 1/2" Drive socket clips x8	
Deep 12 point sockets:	
mm:	13 14 15 17 19 21 22 24

Item ID: **M1207**



15 Pieces 1/2" mm

1/2" SOCKET CLIP RAIL SET 12 PT AF 15 PIECES

- 12 point bi-hexagon socket for easier alignment to the fastening
- Chrome vanadium
- Satin finish for a better grip when handling the socket
- Ball bearing recess on the female end to grip the ratchet
- Supplied with a clip rail with socket clips for easy storage as a set
- Designed and manufactured to DIN3120/3124 and ISO2725

Clip rail (Length: 430mm), 1/2" Drive socket clips x15

Regular 12 point sockets:

AF:	3/8	7/16	1/2	9/16	5/8	11/16	3/4	13/16	7/8
	15/16	1	1-1/16	1-1/8	1-3/16	1-1/4			

Item ID: **M1215AF**



8 Pieces 1/2" mm

1/2" DEEP SOCKET CLIP RAIL SET 6 PT 8 PIECES

- Long sockets for extra reach
- Chrome vanadium
- Satin finish for a better grip when handling the socket
- 6 point single hexagon socket for a better grip
- Ball bearing recess on the female end to grip the ratchet
- Supplied with a clip rail with socket clips for easy storage as a set
- Designed and manufactured to DIN3120/3124 and ISO2725

Clip rail (Length: 210mm), 1/2" Drive socket clips x8

Deep 6 point sockets:

mm:	13	14	15	17	19	21	22	24
-----	----	----	----	----	----	----	----	----

Item ID: **M1208-6**



9 Pieces 1/2" mm

1/2" HEX BIT SOCKET CLIP RAIL SET 9 PIECES

- Chrome vanadium
- S2 steel bits pressed in to the socket
- Satin finish for a better grip when handling the socket
- Designed for use with fastenings with a hexagon hole
- Use with in-hex screws or grub screws
- Designed and manufactured to DIN7422
- Supplied with a clip rail with socket clips for easy storage as a set

Clip rail (Length: 220mm), 1/2" Drive socket clips x9

Hex bit sockets:

mm:	5	6	7	8	9	10	12	14	17
-----	---	---	---	---	---	----	----	----	----

Item ID: **M1212**



9 Pieces 1/2" AF

1/2" HEX BIT SOCKET CLIP RAIL SET AF

- Chrome vanadium
- S2 steel bits pressed in to the socket
- Satin finish for a better grip when handling the socket
- Designed for use with fastenings with a hexagon hole
- Use with in-hex screws or grub screws
- Designed and manufactured to DIN7422
- Supplied with a clip rail with socket clips for easy storage as a set

Clip rail (Length: 220mm), 1/2" Drive socket clips x9

Hex bit sockets:

AF:	3/16	7/32	1/4	9/32	5/16	3/8	1/2	9/16	5/8
-----	------	------	-----	------	------	-----	-----	------	-----

Item ID: **M1209AF**



6 Pieces 1/2" mm

1/2" LONG HEX BIT SOCKET CLIP RAIL SET

- Chrome vanadium
- 100mm long bits for reaching in to recesses
- S2 steel bits pressed in to the socket
- Satin finish for a better grip when handling the socket
- Designed for use with fastenings with a hexagon hole
- Use with in-hex screws or grub screws
- Designed and manufactured to DIN7422
- Supplied with a clip rail with socket clips for easy storage as a set

Clip rail (Length: 160mm), 1/2" Drive socket clips x6

Hex bit sockets (Length 100mm):

mm:	5	6	7	8	10	12
-----	---	---	---	---	----	----

Item ID: **M1211**



9 Pieces 1/2"

1/2" TX-E SOCKET CLIP RAIL SET 9 PIECES

- Chrome vanadium
- Satin finish for a better grip when handling the socket
- Ball bearing recess on the female end to grip the ratchet
- Designed for use with protruding TX head screws
- Supplied with a clip rail with socket clips for easy storage as a set

Clip rail (Length: 220mm), 1/2" Drive socket clips x9

TX-E bit sockets:

TX-E:	E10	E11	E12	E14	E16	E18	E20	E22	E24
-------	-----	-----	-----	-----	-----	-----	-----	-----	-----

Item ID: **M1210**



9 Pieces 1/2"

1/2" TPX BIT SOCKET CLIP RAIL SET

- Chrome vanadium
- S2 steel bits pressed in to the socket
- Satin finish for a better grip when handling the socket
- Designed for use with tamper proof TX fastenings
- Supplied with a clip rail with socket clips for easy storage as a set

Clip rail (Length: 220mm), 1/2" Drive socket clips x9

TPX bit sockets:

TPX:	20	25	27	30	40	45	50	55	60
------	----	----	----	----	----	----	----	----	----

Item ID: **M1213TPX**



9 Pieces 1/2"

1/2" TX BIT SOCKET CLIP RAIL SET 9 PIECES

- Chrome vanadium
- S2 steel bits pressed in to the socket
- Satin finish for a better grip when handling the socket
- Designed for use with TX fastenings
- Supplied with a clip rail with socket clips for easy storage as a set

Clip rail (Length: 220mm), 1/2" Drive socket clips x9

TX bit sockets:

TX:	20	25	27	30	40	45	50	55	60
-----	----	----	----	----	----	----	----	----	----

Item ID: **M1213TX**

NEW



9 Pieces 1/2"

1/2" TX BIT SOCKET CLIP RAIL SET 100MM

- Chrome vanadium
- S2 steel bits pressed into the socket
- Satin finish for a better grip when handling the socket
- Ball recess on the female end to grip the ratchet
- Designed for use with fastenings with a TX hole
- Supplied on a metal clip rail

Clip rail (Length: 220mm), 1/2" Drive socket clips x9										
TX bit sockets (Length 100mm):										
<table border="1"> <tr> <td>TX:</td> <td>20</td> <td>25</td> <td>27</td> <td>30</td> <td>40</td> <td>45</td> <td>50</td> <td>55</td> <td>60</td> </tr> </table>	TX:	20	25	27	30	40	45	50	55	60
TX:	20	25	27	30	40	45	50	55	60	

Item ID: **M1209TX**

NEW



9 Pieces 1/2"

1/2" RIBE SOCKET CLIP RAIL SET 100MM

- Chrome vanadium
- S2 steel bits pressed into the socket
- Satin finish for a better grip when handling the socket
- Ball recess on the female end to grip the ratchet
- Designed for use with fastenings with a multi spline Ribe type hole
- Supplied on a metal clip

Clip rail (Length: 220mm), 1/2" Drive socket clips x9										
Ribe bit sockets (Length 100mm):										
<table border="1"> <tr> <td>Ribe:</td> <td>04</td> <td>05</td> <td>06</td> <td>08</td> <td>09</td> <td>10</td> <td>11</td> <td>12</td> <td>13</td> </tr> </table>	Ribe:	04	05	06	08	09	10	11	12	13
Ribe:	04	05	06	08	09	10	11	12	13	

Item ID: **M1209**

3/4" DRIVE

MECCA PRO™



18 Pieces 3/4" mm

MECCA PRO 3/4" SOCKET SET 6 PT 18 PIECES

- Regular 6 point single hexagon sockets for a better grip
- Chrome vanadium satin finish sockets
- Supplied in the unique TengTools carrying case
- Hard wearing case with distinctive branding
- Tools clearly laid out to easily identify which tool belongs where
- Designed and manufactured to DIN and ISO standards

Quick release 72 teeth ratchet, 200mm & 400mm Extension bars																				
Sliding T-bar																				
Regular 6 point sockets:																				
<table border="1"> <tr> <td>mm:</td> <td>19</td> <td>21</td> <td>22</td> <td>24</td> <td>27</td> <td>30</td> <td>32</td> <td>33</td> <td>34</td> </tr> <tr> <td></td> <td>36</td> <td>38</td> <td>41</td> <td>46</td> <td>50</td> <td></td> <td></td> <td></td> <td></td> </tr> </table>	mm:	19	21	22	24	27	30	32	33	34		36	38	41	46	50				
mm:	19	21	22	24	27	30	32	33	34											
	36	38	41	46	50															

Item ID: **T3418-6**

MECCA PRO™



22 Pieces 3/4" mm AF

MECCA PRO 3/4" SOCKET SET MM/AF 22 PIECES

- Regular 6 point single hexagon metric sockets for a better grip
- Regular 12 point bi-hexagon AF sockets for easier alignment
- Chrome vanadium satin finish sockets
- Supplied in the unique TengTools carrying case
- Hard wearing case with distinctive branding
- Tools clearly laid out to easily identify which tool belongs where
- Designed and manufactures to DIN and ISO standards

Quick release 72 teeth ratchet, 100mm, 200mm & 400mm Extension bars										
Sliding T-bar										
Regular 6 point sockets:										
<table border="1"> <tr> <td>mm:</td> <td>19</td> <td>21</td> <td>24</td> <td>27</td> <td>32</td> <td>34</td> <td>36</td> <td>50</td> </tr> </table>	mm:	19	21	24	27	32	34	36	50	
mm:	19	21	24	27	32	34	36	50		
Regular 12 point sockets:										
<table border="1"> <tr> <td>AF:</td> <td>7/8</td> <td>1</td> <td>1-1/8</td> <td>1-3/16</td> <td>1-5/16</td> <td>1-1/2</td> <td>1-5/8</td> <td>1-3/16</td> <td>2</td> </tr> </table>	AF:	7/8	1	1-1/8	1-3/16	1-5/16	1-1/2	1-5/8	1-3/16	2
AF:	7/8	1	1-1/8	1-3/16	1-5/16	1-1/2	1-5/8	1-3/16	2	

Item ID: **T3422S**



TT SERIES x4 4 Pieces 3/4"

3/4" RATCHET & ACCESSORIES SET TTX4

- Socket accessory set
- Quick release and twist reverse action for easier use
- Sliding T bar and extension bars also included
- Designed and manufactured to DIN and ISO standards

Quick release 72 teeth ratchet, 200mm & 400mm Extension bars
Sliding T-bar

Item ID: **TTX3404**



TT SERIES x4 4 Pieces 3/4"

3/4" RATCHET & ACCESSORIES SET SAFETY LOCK

- Socket accessory set
- With safety locking system to avoid tools being dropped
- Quick release and twist reverse action for easier use
- Sliding T bar and extension bars also included
- Designed and manufactured to DIN and ISO standards

Quick release 72 teeth ratchet, 200mm & 400mm Extension bars
Sliding T-bar

Item ID: **TTX3404S**



TT SERIES x4 2 Pieces 3/4"

3/4" RATCHET & ACCESSORIES SET TTX4

- Ratchet with extendable handle 545 to 860mm
- Extension bar 16"
- Designed and manufactured according to DIN3122D

72 teeth 3/4" Drive Extendable Ratchet
16" Extension bar

Item ID: **TTX3402E**



FOAM

SERIES
x4

3 Pieces 3/4"

3/4" RATCHET & ACCESSORIES SET FOAMX4

- Quick release and twist reverse action for easier use
- Sliding T-bar and 16" (400mm) extension also included
- Tools are held in place using three colour pre-cut EVA foam clearly showing where each tool belong
- Designed and manufactured to DIN and ISO standards

Quick release 72 teeth ratchet, 400mm Extension bar

Sliding T-bar

Item ID: **TEX3403**



TT

SERIES
x4

14 Pieces 3/4" mm

3/4" SOCKET SET 6 PT TTX4 14 PIECES

- Chrome vanadium
- Satin finish for a better grip when handling the sockets
- 6 point single hexagon sockets for a better grip
- Designed and manufactured to DIN3120/3124

Regular 6 point sockets:

mm:	19	21	22	24	27	30	32	33	34
	36	38	41	46	50				

Item ID: **TTX3414**



TT

SERIES
x4

14 Pieces 3/4" AF

3/4" SOCKET SET 12 PT AF TTX4 14 PIECES

- Chrome vanadium
- Satin finish for a better grip when handling the sockets
- 12 point bi-hexagon sockets
- Designed and manufactured to DIN3120 & ASME B107.1

Regular 12 point sockets:

AF:	7/8	15/16	1	1-1/16	1-1/8	1-3/16	1-1/4	1-5/16	1-3/8
	1-7/16	1-1/2	1-5/8	1-3/4	1-7/8				

Item ID: **TTX34AF**



FOAM

SERIES
x4

10 Pieces 3/4" mm

3/4" SOCKET SET 6 PT FOAMX4 10 PIECES

- Chrome vanadium
- Satin finish for a better grip when handling the sockets
- 6 point single hexagon sockets for a better grip
- Tools are held in place using three colour pre-cut EVA foam clearly showing where each tool belongs
- Designed and manufactured to DIN3120/3124

Regular 6 point sockets:

mm:	22	24	27	30	32	36
	38	41	46	50		

Item ID: **TEX3410**

1" DRIVE



15 Pieces 1" mm

1" SOCKET SET 12 PT 15 PIECES

- Regular 12 point bi-hexagon sockets
- Chrome vanadium satin finish sockets
- Supplied in a metal carrying case
- Designed and manufactured to DIN and ISO standards

Flip reverse ratchet head with quick release, 22" handle bar

T-bar adaptor, 200mm & 400mm Extension bars

Regular 12 point sockets:

mm:	36	41	46	50	55
	60	65	70	75	80

Item ID: **M1115MM**

MIXED DRIVE

MECCA PRO™



72 Pieces 1/4" 1/2" mm

MECCA PRO 1/4" & 1/2" SOCKET SET

- 6 point 1/4" drive single hexagon sockets for a better grip
- 12 point 1/2" drive bi-hexagon sockets for easier alignment
- Chrome vanadium satin finish sockets
- An extensive range of screwdriver, hex, XZN and TX bits
- Hard wearing case with distinctive branding
- Tools clearly laid out to easily identify which tool belongs where
- Designed and manufactured to DIN and ISO standards

1/4" Drive Flip reverse ratchet, Bi-flex wrench, 4" Extension bar, Coupler adaptor

1/2" Drive Flip reverse ratchet, 5" & 10" Extension bars, Flex head adaptor, 3/8" F x 1/2" M T-bar adaptor, Universal joint

1/4" Drive Regular 6 point sockets:

mm:	4	5	5.5	6	7
	8	10	11	12	13

1/2" Drive Regular 12 point sockets:

mm:	10	11	12	13	14	15	16	17	18
	19	20	21	22	23	24	27		

Hex Keys 1.5, 2, 2.5 mm

1/4" Hex bits: TX8, TX10, TX15, TX20, TX25, TX27, TX30, TX40

1/8", 9/64", 5/32", 3/16", 7/32", 1/4", 3/8"

3, 4, 5, 6, 8, 10 PH0, PH1, PH2, PH3

PZ1, PZ2, PZ3 4, 5.5, 7 M5, M6

Item ID: **T1272**

MECCA PRO™



95 Pieces 1/4" 1/2" mm

MECCA PRO 1/4" & 1/2" SOCKET & TOOL SET

- 6 point single hexagon sockets for a better grip
- Combination spanners, screwdrivers and screwdriver bits
- Chrome vanadium satin finish sockets and spanners
- Hard wearing case with distinctive branding
- Tools clearly laid out to easily identify which tool belongs where
- Designed and manufactured to DIN and ISO standards

1/4" Drive	Flip reverse ratchet, Universal joint, 2" & 4" Extension bars, Sliding T-bar, Spinner handle, Coupler adaptor, 50mm Magnetic bit holder
1/2" Drive	Flip reverse ratchet, 5" & 10" Extension bars, 5/16" Hex coupler, 3/8" F x 1/2" M T-bar adaptor, Universal joint
1/4" Drive 6 point sockets:	
Reg mm:	4 4.5 5 5.5 6 7
	8 9 10 11 12 13
Deep mm:	4 5 6 7 8 9
	10 11 12 13
1/2" Drive 6 point sockets:	
Reg mm:	10 11 12 13 14 15 17
	19 22 24 27 30 32
Spark plug sockets mm:	21
Screwdrivers:	3 4 PH1 PH2 PZ1 PZ2
Combination Spanners:	8, 10, 12, 13, 14, 17 mm
1/4" Hex bits:	TX8, TX10, TX15, TX20, TX25, TX27, TX30, TX40
	3, 4, 5, 6, 8, 10 PH0, PH1, PH2, PH3, PH4
	PZ0, PZ1, PZ2, PZ3 4, 5.5, 7
5/16" Hex bits:	TX45, TX50, TX55

Item ID: TM095

MECCA PRO™



106 Pieces 1/4" 3/8" 1/2" mm

MECCA PRO 1/4", 3/8" & 1/2" SOCKET SET

- 6 point 1/4" & 3/8" drive sockets for a better grip
- 12 point 1/2" drive bi-hexagon sockets for easier alignment
- Combination spanners, double flex wrenches and adjustable wrench
- Chrome vanadium satin finish sockets and spanners
- Hard wearing case with distinctive branding
- Tools clearly laid out to easily identify which tool belongs where
- Designed and manufactured to DIN and ISO standards

1/4" Drive	Flip reverse ratchet, Universal joint, 2" & 3" Extension bars, Bi-flex wrench, Coupler adaptor, Bits driver, Magnetic bit holder
3/8" Drive	Flip reverse ratchet, 3" & 6" Extension bars, Coupler adaptor, 3/8" F x 1/4" M, 3/8" F x 1/2" M T-bar adaptors, Universal joint
1/2" Drive	2 1/2" & 10" Extension bars, 1/2" F x 3/8" M T-bar adaptor, Flex head adaptor
1/4" Drive 6 point sockets:	
Reg mm:	4 5 6 7 8 10 12 13
Deep mm:	6 7 8 10 12 13
3/8" Drive 6 point sockets:	
Reg mm:	8 9 10 12 13 14 15
	16 17 18 19 21 22
Spark plug sockets mm:	16 21
1/2" Drive 12 point sockets:	
Reg mm:	19 24 27 30 32
Double flex wrenches:	8x9, 10x11, 12x13, 14x15 mm
Combination Spanners:	8, 9, 10, 11, 12, 13, 14, 15, 16, 17, 18, 19 mm
Adjustable wrench:	10"
1/4" Hex bits:	TX8, TX10, TX15, TX20, TX25, TX27, TX30, TX40
	TPX10, TPX15, TPX20, TPX25, TPX27, TPX30, TPX40
	3, 4, 5, 6, 8, 10 PH0, PH1, PH2, PH3
	PZ1, PZ2, PZ3 4, 5.5, 7 M5, M6

Item ID: TM106

MECCA PRO™



111 Pieces 1/4" 3/8" 1/2" mm AF

MECCA PRO 1/4", 3/8" & 1/2" SOCKET SET MM/AF

- Chrome vanadium satin finish sockets and spanners
- Supplied in the unique TengTools carrying case
- Hard wearing case with distinctive branding
- Easy to identify which tool belongs where
- Designed and manufactured to DIN and ISO standards

1/4" Drive	Flip reverse ratchet, 5/16" Hex coupler, 6" Flexible extension, 2" & 4" Extension bars, Spinner handle, Universal joint, 1/4" F x 3/8" M adaptor, 4" T-bar
3/8" Drive	Flip reverse ratchet, 1/4" Hex bit holder, 3" & 6" Extension bars, Spinner handle, Universal joint, 3/8" F x 1/2" M adaptor, Spin disc
1/2" Drive	Flip reverse ratchet, 5/16" Hex coupler, 2 1/2" & 10" Extension bars, 1/2" F x 3/8" M adaptor, Spin disc
1/4" Drive 6 point sockets:	
Reg mm:	4 5 6 7 8 10 12
Reg AF:	3/16 7/32 1/4 9/32 3/8 7/16
3/8" Drive 6 point sockets:	
Reg mm:	8 9 10 12 13 14 15 16 17
Deep mm:	8 9 10 12 13 14 15 16 17
Reg AF:	3/8 7/16 1/2 9/16 11/16 3/4 13/16 7/8
Deep AF:	3/8 7/16 1/2 9/16 11/16 3/4 13/16 7/8
Spark plug sockets mm:	16 21
1/2" Drive 6 point sockets:	
Reg mm:	17 24 27 32
Reg AF:	11/16 3/4 13/16 7/8 1 1-3/16
1/4" Hex bits:	TX10, TX15, TX20, TX25, TX30, TX40 4, 5.5, 7
	3, 4, 5, 6, 7, 10 1/8", 9/64", 5/32", 3/16", 1/4", 5/16"
	PZ1, PZ2, PZ3 PH1, PH2, PH3
5/16" Hex bits:	TX45, TX50

Item ID: TM111

MECCA PRO™



127 Pieces 1/4" 3/8" 1/2" mm AF

MECCA PRO 1/4", 3/8" & 1/2" SOCKET & TOOL SET

- Chrome vanadium satin finish sockets and spanners
- A range of combination spanners and adjustable wrench
- Hard wearing case with distinctive branding
- Easy to identify which tool belongs where
- Designed and manufactured to DIN and ISO standards

1/4" Drive	Flip reverse ratchet, Universal joint, 2" & 3" Extension bars, Coupler adaptor
3/8" Drive	Flip reverse ratchet, 3" & 6" Extension bars, Universal joint, Coupler adaptor, 3/8" F x 1/4" M adaptor, 3/8" F x 1/2" M adaptor
1/2" Drive	2 1/2" & 10" Extension bars, Flex head adaptor, 1/2" F x 3/8" M adaptor
1/4" Drive 6 point sockets:	
Reg mm:	4 5 5.5 6 7
	8 10 11 12 13
Deep mm:	6 7 8 10 12 13
Reg AF:	3/16 7/32 1/4 9/32 5/16 11/32 3/8 7/16 1/2
3/8" Drive 6 point sockets:	
Reg mm:	8 9 10 11 12 13 14
	15 16 17 18 19 21 22
Reg AF:	5/16 3/8 7/16 1/2 9/16
	5/8 11/16 3/4 13/16 7/8
Spark plug sockets mm:	16 21
1/2" Drive 12 point sockets:	
Reg mm:	19 24 27 30 32
Ratcheting bits driver, Spanner ring, 10" Adjustable wrench	
Combination Spanners: 8, 9, 10, 11, 12, 13, 14, 15, 16, 17, 18, 19 mm	
1/4" Hex bits:	TX8, TX10, TX15, TX20, TX25, TX27, TX30, TX40
	3, 4, 5, 6, 8, 10 1/8", 9/64", 5/32", 3/16", 1/4", 3/8"
	PZ1 (x2), PZ2 (x2), PZ3 PH0, PH1 (x2), PH3
	4, 5.5, 7 (x2) M5, M6

Item ID: TM127

IMPACT



6 Pieces 1/2" mm

1/2" XZN IMPACT SOCKET SET DIN 6 PIECES

- Chrome molybdenum with a manganese phosphate finish for added corrosion resistance
- Suitable for use with power tools
- DIN standard design for use with a retaining pin and ring
- Supplied in the unique TengTools case with a snap lock
- Hard wearing hinge with a metal pin for longer life

1/2" Drive Impact XZN bits sockets:

Length 43mm:	14	16	18
Length 78mm:	14	16	18

Item ID: T9206



DIN Standard sockets require a retaining ring and pin to safely secure the socket to the impact tool.

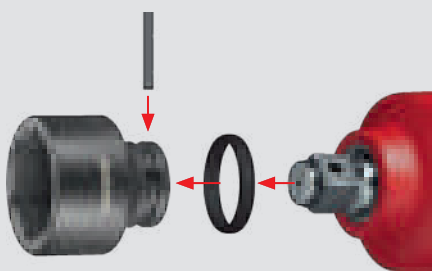

MECCA PRO™

NEW



22 Pieces 1/2" mm

1/2" DR IMPACT METRIC STANDARD SOCKET SET

- 18 regular metric sockets from 10 to 32 mm
- Retaining pins (2 pcs) and rings (2 pcs) included
- Made of chrome molybdenum (CR-MO)
- For use with power tools
- Supplied in a robust blow moulded box
- Designed and manufactured to DIN3129

Retaining rings & pins: O92194, O92244, P92320, P92325 x1

1/2" Drive Impact 6 point sockets:

Reg mm:	10	11	12	13	14	15	16	17	18
	19	21	22	24	27	28	29	30	32

Item ID: T9222

MECCA PRO™

NEW



22 Pieces 1/2" mm

1/2" DR IMPACT METRIC DEEP SOCKET SET

- 18 deep metric sockets from 10 to 32 mm
- Retaining pins (2 pcs) and rings (2 pcs) included
- Made of chrome molybdenum (CR-MO)
- For use with power tools
- Supplied in a robust blow moulded box
- Designed and manufactured to DIN3129

Retaining rings & pins: O92194, O92244, P92320, P92325 x1

1/2" Drive Impact 6 point sockets:

Deep mm:	10	11	12	13	14	15	16	17	18
	19	21	22	24	27	28	29	30	32

Item ID: T9222L

MECCA PRO™

NEW



40 Pieces 1/2" mm

1/2" DR IMPACT METRIC STD/DEEP SOCKET SET

- Regular & deep metric sockets from 10 to 32 mm
- Retaining pins (2 pcs) and rings (2 pcs) included
- Made of chrome molybdenum (CR-MO)
- For use with power tools
- Supplied in a robust blow moulded box
- Designed and manufactured to DIN3129

Retaining rings & pins: O92194, O92244, P92320, P92325 x1

1/2" Drive Impact 6 point sockets:

Reg mm:	10	11	12	13	14	15	16	17	18
	19	21	22	24	27	28	29	30	32
Deep mm:	10	11	12	13	14	15	16	17	18
	19	21	22	24	27	28	29	30	32

Item ID: T9240

MECCA PRO™

NEW



18 Pieces 1/2" AF

1/2" DR IMPACT AF STANDARD SOCKET SET

- 14 regular imperial sockets from 3/8" to 1-1/4"
- Retaining pins (2 pcs) and rings (2 pcs) included
- Made of chrome molybdenum (CR-MO)
- For use with power tools
- Supplied in a robust blow moulded box

Retaining rings & pins: O92194, O92244, P92320, P92325 x1

1/2" Drive Impact 6 point sockets:

Reg AF:	3/8	7/16	1/2	9/16	5/8	11/16	3/4
	13/16	7/8	15/16	1	1-1/16	1-1/8	1-1/4

Item ID: T9218AF

MECCA PRO™

NEW



18 Pieces 1/2" AF

1/2" DR IMPACT AF DEEP SOCKET SET

- 14 deep imperial sockets from 3/8" to 1-1/4"
- Retaining pins (2 pcs) and rings (2 pcs) included
- Made of chrome molybdenum (CR-MO)
- For use with power tools
- Supplied in a robust blow moulded box

Retaining rings & pins: O92194, O92244, P92320, P92325 x1

1/2" Drive Impact 6 point sockets:

Deep AF:	3/8	7/16	1/2	9/16	5/8	11/16	3/4
	13/16	7/8	15/16	1	1-1/16	1-1/8	1-1/4

Item ID: T9218LAF

MECCA PRO™

NEW



17 Pieces 3/4" mm

3/4" DR IMPACT METRIC STANDARD SOCKET SET

- 15 regular metric sockets from 19 to 50 mm
- Retaining pin and ring included
- Made of chrome molybdenum (CR-MO)
- For use with power tools
- Supplied in a robust blow moulded box
- Designed and manufactured to DIN3129

Retaining rings & pins: O95036, P90435 x1

1/2" Drive Impact 6 point sockets:

Reg mm:	19	21	22	23	24	27	30	32
	33	34	36	38	41	46	50	

Item ID: T9417

MECCA PRO™

NEW



17 Pieces 3/4" mm

3/4" DR IMPACT METRIC DEEP SOCKET SET

- 15 deep metric sockets from 19 to 50 mm
- Retaining pin and ring included
- Made of chrome molybdenum (CR-MO)
- For use with power tools
- Supplied in a robust blow moulded box
- Designed and manufactured to DIN3129

Retaining rings & pins: O95036, P90435 x1

1/2" Drive Impact 6 point sockets:

Deep mm:	19	21	22	23	24	27	30	32
	33	34	36	38	41	46	50	

Item ID: T9417L

MECCA PRO™

NEW



23 Pieces 3/4" AF

3/4" DR IMPACT AF STANDARD SOCKET SET

- 21 regular imperial sockets from 11/16" to 2"
- Retaining pin and ring included
- Made of chrome molybdenum (CR-MO)
- For use with power tools
- Supplied in a robust blow moulded box

Retaining rings & pins: O95036, P90435 x1

1/2" Drive Impact 6 point sockets:

Reg AF:	11/16	3/4	13/16	7/8	15/16	1	1-1/16
	1-1/8	1-3/16	1-1/4	1-5/16	1-3/8	1-7/16	1-1/2
	1-9/16	1-5/8	1-11/16	1-3/4	1-7/8	1-15/16	2

Item ID: T9423AF

MECCA PRO™

NEW



21 Pieces 3/4" AF

3/4" DR IMPACT AF DEEP SOCKET SET

- 19 deep imperial sockets from 3/4" to 1-7/8"
- Retaining pin and ring included
- Made of chrome molybdenum (CR-MO)
- For use with power tools
- Supplied in a robust blow moulded box

Retaining rings & pins: O95036, P90435 x1

1/2" Drive Impact 6 point sockets:

Deep AF:	3/4	13/16	7/8	15/16	1	1-1/16	1-1/8
	1-3/16	1-1/4	1-5/16	1-3/8	1-7/16	1-1/2	1-9/16
	1-5/8	1-11/16	1-3/4	1-13/16	1-7/8		

Item ID: T9421LAF

TT SERIES



24 Pieces 1/4" 3/8" mm

1/4" & 3/8" IMPACT SOCKET SET ANSI TTI

- Chrome molybdenum for use with power tools
- ANSI standard design for use with power tools with a ball bearing socket retainer

3/8" F x 1/4" M impact adaptor

1/4" Drive Impact 6 point sockets:

Reg mm:	6	7	8	10	13
---------	---	---	---	----	----

3/8" Drive Impact 6 point sockets:

Reg mm:	8	10	11	12	13	14	16	17	19
Deep mm:	8	10	11	12	13	14	16	17	19

Item ID: TT9024



TT SERIES

11 Pieces 1/2"

1/2" IMPACT SOCKET ACCESSORIES SET DIN TTI

- A selection of extension bars and adaptors
- DIN standard design for use with a retaining pin and ring
- Chrome molybdenum for use with power tools

Impact Adaptors: 3/8" F x 1/2" M, 1/2" F x 3/8" M, 1/2" F x 3/4" M

Universal Joint, 3", 5" & 10" Extension bars

Retaining rings & pins: O92194, O92244, P92320, P92325 x1

Item ID: TT9207



TT SERIES

11 Pieces 1/2"

1/2" IMPACT SOCKET ACCESSORIES SET ANSI TTI

- A selection of extension bars and adaptors
- For use with ANSI sockets
- Chrome molybdenum for use with power tools

Impact Adaptors: 3/8" F x 1/2" M, 1/2" F x 3/8" M, 1/2" F x 3/4" M

Universal Joint, 3", 5" & 10" Extension bars

Retaining rings & pins: O92194, O92244, P92320, P92325 x1

Item ID: TT9207A



TT SERIES

16 Pieces 1/2" mm

1/2" IMPACT SOCKET SET ANSI TTI 16 PIECES

- ANSI standard design for use with power tools with a ball bearing socket retainer
- Chrome molybdenum for use with power tools

1/2" Drive Impact 6 point sockets:

Reg mm:	13	15	16	17	18	19	22	24
Deep mm:	13	15	16	17	18	19	22	24

Item ID: TT9116N



TT SERIES

12 Pieces 1/2" mm

1/2" IMPACT SOCKET SET DIN TTI 12 PIECES

- DIN standard design for use with a retaining pin and ring
- Chrome molybdenum for use with power tools
- O-rings & pins included
- Designed and manufactured to DIN3129

Retaining rings & pins: O92244, P92325 x1

1/2" Drive Impact 6 point sockets:

Reg mm:	19	21	22	24	27	30	32
Deep mm:	19	21	22	24	27		

Item ID: TT9212



TT SERIES
1

20 Pieces 1/2" mm

1/2" IMPACT SOCKET SET DIN TT1 20 PIECES

- DIN standard design for use with a retaining pin and ring
- Chrome molybdenum for use with power tools
- Designed and manufactured to DIN3129

Retaining rings & pins: O92194, O92244, P92320, P92325 x1

1/2" Drive Impact 6 point sockets:

Reg mm:	13	15	16	17	18	19	22	24
Deep mm:	13	15	16	17	18	19	22	24

Item ID: TT9120DN



TT SERIES
1

8 Pieces 1/2"

1/2" TORQUE STICKS & WHEEL NUT SET TT1

- For the correct tightening of wheel nut sockets on cars
- When the correct torque is reached the torque stick socket end stops turning while the drive end springs back with each stroke
- Reduces the risk of sheared wheel nut bolts or distorted rims and brake discs
- Chrome molybdenum wheel nut sockets with protective inserts to avoid damage to wheels

3/8" x 1/2" Torque step up adaptor

1/2" Drive Torque sticks:

Nm:	90	110	120	140
-----	----	-----	-----	-----

1/2" Drive wheel nut sockets:

mm:	17	19	21
-----	----	----	----

Item ID: TTTS08



TT SERIES
1

12 Pieces 1/2"

1/2" TX IMPACT SOCKET SET DIN TT1

- Chrome molybdenum for use with power tools
- DIN standard design for use with a retaining pin and ring

1/2" Drive Impact TX bit sockets:

TX:	10	15	20	25	27	30	40	45
	50	55	60	70				

Item ID: TT9212TX



TT SERIES
1

15 Pieces 3/8" 1/2" mm

3/8" & 1/2" HEX IMPACT SOCKET SET DIN TT1

- Chrome molybdenum for use with power tools
- DIN standard design for use with a retaining pin and ring
- Designed and manufactured to DIN3129

3/8" Drive Impact Hex bit sockets:

mm:	4	5	6	7	8	10	12
-----	---	---	---	---	---	----	----

1/2" Drive Impact Hex bit sockets:

mm:	5	6	8	10	12	14	17	19
-----	---	---	---	----	----	----	----	----

Item ID: TT9015HX



TT SERIES
2

16 Pieces 3/4" mm

3/4" IMPACT SOCKET SET DIN TT2 16 PIECES

- 7" impact extension bar included for reaching in to recessed wheels, etc
- DIN standard design for use with a retaining pin and ring (included)
- Chrome molybdenum for use with power tools
- Supplied in the unique TengTools TT tray

7" Extension bar

Retaining rings & pins: O95036 x3, P90435 x3

3/4" Drive Impact 6 point sockets:

Reg mm:	19 (3/4")	24	27 (1-1/16")	30 (1-3/16")	32	33
		34	36	38		

Item ID: TTD9416



TT SERIES
x4

15 Pieces 3/4" mm

3/4" IMPACT SOCKET SET DIN TTX4 15 PIECES

- DIN standard design for use with a retaining pin and ring
- Chrome molybdenum for use with power tools
- Supplied in the unique TengTools drawer width TTX4 tray

3/4" Drive Impact 6 point sockets:

Reg mm:	19 (3/4")	24	27 (1-1/16")	28
		30 (1-3/16")	32	34
Deep mm:	19 (3/4")	24	27 (1-1/16")	
		30 (1-3/16")	32	33

Item ID: TTX9415

NEW



FOAM SERIES
1

16 Pieces 1/2" AF

1/2" IMPACT SOCKET SET DIN AF FOAM2

- DIN standard design for use with a retaining pin and ring.
- Chrome molybdenum for use with power tools.
- Black phosphate finish for easy identification as an impact socket.
- Ring and pin fixing hole on the female end to secure the socket.
- Retaining ring and pin included in the set.
- Tools are held in place using three colour pre-cut EVA foam clearly showing where each tool belongs
- Designed and manufactured to ASME B107.110

Retaining rings & pins: O92194, O92244, P92320, P92325 x1

1/2" Drive Impact 6 point sockets:

Reg AF:	3/8"	7/16"	1/2"	9/16"	5/8"	3/4"	13/16"	7/8"	1"
		1-1/16"	1-1/8"	1-1/4"					

Item ID: TEA9216AF

NEW



FOAM SERIES
1

14 Pieces 1/2" AF

1/2" IMPACT SOCKET SET DEEP DIN AF FOAM2

- DIN standard design for use with a retaining pin and ring
- Chrome molybdenum for use with power tools
- Black phosphate finish for easy identification as an impact socket
- Ring and pin fixing hole on the female end to secure the socket
- Retaining ring and pin included in the set
- Tools are held in place using three colour pre-cut EVA foam clearly showing where each tool belongs
- Designed and manufactured to ASME B107110

Retaining rings & pins: O92194, O92244, P92320, P92325 x1

1/2" Drive Impact 6 point sockets:

Deep AF:	7/16"	1/2"	9/16"	5/8"	11/16"
		3/4"	13/16"	7/8"	15/16"

Item ID: TEA9214LAF



FOAM SERIES

2

21 Pieces 1/2" mm

1/2" IMPACT SOCKET SET ANSI FOAM2

- ANSI standard design for use with power tools with a ball bearing socket retainer
- Selection of extension bars and adaptors
- Supplied in the unique TengTools FOAM2 tray
- Tools are held in place using three colour pre-cut EVA foam clearly showing where each tool belongs

3" & 10" Extension bars, Universal joint, 3/8"F x 1/2"M & 1/2"F x 3/4"M Impact adaptors

1/2" Drive Impact 6 point sockets:

Reg mm: 13 15 16 17 18 19 22 24

Deep mm: 13 15 16 17 18 19 22 24

Item ID: TED9121



8 Pieces 3/8" mm

3/8" IMPACT SOCKET CLIP RAIL SET ANSI

- ANSI standard design for use with power tools with a ball bearing socket retainer
- Chrome molybdenum for use with power tools
- Supplied on a 290mm clip rail for storage as a set

Clip rail (Length: 290mm), 3/8" Drive socket clips x8

Impact 6 point sockets:

Reg mm: 8 10 11 13 14 16 17 19

Item ID: 9381



8 Pieces 3/8" mm

3/8" DEEP IMPACT SOCKET CLIP RAIL SET ANSI

- ANSI standard design for use with power tools with a ball bearing socket retainer
- Chrome molybdenum for use with power tools
- Supplied on a 290mm clip rail for storage as a set

Clip rail (Length: 290mm), 3/8" Drive socket clips x8

Impact 6 point sockets:

Deep mm: 8 10 11 13 14 16 17 19

Item ID: 9386



10 Pieces 1/2" mm

1/2" IMPACT SOCKET CLIP RAIL SET ANSI

- ANSI standard design for use with power tools with a ball bearing socket retainer
- Chrome molybdenum for use with power tools
- Supplied on a clip rail for storage as a set

Clip rail (Length: 290mm), 1/2" Drive socket clips x10

Impact 6 point sockets:

Reg mm: 10 11 12 13 14

17 19 21 22 24

Item ID: 9121



10 Pieces 1/2" mm

1/2" DEEP IMPACT SOCKET CLIP RAIL SET ANSI

- ANSI standard design for use with power tools with a ball bearing socket retainer
- Chrome molybdenum for use with power tools
- Supplied on a clip rail for storage as a set

Clip rail (Length: 290mm), 1/2" Drive socket clips x10

Impact 6 point sockets:

Deep mm: 10 11 12 13 14

17 19 21 22 24

Item ID: 9126



12 Pieces 1/2" mm

1/2" STUBBY IMPACT SOCKET CLIP RAIL SET DIN

- Short reach for use in confined spaces
- DIN standard design for use with a retaining pin and ring
- Chrome molybdenum for use with power tools
- Black phosphate finish for easy identification as an impact socket accessory
- Ring and pin fixing hole on the female end to secure the socket to the air gun
- Designed and manufactured to DIN3129

Clip rail (Length: 290mm), 1/2" Drive socket clips x10

Impact 6 point sockets:

Deep mm: 10 11 12 13 14 15

16 17 19 21 22 24

Item ID: 9207S12

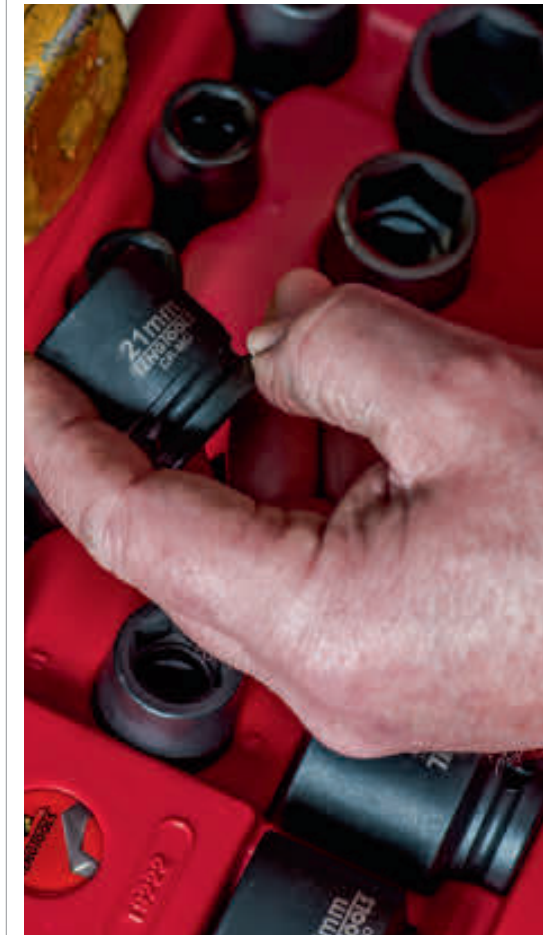

SOCKETS & ACCESSORIES

GET THE JOB DONE, FAST

The socket range includes drives from ¼" to 1" and includes six-point sockets and twelve-point sockets, metric and imperial sizes as well as a wide range of bit sockets including Hex, TX, TX-E, and TPX.



72 TEETH RATCHETS

72 teeth ratchets give a working arc of just 5 degrees, resulting in outstanding accessibility in confined areas

The ratchet head is sealed, which prevents dirt and dust from entering the mechanism – giving a longer life and trouble-free use

More teeth are engaged simultaneously – which means you can use greater force without the mechanism failing

The rotation disc, to change direction, has a good grip for oily fingers or gloves

Ergonomic bi-material grip for maximum comfort while using



FRP RATCHETS

Quick release mechanism that makes it possible to release sockets and accessories with one hand

Ratchet mechanism with 45 teeth (8 degree intervals)

Lever for quick reversing between left and right-hand action

All individual parts and service kits are available and easy to fit

Fibre ratchet handle with steel reinforcement that is lighter than standard ratchet handles, but just as strong

Bi-material handle with an ergonomic design that makes the ratchet very comfortable to use, especially in cold environments





1/4"

1/4" MINI BITS RATCHET

- 1/4" hex drive reversible bits ratchet
- Overall length 90mm making it very compact and easy to keep in the pocket
- Flip reverse mechanism for quickly changing between tightening and loosening
- Chrome vanadium satin finish drop forged steel
- For use with 1/4" drive hex bits
- 8mm double hexagon ring spanner on the other end

Item ID: **1400B**



1/4"

1/4" RATCHET HEAD HEX

- Fine tooth mini ratchet head
- Designed for use together with any 1/4" hex drive bit holder
- 1/4" square drive for use with sockets and accessories
- 1/4" hexagon drive for use with screwdriver bits and accessories
- 72 teeth for use in confined spaces
- Flip reverse for quickly and easily changing between tightening and loosening
- Designed and manufactured to DIN3122D

Item ID: **RHA14**



1/4"

1/4" GEARLESS RATCHET

- Gearless palm ratchet
- 1/4" square drive for use with sockets and accessories
- 1/4" hexagon drive for use with screwdriver bits and accessories
- Handle designed for easy rotation with the fingers
- Use with an extension bar to create a ratcheting T bar
- Gearless mechanism for use in confined spaces
- Twist reverse for quickly and easily changing between tightening and loosening

Item ID: **PM14**



1/4"

1/4" MINI PALM RATCHET

- Handle designed for use in the palm of the hand
- Use with an extension bar to create a ratcheting T bar
- For use in confined spaces
- Twist reverse for quickly and easily changing between tightening and loosening
- Slim design together with a bi-material grip for extra comfort

Item ID: **1400M**



1/4"

1/4" MINI RATCHET 72 TEETH

- Fine tooth mini ratchet
- Shorter handle for easier use in confined spaces
- 72 teeth giving 5 degree increments between clicks
- Twist reverse for quickly and easily changing between tightening and loosening
- Slim design together with a bi-material grip for extra comfort
- Designed and manufactured to DIN3122D

Item ID: **1400-72MN**



RATCHET 72 TEETH

- Fine tooth ratchet
- 72 teeth giving 5 degree increments between clicks
- Twist reverse for quickly and easily changing between tightening and loosening
- Slim design together with a bi-material grip for extra comfort
- Designed and manufactured to DIN3122D

ITEM ID:	Drive	Reverse	Quick Release	No. of Teeth	Length mm	Weight g
1400-72N	1/4"	Twist		72	150	110
3800-72N	3/8"	Twist	Y	72	203	265
1200-72N	1/2"	Twist	Y	72	250	400



RATCHET 72 TEETH FLEXIBLE HEAD

- Fine tooth stubby flex head ratchet
- Shorter handle for easier use in confined spaces
- Flexible ratchet head with locking mechanism for use at different angles
- 72 teeth giving 5 degree increments between clicks
- Twist reverse for quickly and easily changing between tightening and loosening
- Slim design together with a bi-material grip for extra comfort

ITEM ID:	Drive	Reverse	Quick Release	No. of Teeth	Length mm	Weight g
1400-72SN	1/4"	Twist		72	121	114
3800-72SN	3/8"	Twist	Y	72	178	270
1200-72SN	1/2"	Twist	Y	72	190	395



RATCHET FRP 45 TEETH

- Fibre reinforced handle with three metal plates for added strength
- 45 teeth giving 8 degree increments between clicks
- Flip reverse for quickly and easily changing between tightening and loosening
- Quick release for easier changing between different sockets and accessories
- Bi-material grip for extra comfort
- Designed and manufactured to DIN3122D

ITEM ID:	Drive	Reverse	Quick Release	No. of Teeth	Length mm	Weight g
1400FRP	1/4"	Flip	Y	45	150	96
3800FRP	3/8"	Flip	Y	45	203	227
1200FRP	1/2"	Flip	Y	45	255	358



1/2"

1/2" LONG RATCHET FLEXIBLE HEAD

- 400mm long handle for added torque when needed
- Flexible ratchet head with locking mechanism for use at different angles
- 45 teeth giving 8 degree increments between clicks
- Twist reverse for quickly and easily changing between tightening and loosening
- Quick release for easier changing between different sockets and accessories
- Bi-material grip for extra comfort

Item ID: **1200F**



1/2"

1/2" RATCHET LONG ARM

- 400mm long handle for added torque when needed
- 45 teeth giving 8 degree increments between clicks
- Twist reverse for quickly and easily changing between tightening and loosening
- Quick release for easier changing between different sockets and accessories
- Bi-material grip for extra comfort

Item ID: **1200L**



RATCHET HEAVY DUTY

- Twist reverse for quickly and easily changing between tightening and loosening
- Quick release for easier changing between different sockets and accessories
- Rubber grip on the handle for a better grip particularly in wet or oily conditions
- Ball bearing socket retainer on the square drive to securely grip the socket

ITEM ID:	Drive	Reverse	Quick Release	No. of Teeth	Length mm	Weight g
M3400-72	3/4"	Twist	Y	72	505	2000
M1100-72	1"	Twist	Y	72	800	4060



3/4"

3/4" EXTENDABLE RATCHET

- Quick release button allowing the user to change quickly between sockets
- Twist reverse for changing between left and right direction
- Length is 545mm and extends to 860mm

ITEM ID:	Drive	Reverse	Quick Release	No. of Teeth	Length mm	Weight g
M340072E	3/4"	Twist	Y	72	545/860	3382



1"

1" RATCHET

- Detachable head to enable the bar to be used as a power bar
- 24 teeth giving 15 degree increments between clicks
- Flip reverse for quickly and easily changing between tightening and loosening
- Quick release for easier changing of sockets
- Ball bearing socket retainer on the square drive
- Knurled grip area on the handle for a better grip particularly in wet or oily conditions
- Designed and manufactured to DIN3122D

ITEM ID:	Drive	Reverse	Quick Release	No. of Teeth	Length mm	Weight g
M1100	1"	Flip	Y	24	665	4410



1"

1" RATCHET HEAD

- For use with the 1" power bar (M110020)
- 24 teeth giving 15 degree increments between clicks
- Flip reverse for quickly and easily changing between tightening and loosening
- Quick release for easier changing between different sockets and accessories
- Ball bearing socket retainer on the square drive to securely grip the socket
- Designed and manufactured to DIN3122D

ITEM ID:	Drive	Reverse	Quick Release	No. of Teeth	Length mm	Weight g
M110010	1"	Flip	Y	24	165	1740



1"

1" POWER BAR

- For use as a ratchet handle together with the M110010 ratchet head
- Can be used to create a power bar or T bar together with the M110030 T bar adaptor
- Chrome vanadium
- Satin finish for a better grip when handling sockets
- Ball bearing socket retainer on the square drive to securely grip the socket
- Knurled grip area on the handle for a better grip particularly in wet or oily conditions

Item ID: **M110020**

RATCHET SERVICE KITS

- Full service kit for ratchets
- Includes a set of replacement parts for the ratchet mechanism
- Simple and quick to fit so the ratchet does not need to be sent away
- Reduces the amount of time that the ratchet is out of use

ITEM ID:	Drive	Service Kit For:
1400-72NRK	1/4"	1400-72N & 1400-72SN
1400FRPRK	1/4"	1400FRP
3800-72NRK	3/8"	3800-72N & 3800-72SN
3800FRPRK	3/8"	3800FRP
1200-72NRK	1/2"	1200-72N & 1200-72SN
1200FRPRK	1/2"	1200FRP
1201RK	1/2"	1201
1201ARK	1/2"	1201A
1200FRK	1/2"	1200F & 1200L
M3400-72RK	3/4"	M3400-72
M1100-72RK	1"	M1100-72
M1100RK	1"	M1100 & M110010



1/4"

FLEXIBLE SOCKET DRIVER

- Flexible spring wound shaft for easier access in confined spaces
- Overall length 275mm
- For use with 1/4" drive sockets and accessories
- Ergonomically designed bi-material handle for easy use with higher torque and faster speed
- Hole in the handle for hanging or for use as a T handle for extra torque or with a fall protection wire if needed

Item ID: **MD514N**



SPINNER HANDLE

- Ergonomically designed bi-material handle for easy use particularly in wet or oily conditions
- Chrome vanadium
- Satin finish for a better grip when handling sockets
- Ball bearing recess on the female end to grip the ratchet or power bar
- Ball bearing socket retainer on the male end to securely grip the socket
- Designed and manufactured to DIN3122E
- Supplied with a metal socket clip for use with a socket rail

ITEM ID:	Drive	Overall Length mm	List Price
M140015-C	1/4"	150	
M380015-C	3/8"	250	



1/4"

EXTRA LONG FLEXIBLE SOCKET DRIVER

- Long reach flexible socket driver
- Flexible spring wound shaft for easier access in confined spaces
- Protected by a plastic sleeve to avoid pinching
- Overall length 555mm
- For use with 1/4" drive sockets and accessories
- Ergonomically designed bi-material handle for easy use with higher torque and faster speed
- Hole in the handle for hanging or for use as a T handle for extra torque or with a fall protection wire if needed

Item ID: **MD514L**



3/8"

ROTATING SPINNER HANDLE

- 10" (250mm) spinner handle and extension bar
- Rotating handle end creates an easy to use grip especially when using together with a ratchet
- Ergonomically designed bi-material handle for easy use particularly in wet or oily conditions
- 3/8" drive female intake in the handle to enable use as an extension bar
- Chrome vanadium
- Satin finish for a better grip when handling sockets
- Ball bearing recess on the female end to grip the ratchet or power bar
- Ball bearing socket retainer on the male end to securely grip the socket
- Designed and manufactured to DIN3122E
- Supplied with a metal socket clip for use with a socket rail

Item ID: **PT3810R**



Spinner handle with female intake in the handle can be used with a 3/8" drive ratchet as an extension bar

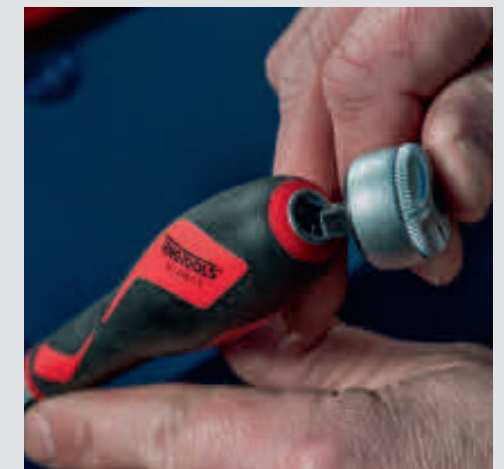



FLEX HANDLE OFFSET

- Designed for extra torque to use with stubborn nuts and bolts
- Ball bearing socket retainer on the square drive for secure grip
- Chrome vanadium
- Satin finish for a better grip when handling sockets
- Ergonomically designed bi-material handle for easy use particularly in wet or oily conditions
- Designed and manufactured to DIN3122F

ITEM ID:	Drive	Length		Weight g	
		AF	mm		
M380010A-C	3/8"	10"	250	Offset Shaft	375
M120010-C	1/2"	10"	265		492
1201	1/2"	17"	450		894
1201A	1/2"	24"	600		1198
M340070-C	3/4"	19"	480		1880
M340070S-C	3/4"	19"	480	Safety Locking	1880
M110070	1"	25"	650		3550

FLEX HANDLE SERVICE KITS

- Includes a set of replacement parts for the square drive
- Simple to fit so the flex handle does not need to be sent away
- Reduces the time that the flex handle is out of use

ITEM ID:	Drive	Service Kit For:
1201RK	1/2"	1201
1201ARK	1/2"	1201A
M120010RK	1/2"	M120010RK
M340070RK	3/4"	M340070-C
M340070SRK	3/4"	M340070S-C
M110070RK	1"	M110070



SPEED BRACE

- Designed to transport fastenings more quickly
- Ball bearing socket retainer on the square drive for secure grip
- Chrome vanadium
- Satin finish for a better grip when handling sockets
- Knurled grip area on the handle for a better grip particularly in wet or oily conditions

ITEM ID:	Drive	Length mm	Weight g
M380011-C	3/8"	380	310
M120011-C	1/2"	420	585



WOBBLE EXTENSION BARS

- Made from chrome vanadium steel
- Ball point end allows the socket to be turned even at an angle
- Ideal for use in confined spaces
- Satin finish for a better grip when handling sockets
- Ball bearing recess on the female end to grip the ratchet
- Ball bearing socket retainer on the male end to securely grip the socket
- Supplied with a metal socket clip for use with a socket rail

ITEM ID:	Drive	Length		Safety Locking Screw	Weight g
		AF	mm		
M380020W-C	3/8"	3"	75	Y	63
M380021W-C	3/8"	6"	150	N	145
M380022W-C	3/8"	10"	255	N	234
M120020W-C	1/2"	3"	75	Y	105
M120021W-C	1/2"	6"	150	N	240
M120022W-C	1/2"	10"	255	N	420



EXTENSION BARS

- Made from chrome vanadium steel
- Ball bearing recess on the female end to grip the ratchet
- Ball bearing socket retainer on the male end to securely grip the socket
- Designed and manufactured to DIN3123B
- Supplied with a metal socket clip for use with a socket rail

ITEM ID:	Drive	Length AF	Length mm	Safety Lock	Weight g
M140020-C	1/4"	2"	50	N	22
M140023-C	1/4"	3"	75	N	35
M140021-C	1/4"	4"	100	N	46
M140022-C	1/4"	6"	150	N	65
M140038-C	1/4"	6"	150	N	26
M140024-C	1/4"	12"	305	N	126
M380020-C	3/8"	3"	75	N	75
M380023-C	3/8"	5"	125	N	120
M380021-C	3/8"	6"	150	N	145
M380022-C	3/8"	10"	254	N	420
M380024-C	3/8"	20"	500	N	506
M120020-C	1/2"	2 1/2"	63.5	N	105
M120021-C	1/2"	5"	125	N	222
M120023-C	1/2"	6"	150	N	240
M120022-C	1/2"	10"	255	N	420
M120024-C	1/2"	20"	500	N	855
M340020-C	3/4"	4"	100	N	400
M340020S-C	3/4"	4"	100	Y	450
M340021-C	3/4"	8"	200	N	700
M340021S-C	3/4"	8"	200	Y	750
M340022-C	3/4"	16"	400	N	1400
M340022S-C	3/4"	16"	400	Y	1400
M110040	1"	8"	200	N	1350
M110050	1"	16"	400	N	2400



TT SERIES

x4

13 Pieces 1/4" 3/8" 1/2"

EXTENSION BARS SET TTX4 13 PIECES

- Includes a selection of long and wobble extension bars
- TengTools T-HD handle included for a more comfortable grip
- Designed and manufactured to DIN and ISO standards

1/4" Drive	6" & 12" Extension bars, Universal joint
3/8" Drive	3" Wobble extension bar, 20" Extension bar, Universal joint, 3/8" F x 1/4" M T-bar adaptor
1/2" Drive	3" Wobble extension bar, 20" Extension bar, Universal joint

T-handle grip, 2mm & 2.5mm Mini Hex Screwdrivers

Item ID: TTXEXT13



FOAM SERIES

x4

13 Pieces

EXTENSION BARS SET FOAMX4 13 PIECES

- Includes a selection of long and wobble extension bars
- TengTools T-HD handle included for a more comfortable grip
- Tools are held in place using three colour pre-cut EVA foam clearly showing where each tool belong
- Designed and manufactured to DIN and ISO standards

1/4" Drive	6" & 12" Extension bars, Universal joint
3/8" Drive	3" Wobble extension bar, 20" Extension bar, Universal joint, 3/8" F x 1/4" M T-bar adaptor
1/2" Drive	3" Wobble extension bar, 20" Extension bar, Universal joint

T-handle grip, 2mm & 2.5mm Mini Hex Screwdrivers

Item ID: TEXEXT13



UNIVERSAL JOINT

- Head rotates through 180° for use at different angles
- Ideal for use in confined spaces
- Chrome vanadium
- Satin finish for a better grip when handling sockets
- Ball bearing recess on the female end to grip the ratchet
- Ball bearing socket retainer on the male end to securely grip the socket
- Designed and manufactured to DIN3123C
- Supplied with a metal socket clip for use with a socket rail

ITEM ID:	Drive	Length mm	Safety Locking Screw	Weight g
M140030-C	1/4"	33	Y	23
M380030-C	3/8"	50	Y	65
M120030-C	1/2"	69	Y	165
M340030-C	3/4"	108	N	570



1/2"

1/2" FLEX HEAD ADAPTOR

- Use to convert an extension bar into a flex handle
- Head rotates through 180° for use at different angles
- Designed for extra torque to use with stubborn nuts and bolts
- Can also be used straight to transport fastenings more quickly
- Chrome vanadium
- Satin finish for a better grip when handling the adaptor
- Supplied with a metal socket clip for use with a socket rail

Item ID: **M120080-C**



ADAPTORS

- Made from chrome vanadium steel
- Satin finish for a better grip when handling sockets
- Ball bearing socket retainer on the male end to securely grip the socket
- Supplied with a metal socket clip for use with a socket rail

ITEM ID:	Drive	T-Drive Facility	Adaptor	Length mm	Weight g
M140036-C	1/4"	N	1/4"F - 3/8"M	25	20
M140037	1/4"	N	1/4"M - 1/4"Hex	25	7
M140039	1/4"	N	1/4"M - 1/4"Hex	30	10
M380035-C	3/8"	Y	3/8"F - 1/4"M	25.4	20
M380036-C	3/8"	Y	3/8"F - 1/2"M	36	45
M380037	3/8"	N	1/4"Hex - 3/8"M	32	14
M120036-C	1/2"	Y	1/2"F - 3/8"M	39.5	55
M120037-C	1/2"	N	1/2"F - 3/4"M	39.5	55
M340085-C	3/4"	N	3/4"F - 1"M	62	370
M340086-C	3/4"	Y	3/4"F - 1/2"M	40	164
M110030	1"	Y	1" T-Bar Adaptor	82	620



COUPLER ADAPTORS

- Coupler adaptors for holding various bits
- Chrome vanadium
- Satin finish for a better grip when handling the adaptor
- Retaining spring to hold the bit in place
- Designed and manufactured to DIN 3120
- Supplied with a metal socket clip for use with a socket rail

ITEM ID:	Drive	Coupler For	Length mm	Weight g
M140060-C	1/4"	1/4" Hex Bits	25	20
M380060-C	3/8"	1/4" Hex Bits	28	32
M380061-C	3/8"	10mm Hex Bits	28	32
M120060-C	1/2"	5/16" Hex Bits	38	88
M120061-C	1/2"	10mm Hex Bits	38	56
M120062-C	1/2"	12mm Hex Bits	38	62
M120063-C	1/2"	1/4" Hex Bits	25	88



TT SERIES

17 Pieces 1/4" 3/8" 1/2"

SOCKET ADAPTOR SET TTI 17 PIECES

- A selection of extension bars and adaptors in one handy set
- A full range of converters and adaptors from 1/4" to 1" drive
- Includes regular, magnetic and quick chuck holders for use with 1/4" hex bits
- Designed and manufactured to DIN standard

1/4" Drive:	1/4" Hex Coupler, Hex bit adaptor, 50mm Hex bit adaptor
3/8" Drive:	1/4" Hex Coupler, Hex bit adaptor, 50mm Hex bit adaptor
1/2" Drive:	50mm Hex bit adaptor
Step Up Adaptors:	1/4"F x 3/8"M 3/8" x 1/2"M
	1/2"F x 3/4"F 3/4"M - 1"F
Reducing Adaptors:	3/8"F x 1/4"M 1/2"F x 3/8"M
	3/4"F x 1/2"M
	50mm & 70mm Magnetic bit holder, 50mm Chuck bit holder with quick release

Item ID: **TTADP17**



INSERT ADAPTORS

- Quickly steps up from one drive to the next
- Magnets retain the socket in place
- Ideal for use where space is limited or where a regular adaptor is not suitable

ITEM ID:	Drive	Coupler For	Length mm	Weight g
M140036M	1/4"	1/4"F - 3/8"M	28	18
M380036M	3/8"	3/8"F - 1/2"M	30	30
M120037M	1/2"	1/2"F - 3/4"M	45	86
M340085M	3/4"	3/4"F - 1"M	54	130



4 Pieces

STEP UP ADAPTOR SET 4 PIECES

- 4 piece insert adaptor set
- Enables the use of smaller drive ratchets and accessories with larger sockets, etc.
- Magnets retain the socket in place
- Ideal for use where space is limited or where a regular adaptor is not suitable

Step Up Adaptors:	1/4"F x 3/8"M	3/8" x 1/2"M
	1/2"F x 3/4"F	3/4"M - 1"F

Item ID: **MX04**



SLIDING T BARS

- Use to create a T bar for fast transporting of the fastening
- Chrome vanadium
- Satin finish for a better grip when handling sockets
- Ball bearing socket retainer on the male end for secure grip
- Designed and manufactured to DIN3122A

ITEM ID:	Drive	Safety Lock	Length mm	Weight g
M140050-C	1/4"	N	106	40
M380050-C	3/8"	N	170	122
M120050-C	1/2"	N	243	300
M340050-C	3/4"	N	450	450
M340050S-C	3/4"	Y	450	450



T-BAR HANDLE

- T bar handle grip
- Plastic handle for use with T bars
- Use with TengTools extra long extension bars and 3/8"F:1/4"M T bar adaptors
- Creates a much more comfortable grip

Item ID: **T-HD**

1/4" DRIVE SOCKETS

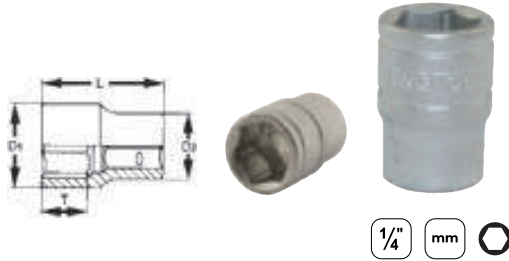

1/4" SOCKET 6 PT METRIC

- 6 point single hexagon socket for a better grip
- Chrome vanadium
- Satin finish for a better grip when handling the socket
- Ball bearing recess on the female end to grip the ratchet
- Designed and manufactured to DIN3120/3124 and ISO2725
- Supplied with a metal socket clip for use with a socket rail

ITEM ID:	Size mm	L mm	Tmin mm	D1 mm	D2 mm	Weight g
M140504-C	4	25	3.6	6.9	12	10
M1405045-C	4.5	25	3.6	7.5	12	12
M140505-C	5	25	4.2	8.1	12	12
M1405055-C	5.5	25	4.2	8.8	12	12
M140506-C	6	25	4.8	9.4	12	12
M140507-C	7	25	4	10.9	12	13
M140508-C	8	25	4	12	11.4	13
M140509-C	9	25	4.5	13.2	11.9	13
M140510-C	10	25	6	14.7	12.9	17
M140511-C	11	25	6	16	12.9	20
M140512-C	12	25	7	16.9	13.4	21
M140513-C	13	25	7.5	17.7	13.9	24

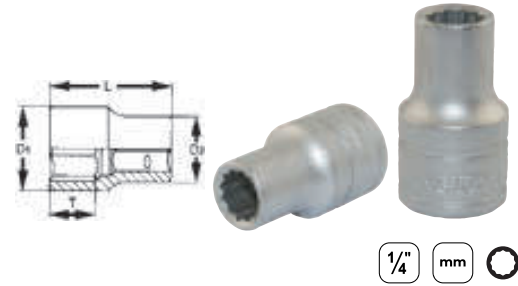

1/4" SOCKET 12 PT METRIC

- 12 point single hexagon socket for a better grip
- Chrome vanadium
- Satin finish for a better grip when handling the socket
- Ball bearing recess on the female end to grip the ratchet
- Designed and manufactured to DIN3120/3124 and ISO2725
- Supplied with a metal socket clip for use with a socket rail

ITEM ID:	Size mm	L mm	Tmin mm	D1 mm	D2 mm	Weight g
M14050412-C	4	25	3.6	6.9	12	10
M14050512-C	5	25	4.2	8.1	12	12
M140505512-C	5.5	25	4.2	8.8	12	12
M14050612-C	6	25	4.8	9.4	12	12
M14050712-C	7	25	4	10.9	12	13
M14050812-C	8	25	4	12	11.4	13
M14050912-C	9	25	4.5	13.2	11.9	13
M14051012-C	10	25	6	14.7	12.9	17
M14051112-C	11	25	6	16	12.9	20
M14051212-C	12	25	7	16.9	13.4	21
M14051312-C	13	25	7.5	17.7	13.9	24

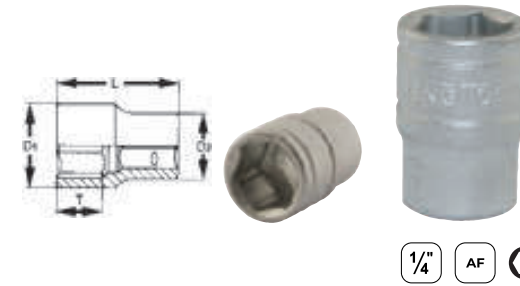

1/4" SOCKET 6 PT AF

- 6 point single hexagon socket for a better grip
- Chrome vanadium
- Satin finish for a better grip when handling the socket
- Ball bearing recess on the female end to grip the ratchet
- Designed and manufactured to DIN3120/3124 and ISO2725
- Supplied with a metal socket clip for use with a socket rail

ITEM ID:	Size AF	L mm	Tmin mm	D1 mm	D2 mm	Weight g
M140106-C	3/16"	25	3.6	8	12	12
M140107-C	7/32"	25	4.2	8.8	12	12
M140108-C	1/4"	25	4.8	10	12	12
M140109-C	9/32"	25	4	12	10.9	13
M140110-C	5/16"	25	4	12	11.4	13
M140111-C	11/32"	25	4.5	13.2	11.9	18
M140112-C	3/8"	25	4.5	14.4	12.4	19
M140114-C	7/16"	25	6	16	12.9	22
M140116-C	1/2"	25	7.2	17.7	13.9	28

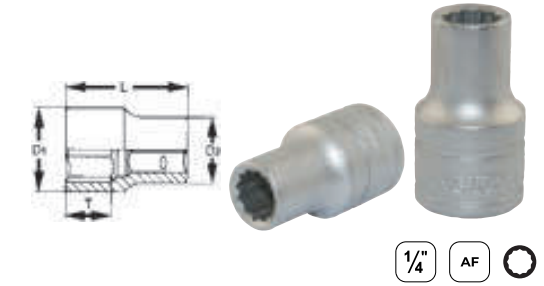

1/4" SOCKET 12 PT AF

- 12 point single hexagon socket for a better grip
- Chrome vanadium
- Satin finish for a better grip when handling the socket
- Ball bearing recess on the female end to grip the ratchet
- Designed and manufactured to DIN3120/3124 and ISO2725
- Supplied with a metal socket clip for use with a socket rail

ITEM ID:	Size AF	L mm	Tmin mm	D1 mm	D2 mm	Weight g
M14010612-C	3/16"	25	3.6	8	12	12
M14010712-C	7/32"	25	4.2	8.8	12	12
M14010812-C	1/4"	25	4.8	10	12	12
M14010912-C	9/32"	25	4	12	10.9	13
M14011012-C	5/16"	25	4	12	11.4	13
M14011112-C	11/32"	25	4.5	13.2	11.9	18
M14011212-C	3/8"	25	4.5	14.4	12.4	19
M14011412-C	7/16"	25	6	16	12.9	22
M14011612-C	1/2"	25	7.2	17.7	13.9	28



6-point sockets v 12-point sockets

12-point sockets, common in Aircraft Maintenance and Engineering, are ideal for use in confined space and for fast lightweight work. 6-point sockets are ideal for when extra torque needs to be applied. They are designed to contact the head of a fastener well away from the corners, this dramatically reduces the likelihood of slippage and rounding over of the corners.



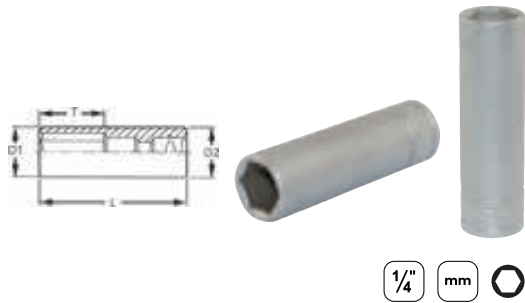

1/4" mm

1/4" DEEP SOCKET 6 PT METRIC

- 6 point single hexagon socket for a better grip
- Long sockets for extra reach
- Chrome vanadium
- Satin finish for a better grip when handling the socket
- Ball bearing recess on the female end to grip the ratchet
- Designed and manufactured to DIN3120/3124 and ISO2725
- Supplied with a metal socket clip for use with a socket rail

ITEM ID:	Size mm	L mm	Tmin mm	D1 mm	D2 mm	Weight g
M140604-C	4	49.5	5	6.9	11.8	23
M140605-C	5	49.5	5.5	8	11.8	25
M1406055-C	5.5	49.5	5.5	8.8	11.8	26
M140606-C	6	49.5	6.5	9.4	11.8	26
M140607-C	7	49.5	10.5	10.9	11.8	27
M140608-C	8	49.5	10.5	11.8	11.8	30
M140609-C	9	49.5	11.5	12.8	12.8	37
M140610-C	10	49.5	13	14.5	14.5	38
M140611-C	11	49.5	14	15.6	15.6	43
M140612-C	12	49.5	15	16.6	16.6	46
M140613-C	13	49.5	17	17.6	17.6	48

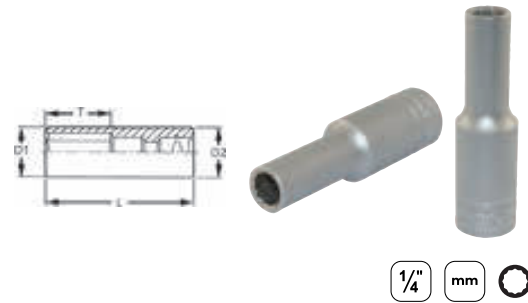

1/4" mm

1/4" DEEP SOCKET 12 PT METRIC

- 12 point single hexagon socket for a better grip
- Long sockets for extra reach
- Chrome vanadium
- Satin finish for a better grip when handling the socket
- Ball bearing recess on the female end to grip the ratchet
- Designed and manufactured to DIN3120/3124 and ISO2725
- Supplied with a metal socket clip for use with a socket rail

ITEM ID:	Size mm	L mm	Tmin mm	D1 mm	D2 mm	Weight g
M14060612-C	6	49.5	6.5	9.4	11.8	26
M14060712-C	7	49.5	10.5	10.9	11.8	27
M14060812-C	8	49.5	10.5	11.8	11.8	30
M14060912-C	9	49.5	11.5	12.8	12.8	37
M14061012-C	10	49.5	13	14.5	14.5	38
M14061112-C	11	49.5	14	15.6	15.6	43
M14061212-C	12	49.5	15	16.6	16.6	46
M14061312-C	13	49.5	17	17.6	17.6	48

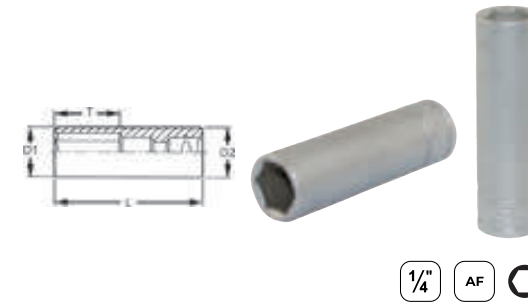

1/4" AF

1/4" DEEP SOCKET 6 PT AF

- 6 point single hexagon socket for a better grip
- Long sockets for extra reach
- Chrome vanadium
- Satin finish for a better grip when handling the socket
- Ball bearing recess on the female end to grip the ratchet
- Designed and manufactured to DIN3120/3124 and ISO2725
- Supplied with a metal socket clip for use with a socket rail

ITEM ID:	Size AF	L mm	Tmin mm	D1 mm	D2 mm	Weight g
M140206-C	3/16"	49.5	5	8	11.8	24
M140207-C	7/32"	49.5	5.5	9	11.8	26
M140208-C	1/4"	49.5	6.5	10	11.8	27
M140209-C	9/32"	49.5	10.5	11	11.8	26
M140210-C	5/16"	49.5	10.5	11.8	11.8	30
M140211-C	11/32"	49.5	11.5	12.8	11.8	34
M140212-C	3/8"	49.5	12.5	14.5	14.5	37
M140214-C	7/16"	49.5	14.5	15.6	15.6	44
M140216-C	1/2"	49.5	16.5	17.6	17.6	48

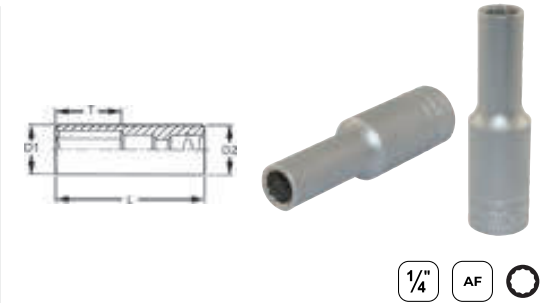

1/4" AF

1/4" DEEP SOCKET 12 PT AF

- 12 point single hexagon socket for a better grip
- Long sockets for extra reach
- Chrome vanadium
- Satin finish for a better grip when handling the socket
- Ball bearing recess on the female end to grip the ratchet
- Designed and manufactured to DIN3120/3124 and ISO2725
- Supplied with a metal socket clip for use with a socket rail

ITEM ID:	Size AF	L mm	Tmin mm	D1 mm	D2 mm	Weight g
M14020612-C	3/16"	49.5	5	8	11.8	24
M14020712-C	7/32"	49.5	5.5	9	11.8	26
M14020812-C	1/4"	49.5	6.5	10	11.8	27
M14020912-C	9/32"	49.5	10.5	11	11.8	26
M14021012-C	5/16"	49.5	10.5	11.8	11.8	30
M14021112-C	11/32"	49.5	11.5	12.8	11.8	34
M14021212-C	3/8"	49.5	12.5	14.5	14.5	37
M14021412-C	7/16"	49.5	14.5	15.6	15.6	44
M14021612-C	1/2"	49.5	16.5	17.6	17.6	48

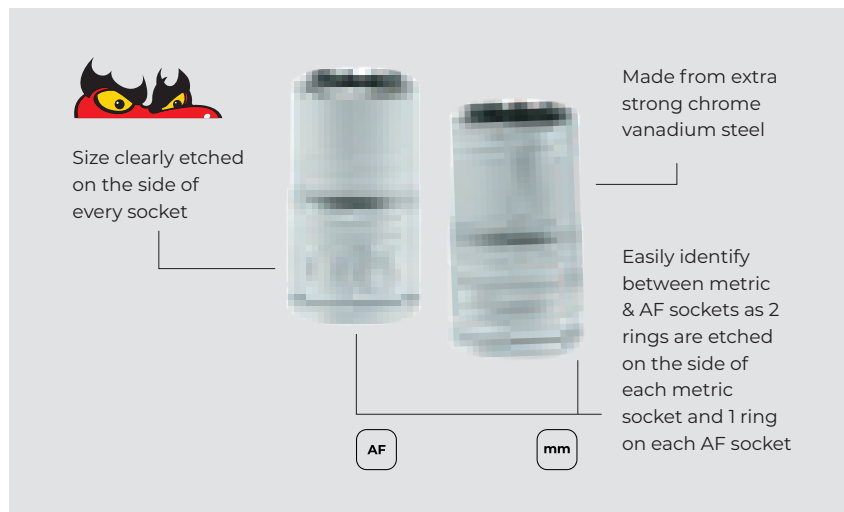

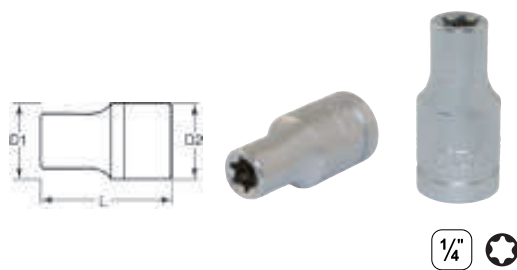

1/4" TX-E SOCKET

- Chrome vanadium
- Satin finish for a better grip when handling the socket
- Ball bearing recess on the female end to grip the ratchet
- Designed for use with protruding TX head screws
- Supplied with a metal socket clip for use with a socket rail

ITEM ID:	Size	Size mm	L mm	Tmin mm	D1 mm	D2 mm	Weight g
M140704-C	E4	3.83	23.1	3.5	5.8	12	7
M140705-C	E5	4.75	24.8	4.5	6.8	12	8
M140706-C	E6	5.74	24.8	4.5	8	12	9
M140707-C	E7	6.22	24.8	5.6	9.4	12	10
M140708-C	E8	7.52	24.8	6	10.4	12	10

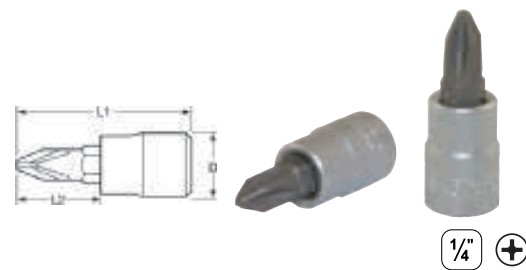

1/4" PH BIT SOCKET

- Chrome vanadium
- S2 steel bits pressed in to the socket
- Satin finish for a better grip when handling the socket
- Ball bearing recess on the female end to grip the ratchet
- Designed for use with Phillips type screws and fastenings
- Designed and manufactured to DIN 7422
- Supplied with a metal socket clip for use with a socket rail

ITEM ID:	Size	L1 mm	L2 mm	D mm	Weight g
M141300-C	PH0	32	15	12	13
M141301-C	PH1	32	15	12	13
M141302-C	PH2	32	15	12	13
M141303-C	PH3	32	15	12	13

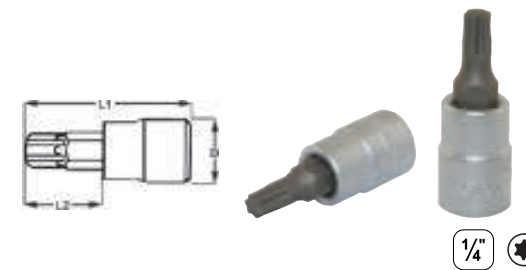

1/4" TX BIT SOCKET

- Chrome vanadium
- S2 steel bits pressed in to the socket
- Satin finish for a better grip when handling the socket
- Ball bearing recess on the female end to grip the ratchet
- Designed for use with fastenings with a TX hole
- Supplied with a metal socket clip for use with a socket rail

ITEM ID:	Size	Size mm	L1 mm	L2 mm	D mm	Weight g
M141210T-C	TX10	2.5	32	15	12	13
M141215T-C	TX15	3	32	15	12	13
M141220T-C	TX20	3.5	32	15	12	13
M141225T-C	TX25	4.5	32	15	12	13
M141227T-C	TX27	5	32	15	12	14
M141230T-C	TX30	5.5	32	15	12	14
M141240T-C	TX40	6.5	32	15	12	14

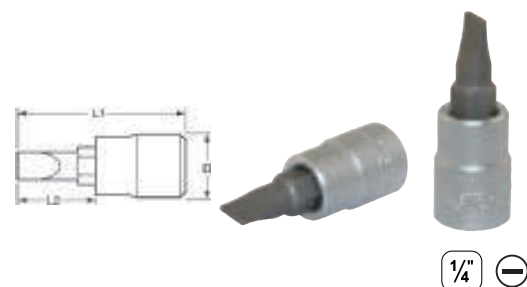

1/4" FLAT BIT SOCKET

- Chrome vanadium
- S2 steel bits pressed in to the socket
- Satin finish for a better grip when handling the socket
- Ball bearing recess on the female end to grip the ratchet
- Designed for use with slotted type screws and fastenings
- Designed and manufactured to DIN5264
- Supplied with a metal socket clip for use with a socket rail

ITEM ID:	Width mm	Thickness mm	L1 mm	L2 mm	D mm	Weight g
M141404-C	4	0.8	32	15	12	13
M1414055-C	5.5	1.0	32	15	12	13
M141407-C	7	1.4	32	15	12	14

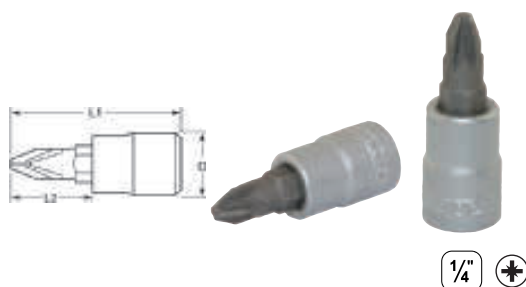

1/4" PZ BIT SOCKET

- Chrome vanadium
- S2 steel bits pressed in to the socket
- Satin finish for a better grip when handling the socket
- Ball bearing recess on the female end to grip the ratchet
- Designed for use with Pozi Drive type screws and fastenings
- Supplied with a metal socket clip for use with a socket rail

ITEM ID:	Size	L1 mm	L2 mm	D mm	Weight g
M141601-C	PZ1	32	15	12	13
M141602-C	PZ2	32	15	12	13
M141603-C	PZ3	32	15	12	13



3/8" DRIVE SOCKETS

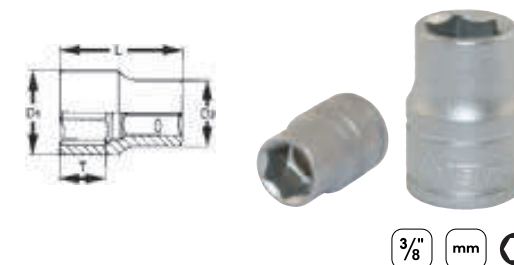

3/8" SOCKET 6 PT METRIC

- 6 point single hexagon socket for a better grip
- Chrome vanadium
- Satin finish for a better grip when handling the socket
- Ball bearing recess on the female end to grip the ratchet
- Designed and manufactured to DIN3120/3124 and ISO2725
- Supplied with a metal socket clip for use with a socket rail

ITEM ID:	Size mm	L mm	Tmin mm	D1 mm	D2 mm	Weight g
M380507-C	7	25.7	4	10.8	17.1	21
M380508-C	8	25.7	4.5	12	17.1	25
M380509-C	9	25.7	5	13.1	17.1	26
M380510-C	10	25.7	5	14.7	17.1	26
M380511-C	11	25.7	7	16	17.1	26
M380512-C	12	25.7	7	17.1	16.5	29
M380513-C	13	25.7	7	18.3	16.9	32
M380514-C	14	25.7	9	19.5	17.8	40
M380515-C	15	25.7	10	20.4	17.8	43
M380516-C	16	29	10	22.1	18.9	43
M380517-C	17	29	10	23.3	18.9	50
M380518-C	18	29	15.5	24.2	20	56
M380519-C	19	29	15.5	25.7	21	64
M380520-C	20	29	15.5	26.7	22	71
M380521-C	21	29	15.5	27.7	23	78
M380522-C	22	29	15.5	29.8	24	82

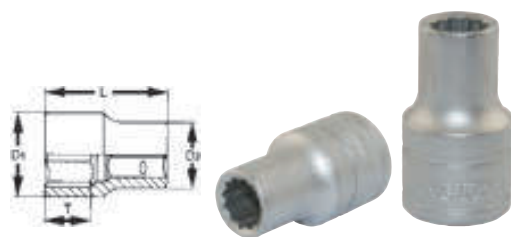

3/8" mm

3/8" SOCKET 12 PT METRIC

- 12 point single hexagon socket for a better grip
- Chrome vanadium
- Satin finish for a better grip when handling the socket
- Ball bearing recess on the female end to grip the ratchet
- Designed and manufactured to DIN3120/3124 and ISO2725
- Supplied with a metal socket clip for use with a socket rail

ITEM ID:	Size mm	L mm	Tmin mm	D1 mm	D2 mm	Weight g
M38050812-C	8	25.7	4.5	12	17.1	25
M38050912-C	9	25.7	5	13.1	17.1	26
M38051012-C	10	25.7	5	14.7	17.1	26
M38051112-C	11	25.7	7	16	17.1	26
M38051212-C	12	25.7	7	17.1	16.5	29
M38051312-C	13	25.7	7	18.3	16.9	32
M38051412-C	14	25.7	9	19.5	17.8	40
M38051512-C	15	25.7	10	20.4	17.8	43
M38051612-C	16	29	10	22.1	18.9	43
M38051712-C	17	29	10	23.3	18.9	50
M38051812-C	18	29	15.5	24.2	20	56
M38051912-C	19	29	15.5	25.7	21	64
M38052212-C	22	29	15.5	29.8	24	82

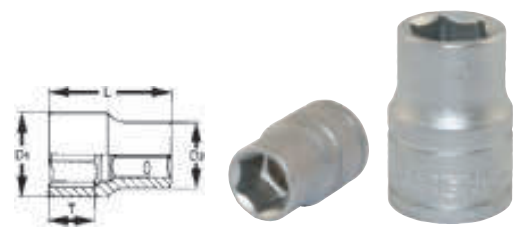

3/8" AF

3/8" SOCKET 6 PT AF

- 6 point single hexagon socket for a better grip
- Chrome vanadium
- Satin finish for a better grip when handling the socket
- Ball bearing recess on the female end to grip the ratchet
- Designed and manufactured to DIN3120/3124 and ISO2725
- Supplied with a metal socket clip for use with a socket rail

ITEM ID:	Size AF	L mm	Tmin mm	D1 mm	D2 mm	Weight g
M380110-C	5/16"	25.7	4.5	11.7	17.1	23
M380112-C	3/8"	25.7	5	14.2	17.1	24
M380114-C	7/16"	25.7	7	16.3	17.1	26
M380116-C	1/2"	25.7	7	18.3	16.9	34
M380118-C	9/16"	25.7	9	19.5	17.8	38
M380120-C	5/8"	29	10	22.1	18.9	46
M380122-C	11/16"	29	10	24.2	20	50
M380124-C	3/4"	29	12	25.7	21	60
M380126-C	13/16"	29	13	27.7	23	68
M380128-C	7/8"	29	13	29.5	24	75

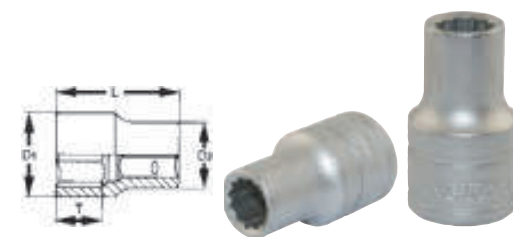

3/8" AF

3/8" SOCKET 12 PT AF

- 12 point single hexagon socket for a better grip
- Chrome vanadium
- Satin finish for a better grip when handling the socket
- Ball bearing recess on the female end to grip the ratchet
- Designed and manufactured to DIN3120/3124 and ISO2725
- Supplied with a metal socket clip for use with a socket rail

ITEM ID:	Size AF	L mm	Tmin mm	D1 mm	D2 mm	Weight g
M38011212-C	3/8"	25.7	5	14.2	17.1	24
M38011412-C	7/16"	25.7	7	16.3	17.1	26
M38011612-C	1/2"	25.7	7	18.3	16.9	34
M38011812-C	9/16"	25.7	9	19.5	17.8	38
M38012012-C	5/8"	29	10	22.1	18.9	46
M38012212-C	11/16"	29	10	24.2	20	50
M38012412-C	3/4"	29	12	25.7	21	60

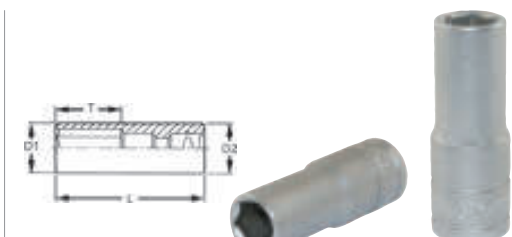

3/8" mm

3/8" DEEP SOCKET 6 PT METRIC

- 6 point single hexagon socket for a better grip
- Long sockets for extra reach
- Chrome vanadium
- Satin finish for a better grip when handling the socket
- Ball bearing recess on the female end to grip the ratchet
- Designed and manufactured to DIN3120/3124 and ISO2725
- Supplied with a metal socket clip for use with a socket rail

ITEM ID:	Size mm	L mm	Tmin mm	D1 mm	D2 mm	Weight g
M380607-C	7	45.5	10	10.8	16.5	40
M380608-C	8	45.5	12	12	16.5	50
M380609-C	9	45.5	14	13.1	16.5	55
M380610-C	10	45.5	15	14.7	16.5	60
M380611-C	11	45.5	17	16.5	16.5	70
M380612-C	12	45.5	18	17.1	17.1	75
M380613-C	13	45.5	18	18.5	18.5	85
M380614-C	14	50	18	19.5	19.5	95
M380615-C	15	53	20	20.4	20.4	100
M380616-C	16	53	20	22	22	105
M380617-C	17	56	20	23.3	23.3	120
M380618-C	18	56	20	24.2	24.2	125
M380619-C	19	56	20	25.7	25.7	130
M380620-C	20	63.5	22	26.8	26.8	140
M380621-C	21	63.5	22	27.7	27.7	165
M380622-C	22	63.5	22	29.5	29.5	165

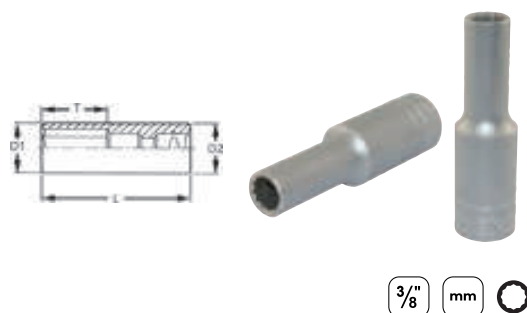

3/8" mm

3/8" DEEP SOCKET 12 PT METRIC

- 12 point single hexagon socket for a better grip
- Long sockets for extra reach
- Chrome vanadium
- Satin finish for a better grip when handling the socket
- Ball bearing recess on the female end to grip the ratchet
- Designed and manufactured to DIN3120/3124 and ISO2725
- Supplied with a metal socket clip for use with a socket rail

ITEM ID:	Size mm	L mm	Tmin mm	D1 mm	D2 mm	Weight g
M38060712-C	7	45.5	10	10.8	16.5	40
M38060812-C	8	45.5	12	12	16.5	50
M38060912-C	9	45.5	14	13.1	16.5	55
M38061012-C	10	45.5	15	14.7	16.5	60
M38061112-C	11	45.5	17	16	16.5	70
M38061212-C	12	45.5	18	17.1	17.1	75
M38061312-C	13	45.5	18	18.5	18.5	85
M38061412-C	14	50	18	19.5	19.5	95
M38061512-C	15	53	20	20.4	20.4	100
M38061612-C	16	53	20	22	22	105
M38061712-C	17	56	20	23.3	23.3	120
M38061812-C	18	56	20	24.2	24.2	125
M38061912-C	19	56	20	25.7	25.7	130
M38062012-C	20	63.5	22	26.8	26.8	140
M38062112-C	21	63.5	22	27.7	27.7	165
M38062212-C	22	63.5	22	29.5	29.5	165

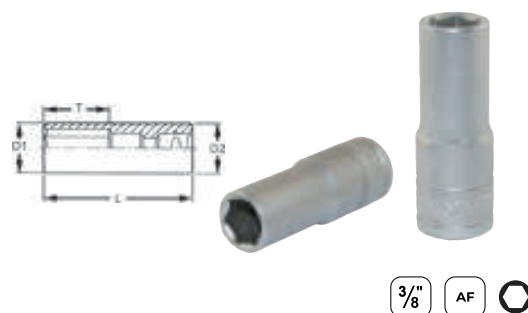

3/8" AF

3/8" DEEP SOCKET 6 PT AF

- 6 point single hexagon socket for a better grip
- Long sockets for extra reach
- Chrome vanadium
- Satin finish for a better grip when handling the socket
- Ball bearing recess on the female end to grip the ratchet
- Designed and manufactured to DIN3120/3124 and ISO2725
- Supplied with a metal socket clip for use with a socket rail

ITEM ID:	Size AF	L mm	Tmin mm	D1 mm	D2 mm	Weight g
M380212-C	3/8"	45.5	15	14.2	16.5	43
M380214-C	7/16"	45.5	17	16.5	16.5	50
M380216-C	1/2"	45.5	18	18.5	18.5	62
M380218-C	9/16"	50	18	19.5	19.5	72
M380220-C	5/8"	53	20	22	22	97
M380222-C	11/16"	56	20	24.2	24.2	125
M380224-C	3/4"	56	22	25.7	25.7	130
M380226-C	13/16"	63.5	22	27.7	27.7	140
M380228-C	7/8"	63.5	22	29.5	29.5	165

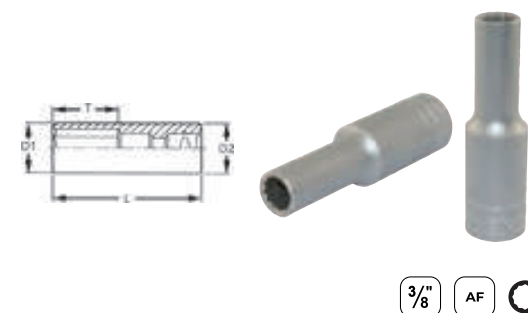

3/8" AF

3/8" DEEP SOCKET 12 PT AF

- 12 point single hexagon socket for a better grip
- Long sockets for extra reach
- Chrome vanadium
- Satin finish for a better grip when handling the socket
- Ball bearing recess on the female end to grip the ratchet
- Designed and manufactured to DIN3120/3124 and ISO2725
- Supplied with a metal socket clip for use with a socket rail

ITEM ID:	Size AF	L mm	Tmin mm	D1 mm	D2 mm	Weight g
M38021212-C	3/8"	45.5	15	14.2	16.5	43
M38021412-C	7/16"	45.5	17	16.5	16.5	50
M38021612-C	1/2"	45.5	18	18.5	18.5	62
M38021812-C	9/16"	50	18	19.5	19.5	72
M38022012-C	5/8"	53	20	22	22	97
M38022212-C	11/16"	56	20	24.2	24.2	125
M38022412-C	3/4"	56	22	25.7	25.7	130



"Hip Grip"

All sockets are produced according to TengTools "hip grip" system, which means the socket grips on the flat surfaces of the nut rather than on the corner. This system helps to prevent damage to nuts and bolts and makes it possible to grip nuts and bolts which already have damaged corners.

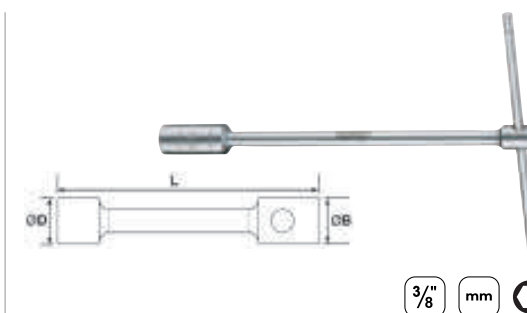

3/8" mm

3/8" T-BAR DEEP SOCKET 6 PT METRIC

- 6 point single hexagon socket for a better grip
- Extra long sockets for extra reach
- Chrome vanadium
- Satin finish for a better grip when handling the socket
- Supplied with a sliding T bar for quicker tightening & loosening

ITEM ID:	Size mm	L mm	D mm	Weight g
TBSKT07	7	300	10	200
TBSKT08	8	300	10	200
TBSKT10	10	300	10	220
TBSKT12	12	300	10	240
TBSKT13	13	300	10	240
TBSKT14	14	300	10	240
TBSKT17	17	300	12	340
TBSKT19	19	300	12	360
T-HD01	200mm x 8mm Replacement bar for use with T-bar sockets			



TT
SERIES
x4

9 Pieces 3/8" mm

3/8" LONG T BAR SOCKET SET TTX4 9 PIECES

- Extra long socket set
- 3/8" drive extra long sockets for use in hard to reach places
- T bar with the TengTools T-HD handle for more comfortable use

2 Piece T-bar handle

3/8" Drive extra long sockets:

mm: 8 10 12 13 14 17 19

Item ID: **TTXTB09**



10 Pieces 3/8" mm

3/8" DEEP T BAR SOCKET SET 10 PIECES

- Extra long sockets for extra reach
- 6 point single hexagon socket for a better grip
- T bar with the TengTools T-HD handle for more comfortable use
- Chrome vanadium satin finish for a better grip
- Supplied with a sliding T bar for quicker tightening & loosening
- Supplied in a handy tool roll style wallet

2 Piece T-bar handle

300mm long deep sockets:

mm: 7 8 10 12 13 14 17 19

Item ID: **TBW10**

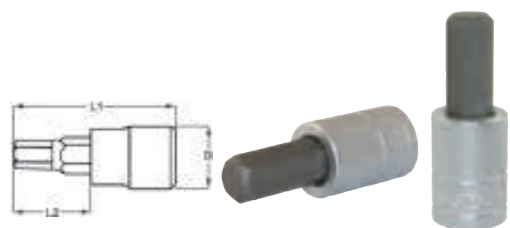

3/8" mm

3/8" HEX BIT SOCKET METRIC

- Chrome vanadium
- S2 steel bits pressed in to the socket
- Satin finish for a better grip when handling the socket
- Ball bearing recess on the female end to grip the ratchet
- Designed for use with fastenings with a hexagon hole
- Use with in-hex screws or grub screws
- Designed and manufactured to DIN7422
- Supplied with a metal socket clip for use with a socket rail

ITEM ID:	Size mm	L1 mm	L2 mm	D mm	Weight g
M381503-C	3	49.5	23	17.9	36
M381504-C	4	49.5	23	17.9	37
M381505-C	5	49.5	23	17.9	38
M381505S-C	5.5	49.5	23	17.9	38
M381506-C	6	49.5	23	17.9	38
M381507-C	7	49.5	23	17.9	38
M381508-C	8	49.5	23	17.9	40
M381510-C	10	49.5	23	17.9	52
M381512-C	12	49.5	23	22	56

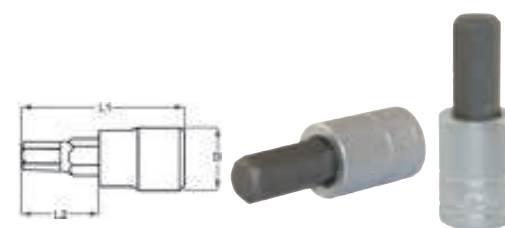

3/8" AF

3/8" HEX BIT SOCKET AF

- Chrome vanadium
- S2 steel bits pressed in to the socket
- Satin finish for a better grip when handling the socket
- Ball bearing recess on the female end to grip the ratchet
- Designed for use with fastenings with a hexagon hole
- Use with in-hex screws or grub screws
- Designed and manufactured to DIN7422
- Supplied with a metal socket clip for use with a socket rail

ITEM ID:	Size AF	L1 mm	L2 mm	D mm	Weight g
M381103-C	3/32"	49.5	23	17.9	36
M381104-C	1/8"	49.5	23	17.9	36
M381105-C	5/32"	49.5	23	17.9	38
M381106-C	3/16"	49.5	23	17.9	38
M381107-C	7/32"	49.5	23	17.9	38
M381108-C	1/4"	49.5	23	17.9	40
M381110-C	5/16"	49.5	23	17.9	40
M381112-C	3/8"	49.5	23	17.9	42

NEW



3/8" mm

3/8" HEX BIT SOCKET METRIC 100MM

- Chrome vanadium
- S2 steel bits pressed into the socket
- Satin finish for a better grip when handling the socket
- Ball recess on the female end to grip the ratchet
- Designed for use with fastenings with a hexagon hole
- Use with in-hex screws or grub screws
- Designed and manufactured to DIN7422
- Supplied with a metal socket clip for use with a socket rail

ITEM ID:	Size mm	L1 mm	L2 mm	D mm	Weight g
M382503-C	3	100	74	17.9	48
M382504-C	4	100	74	17.9	50
M382505S-C	5	100	74	17.9	50
M382505-C	5.5	100	74	17.9	50
M382506-C	6	100	74	17.9	50
M382507-C	7	100	74	17.9	55
M382508-C	8	100	74	17.9	66
M382510-C	10	100	74	17.9	86
M382512-C	12	100	74	17.9	130

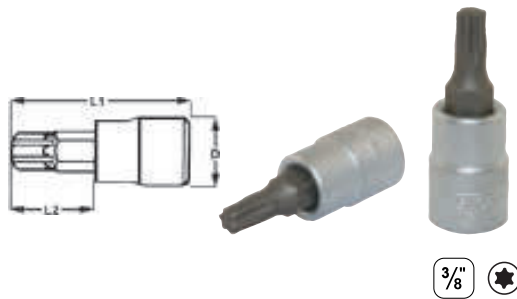

3/8" TX BIT SOCKET

- Chrome vanadium
- S2 steel bits pressed in to the socket
- Satin finish for a better grip when handling the socket
- Ball bearing recess on the female end to grip the ratchet
- Designed for use with fastenings with a TX hole
- Supplied with a metal socket clip for use with a socket rail

ITEM ID:	Size	Size mm	L1 mm	L2 mm	D mm	Weight g
M381210T-C	TX10	2.5	49.5	23	17.9	36
M381215T-C	TX15	3	49.5	23	17.9	36
M381220T-C	TX20	3.5	49.5	23	17.9	36
M381225T-C	TX25	4.5	49.5	23	17.9	36
M381227T-C	TX27	5	49.5	23	17.9	37
M381230T-C	TX30	5.5	49.5	23	17.9	37
M381240T-C	TX40	6.5	49.5	23	17.9	40
M381245T-C	TX45	7.5	49.5	23	17.9	45
M381250T-C	TX50	8.8	49.5	23	17.9	50

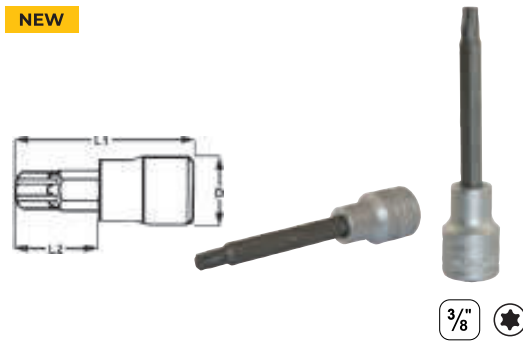

3/8" TX BIT SOCKET 100MM

- Chrome vanadium
- S2 steel bits pressed into the socket
- Satin finish for a better grip when handling the socket
- Ball recess on the female end to grip the ratchet
- Designed for use with fastenings with a TX hole
- Supplied with a metal socket clip for use with a socket rail

ITEM ID:	Size	Size mm	L1 mm	L2 mm	D mm	Weight g
M382210T-C	TX10	2.5	100	74	17.9	48
M382215T-C	TX15	3	100	74	17.9	48
M382220T-C	TX20	3.5	100	74	17.9	50
M382225T-C	TX25	4.5	100	74	17.9	50
M382227T-C	TX27	5	100	74	17.9	50
M382230T-C	TX30	5.5	100	74	17.9	50
M382240T-C	TX40	6.5	100	74	17.9	50
M382245T-C	TX45	7.5	100	74	17.9	65
M382250T-C	TX50	8.8	100	74	17.9	65



Do's and Don'ts of Socketry

Do's

- Use the right drive
- Use the correct socket size
- Check the thread direction
- Keep it clean and dry
- Use light oil on ratchet mechanisms

Don't's

- Do not use with impact tools
- Do not use TPX on a TX fastenings
- Do not use poles to increase leverage

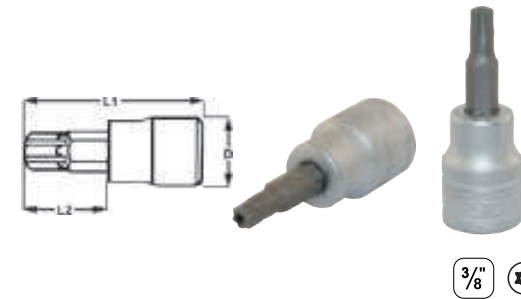

3/8" TPX BIT SOCKET

- Chrome vanadium
- S2 steel bits pressed in to the socket
- Satin finish for a better grip when handling the socket
- Ball bearing recess on the female end to grip the ratchet
- Designed for use with fastenings with a TX hole with a security pin
- Supplied with a metal socket clip for use with a socket rail

ITEM ID:	Size	Size mm	L1 mm	L2 mm	D mm	Weight g
M381210-C	TPX10	2.5	49.5	23	17.9	36
M381215-C	TPX15	3	49.5	23	17.9	36
M381220-C	TPX20	3.5	49.5	23	17.9	36
M381225-C	TPX25	4.5	49.5	23	17.9	36
M381227-C	TPX27	5	49.5	23	17.9	37
M381230-C	TPX30	5.5	49.5	23	17.9	37
M381240-C	TPX40	6.5	49.5	23	17.9	40
M381245-C	TPX45	7.5	49.5	23	17.9	45
M381250-C	TPX50	8.8	49.5	23	17.9	50

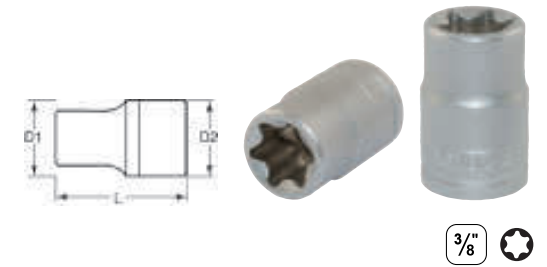

3/8" TX-E SOCKET

- Chrome vanadium
- Satin finish for a better grip when handling the socket
- Ball bearing recess on the female end to grip the ratchet
- Designed for use with protruding TX head screws
- Supplied with a metal socket clip for use with a socket rail

ITEM ID:	Size	Size mm	L mm	Tmin mm	D1 mm	D2 mm	Weight g
M380710-C	E10	9.42	28	7.2	13	17	25
M380712-C	E12	11.17	28	7.7	15	17	25
M380714-C	E14	12.9	28	9.6	16.3	18	30
M380716-C	E16	14.76	28	10.8	20	20	35
M380718-C	E18	16.7	28	12	22	22	40

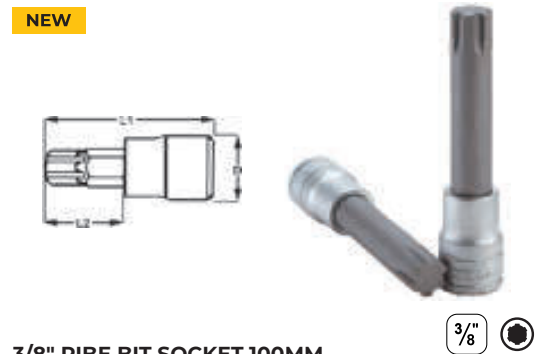

3/8" RIBE BIT SOCKET 100MM

- Chrome vanadium
- S2 steel bits pressed into the socket
- Satin finish for a better grip when handling the socket
- Ball recess on the female end to grip the ratchet
- Designed for use with fastenings with a multi spline Ribe type hole
- Supplied with a metal socket clip for use with a socket rail

ITEM ID:	Size	L1 mm	L2 mm	D mm	Weight g
M382704-C	04	100	74	17.9	40
M382705-C	05	100	74	17.9	43
M382706-C	06	100	74	17.9	47
M382708-C	08	100	74	17.9	60
M382709-C	09	100	74	17.9	68
M382710-C	10	100	74	17.9	75



3/8" mm

3/8" CROW FOOT WRENCH

- Open ended spanner at right angle to square drive
- Ideal for accessing confined spaces
- Use with a ratchet or torque wrench with an extension bar
- Satin finish chrome vanadium
- Supplied with a metal socket clip for use with a socket rail

ITEM ID:	Size mm	L mm	H mm	D mm	Weight g
M386510-C	10	32.3	4.8	21.3	36
M386511-C	11	34.3	5.2	23.1	50
M386512-C	12	36.2	5.6	25.5	58
M386513-C	13	37.4	6	26.9	70
M386514-C	14	40	6.2	30.2	86
M386515-C	15	41.3	6.7	33.3	90
M386516-C	16	41.3	6.7	33.3	114
M386517-C	17	45.5	8.5	38.1	116
M386518-C	18	45.5	8.5	38.1	140
M386519-C	19	47.6	8.5	39.6	168



8 Pieces 3/8" mm

3/8" CROW FOOT WRENCH CLIP RAIL SET

- Open ended spanner at right angle to square drive
- Ideal for accessing confined spaces
- Use with a ratchet or torque wrench with an extension bar
- Satin finish chrome vanadium
- Supplied with a clip rail with socket clips for easy storage

3/8" Drive Crow Foot Wrenches
10, 11, 12, 13, 16, 17, 18, 19 mm

Item ID: **M3808MM**

1/2" DRIVE SOCKETS

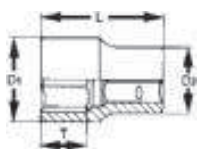

1/2" mm

1/2" SOCKET 6 PT METRIC

- 6 point single hexagon socket for a better grip
- Chrome vanadium
- Satin finish for a better grip when handling the socket
- Ball bearing recess on the female end to grip the ratchet
- Designed and manufactured to DIN3120/3124 and ISO2725
- Supplied with a metal socket clip for use with a socket rail

ITEM ID:	Size mm	L mm	Tmin mm	D1 mm	D2 mm	Weight g
M1205086-C	8	38	10	12.4	21.8	45
M1205106-C	10	38	10	15.5	21.8	45
M1205116-C	11	38	10	16.7	21.8	47
M1205126-C	12	38	10	18	21.8	49
M1205136-C	13	38	10	19.2	21.8	50
M1205146-C	14	38	10	20.5	21.8	50
M1205156-C	15	38	14	21	21.8	51
M1205166-C	16	38	14.3	22.5	23.3	55
M1205176-C	17	38	14.3	24.2	23	57
M1205186-C	18	38	15.3	24.7	23	61
M1205196-C	19	38	16.7	26.3	24	63
M1205206-C	20	38	17.3	27	24	66
M1205216-C	21	38	18	28	24	71
M1205226-C	22	40	18	29.8	26	97
M1205236-C	23	40	18	30.8	27	96
M1205246-C	24	40	18	31.8	26	93
M1205256-C	25	40	20	33.4	28	136
M1205266-C	26	40	20	34.8	29	140
M1205276-C	27	43	20	35.8	30	148
M1205286-C	28	43	20	37.8	31	172
M1205296-C	29	43	20	38.8	32	180
M1205306-C	30	43	20	39.8	33	180
M1205326-C	32	43	22	41.8	35	201
M1205336-C	33	45.5	23.5	42.8	35	235
M1205346-C	34	45.5	23.5	43.8	36	223

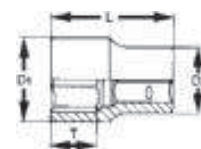

1/2" mm

1/2" SOCKET 12 PT METRIC

- 12 point bi-hexagon socket for easier alignment
- Chrome vanadium
- Satin finish for a better grip when handling the socket
- Ball bearing recess on the female end to grip the ratchet
- Designed and manufactured to DIN3120/3124 and ISO2725
- Supplied with a metal socket clip for use with a socket rail

ITEM ID:	Size mm	L mm	Tmin mm	D1 mm	D2 mm	Weight g
M120508-C	8	38	9	13	21.8	43
M120509-C	9	38	10	14.5	21.8	45
M120510-C	10	38	10	15.5	21.8	45
M120511-C	11	38	10	16.7	21.8	47
M120512-C	12	38	10	18	21.8	49
M120513-C	13	38	10	19.2	21.8	50
M120514-C	14	38	10	20.5	21.8	50
M120515-C	15	38	14	21	21.8	51
M120516-C	16	38	14.3	22.5	23.3	55
M120517-C	17	38	15.3	24.2	23	57
M120518-C	18	38	16.7	24.7	23	61
M120519-C	19	38	17.3	26.3	24	63
M120520-C	20	38	18	27	23.7	66
M120521-C	21	38	18	28	24	68
M120522-C	22	40	18	29.8	26	92
M120523-C	23	40	18	30.8	27	92
M120524-C	24	40	20	31.8	26	95
M120525-C	25	40	20	33.4	28	136
M120526-C	26	40	20	34.8	29	140
M120527-C	27	43	20	35.8	30	148
M120528-C	28	43	20	37.8	31	172
M120529-C	29	43	20	38.8	32	180
M120530-C	30	43	22	39.8	33	172
M120532-C	32	43	23	41.8	35	189
M120534-C	34	45.5	23	43.8	36	223

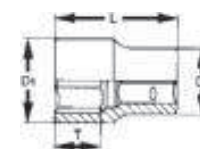

1/2" AF

1/2" SOCKET 12 PT AF

- 12 point bi-hexagon socket for easier alignment
- Chrome vanadium
- Satin finish for a better grip when handling the socket
- Ball bearing recess on the female end to grip the ratchet
- Designed and manufactured to DIN3120/3124 and ISO2725
- Supplied with a metal socket clip for use with a socket rail

ITEM ID:	Size AF	L mm	Tmin mm	D1 mm	D2 mm	Weight g
M120112-C	3/8"	38	9	14.7	21.8	46
M120114-C	7/16"	38	9	17	21.8	50
M120116-C	1/2"	38	10	19	21.8	52
M120118-C	9/16"	38	12.5	20.8	21.8	55
M120119-C	19/32"	38	16	21	21.8	51
M120120-C	5/8"	38	14.3	22.5	23.3	62
M120122-C	11/16"	38	14.3	24.2	23.5	72
M120124-C	3/4"	38	20	26.3	24	76
M120125-C	25/32"	38	16	26.8	24	66
M120126-C	13/16"	38	20	27.7	24	80
M120128-C	7/8"	40	21	29.8	26	95
M120130-C	15/16"	40	21	31.8	26	110
M120132-C	1"	43	21	33.8	27.5	120
M120134-C	1-1/16"	43	23	35.8	29	145
M120136-C	1-1/8"	43	23	37.8	30.5	150
M120138-C	1-3/16"	43	23	39.8	32.5	190
M120140-C	1-1/4"	43	23	40.8	34	205

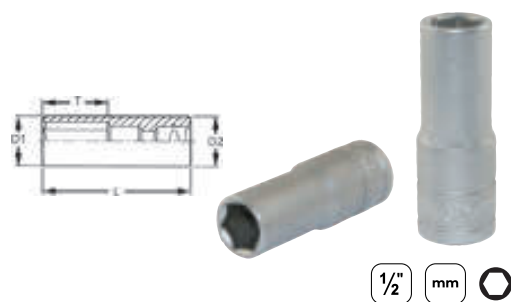

1/2" DEEP SOCKET 6 PT METRIC

- 6 point single hexagon socket for a better grip
- Chrome vanadium
- Satin finish for a better grip when handling the socket
- Ball bearing recess on the female end to grip the ratchet
- Designed and manufactured to DIN3120/3124 and ISO2725
- Supplied with a metal socket clip for use with a socket rail

ITEM ID:	Size mm	L mm	Tmin mm	D1 mm	D2 mm	Weight g
M1206136-C	13	79	21	19.2	22	135
M1206146-C	14	79	25	20.5	22	135
M1206156-C	15	79	28	21.5	22	135
M1206166-C	16	79	31	22.5	23.3	150
M1206176-C	17	79	34	24.2	24.2	155
M1206186-C	18	79	34	25.4	25.4	165
M1206196-C	19	79	34	26.7	26.7	190
M1206246-C	24	79	34	31.8	31.8	240

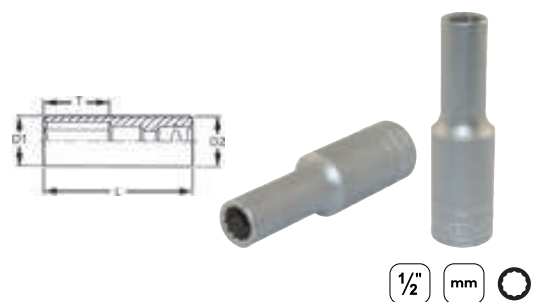

1/2" DEEP SOCKET 12 PT METRIC

- 12 point bi-hexagon socket for easier alignment
- Chrome vanadium
- Satin finish for a better grip when handling the socket
- Ball bearing recess on the female end to grip the ratchet
- Designed and manufactured to DIN3120/3124 and ISO2725
- Supplied with a metal socket clip for use with a socket rail

ITEM ID:	Size mm	L mm	Tmin mm	D1 mm	D2 mm	Weight g
M120610-C	10	79	17	15.5	22	125
M120611-C	11	79	18	16.7	22	130
M120612-C	12	79	19	18	22	130
M120613-C	13	79	21	19.2	22	135
M120614-C	14	79	25	20.5	22	135
M120615-C	15	79	28	21.5	22	135
M120616-C	16	79	31	22.5	23.3	150
M120617-C	17	79	24	24.2	24.2	155
M120618-C	18	79	34	25.4	25.4	165
M120619-C	19	79	34	26.7	26.7	190
M120620-C	20	79	34	27.8	27.8	195
M120621-C	21	79	34	27.8	27.8	184
M120622-C	22	79	34	29.8	29.8	230
M120624-C	24	79	34	31.8	31.8	240
M120627-C	27	79	34	35.8	35.8	280
M120630-C	30	79	34	39.8	39.8	360
M120632-C	32	79	34	41.3	41.3	380
M120636-C	36	79	34	46	46	390



1/2" TX-E SOCKET

- Chrome vanadium
- Satin finish for a better grip when handling the socket
- Ball bearing recess on the female end to grip the ratchet
- Designed for use with protruding TX head screws
- Supplied with a metal socket clip for use with a socket rail

ITEM ID:	Size	L mm	Tmin mm	D1 mm	D2 mm	Weight g
M120710-C	E10	9.42	37.8	9.5	13.1	39
M120711-C	E11	10.08	37.8	9.5	14.1	42
M120712-C	E12	11.17	37.8	9.5	14.9	43
M120714-C	E14	12.9	37.8	12.3	16.7	44
M120716-C	E16	14.76	37.8	13	19.1	49
M120718-C	E18	16.7	37.8	13	20.9	52
M120720-C	E20	18.45	37.8	13	23.7	60
M120722-C	E22	20.3	37.8	16.1	26.1	82
M120724-C	E24	22.16	37.8	16.4	28	102

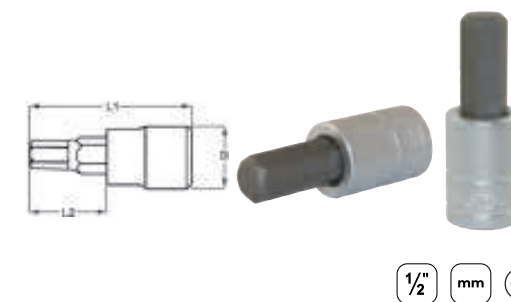

1/2" HEX BIT SOCKET METRIC

- Chrome vanadium
- S2 steel bits pressed in to the socket
- Satin finish for a better grip when handling the socket
- Ball bearing recess on the female end to grip the ratchet
- Designed for use with fastenings with a hexagon hole
- Use with in-hex screws or grub screws
- Designed and manufactured to DIN7422
- Supplied with a metal socket clip for use with a socket rail

ITEM ID:	Size mm	L1 mm	L2 mm	D mm	Weight g
M121505-C	5	55	20.5	22	52
M121506-C	6	55	20.5	22	54
M121507-C	7	55	20.5	22	60
M121508-C	8	55	20.5	22	62
M121509-C	9	55	20.5	22	66
M121510-C	10	55	20.5	22	72
M121512-C	12	55	20.5	22	80
M121514-C	14	55	20.5	22	96
M121515-C	15	55	35	22	105
M121516-C	16	55	35	25	130
M121517-C	17	55	20.5	25	154
M121518-C	18	55	38	28	140
M121519-C	19	60	23	25.9	182

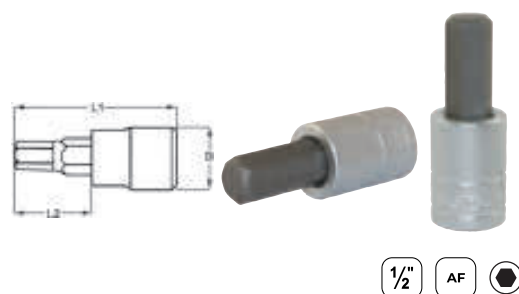

1/2" AF

1/2" HEX BIT SOCKET AF

- Chrome vanadium
- S2 steel bits pressed in to the socket
- Satin finish for a better grip when handling the socket
- Ball bearing recess on the female end to grip the ratchet
- Designed for use with fastenings with a hexagon hole
- Use with in-hex screws or grub screws
- Designed and manufactured to DIN7422
- Supplied with a metal socket clip for use with a socket rail

ITEM ID:	Size AF	L1 mm	L2 mm	D mm	Weight g
M121106-C	3/16"	55	20	22	55
M121107-C	7/32"	55	20	22	55
M121108-C	1/4"	55	20	22	55
M121109-C	9/32"	55	20	22	60
M121110-C	5/16"	55	20	22	62
M121112-C	3/8"	55	20	22	67
M121116-C	1/2"	55	20	22	85
M121118-C	9/16"	55	20	22	100
M121120-C	5/8"	55	20	22	120



1/2" mm

1/2" LONG HEX BIT SOCKET METRIC

- Chrome vanadium
- S2 steel bits pressed in to the socket
- Satin finish for a better grip when handling the socket
- Ball bearing recess on the female end to grip the ratchet
- Designed for use with fastenings with a hexagon hole
- Use with in-hex screws or grub screws
- Designed and manufactured to DIN7422
- Supplied with a metal socket clip for use with a socket rail

ITEM ID:	Size mm	L1 mm	L2 mm	D mm	Weight g
M122505-C	5	100	65.5	22	60
M122506-C	6	100	65.5	22	60
M122506A-C	6	115	80	22	100
M122507-C	7	100	65.5	22	80
M122508-C	8	100	65.5	22	80
M122508A-C	8	115	80	22	120
M122510-C	10	100	65.5	22	100
M122510L-C	10	175	140	22	150
M122512-C	12	100	65.5	22	120
M122514-C	14	100	65.5	22	153
M122517-C	17	100	65.5	25	225

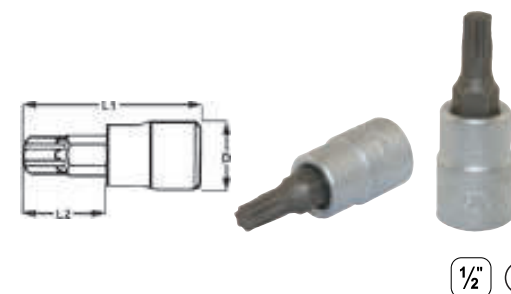

1/2"

1/2" TX BIT SOCKET

- Chrome vanadium
- S2 steel bits pressed in to the socket
- Satin finish for a better grip when handling the socket
- Ball bearing recess on the female end to grip the ratchet
- Designed for use with fastenings with a TX hole
- Supplied with a metal socket clip for use with a socket rail

ITEM ID:	Size	L1 mm	L2 mm	D mm	Weight g
M121220T-C	TX20	55	20.5	22	64
M121225T-C	TX25	55	20.5	22	64
M121227T-C	TX27	55	20.5	22	64
M121230T-C	TX30	55	20.5	22	64
M121240T-C	TX40	55	20.5	22	64
M121245T-C	TX45	55	20.5	22	74
M121250T-C	TX50	55	20.5	22	74
M121255T-C	TX55	55	20.5	22	80
M121260T-C	TX60	55	20.5	22	80

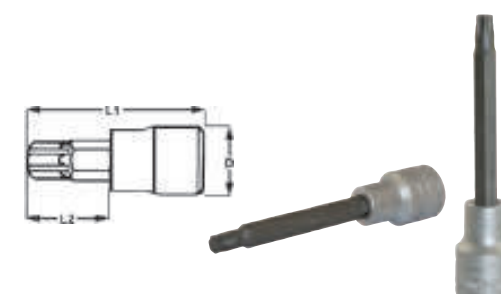

1/2"

1/2" LONG TX BIT SOCKET

- Chrome vanadium
- S2 steel bits pressed in to the socket
- Satin finish for a better grip when handling the socket
- Ball bearing recess on the female end to grip the ratchet
- Designed for use with fastenings with a TX hole
- Supplied with a metal socket clip for use with a socket rail

ITEM ID:	Size	L1 mm	L2 mm	D mm	Weight g
M122220T-C	TX20	100	65.5	22	82
M122225T-C	TX25	100	65.5	22	82
M122227T-C	TX27	100	65.5	22	82
M122230T-C	TX30	100	65.5	22	82
M122240T-C	TX40	100	65.5	22	85
M122245T-C	TX45	100	65.5	22	85
M122250T-C	TX50	100	65.5	22	100
M122255T-C	TX55	100	65.5	22	105
M122260T-C	TX60	100	65.5	22	135
M122270T-C	TX70	100	65.5	22	135

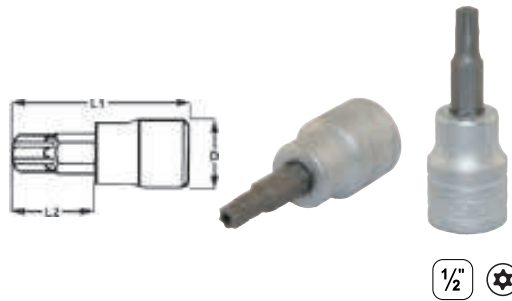

1/2" TPX BIT SOCKET

- Chrome vanadium
- S2 steel bits pressed in to the socket
- Satin finish for a better grip when handling the socket
- Ball bearing recess on the female end to grip the ratchet
- Designed for use with fastenings with a TX hole with a security pin
- Supplied with a metal socket clip for use with a socket rail

ITEM ID:	Size	L1 mm	L2 mm	D mm	Weight g
M121220-C	TPX20	55	20.5	22	64
M121225-C	TPX25	55	20.5	22	64
M121227-C	TPX27	55	20.5	22	64
M121230-C	TPX30	55	20.5	22	64
M121240-C	TPX40	55	20.5	22	64
M121245-C	TPX45	55	20.5	22	74
M121250-C	TPX50	55	20.5	22	74
M121255-C	TPX55	55	20.5	22	80
M121260-C	TPX60	55	20.5	22	80

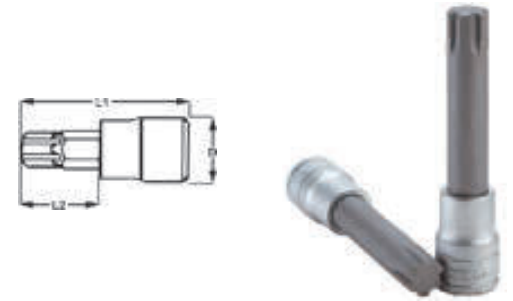

1/2" LONG RIBE BIT SOCKET

- Chrome vanadium
- S2 steel bits pressed in to the socket
- Satin finish for a better grip when handling the socket
- Ball bearing recess on the female end to grip the ratchet
- Designed for use with fastenings with a multi spline Ribe type hole
- Supplied with a metal socket clip for use with a socket rail

ITEM ID:	Size	L1 mm	L2 mm	D mm	Weight g
M122704-C	04	100	65	22	70
M122705-C	05	100	65	22	70
M122706-C	06	100	65	22	70
M122708-C	08	100	65	22	70
M122709-C	09	100	65	22	70
M122710-C	10	100	65	22	90
M122711-C	11	100	65	22	100
M122712-C	12	100	65	22	110
M122713-C	13	100	65	22	120

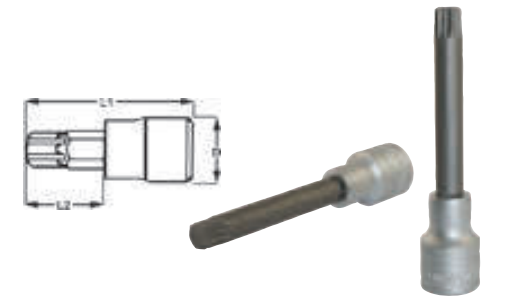

1/2" LONG XZN BIT SOCKET

- Chrome vanadium
- S2 steel bits pressed in to the socket
- Satin finish for a better grip when handling the socket
- Ball bearing recess on the female end to grip the ratchet
- Designed for use with fastenings with a multi point XZN type hole
- Supplied with a metal socket clip for use with a socket rail

ITEM ID:	Size	L1 mm	L2 mm	D mm	Weight g
M122805-C	05	100	65	22	70
M122806-C	06	100	65	22	70
M122808-C	08	100	65	22	70
M122809-C	09	100	65	22	70
M122810-C	10	100	65	22	90
M122812-C	12	100	65	22	110
M122814-C	14	100	65	22	130
M122816-C	16	100	65	22	160

3/4" DRIVE SOCKETS

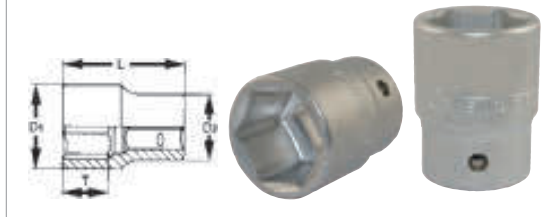

3/4" SOCKET 6 PT METRIC

- 6 point single hexagon socket for a better grip
- Chrome vanadium
- Satin finish for a better grip when handling the socket
- Ball bearing recess on the female end to grip the ratchet
- Designed and manufactured to DIN3120/3124 and ISO2725
- Supplied with a metal socket clip for use with a socket rail

ITEM ID:	Size mm	L mm	Tmin mm	D1 mm	D2 mm	Weight g
M3405196-C	19	50	14	29.2	33	180
M3405216-C	21	50	14	31.2	33	180
M3405226-C	22	50	14	32.2	36	220
M3405246-C	24	51	16	34.2	36	230
M3405266-C	26	52	18	36	36	240
M3405276-C	27	52	22	38	36	240
M3405306-C	30	54	24	42	38	260
M3405326-C	32	56	26	44	38	310
M3405336-C	33	56	26	46	38	330
M3405346-C	34	56	26	47	38	350
M3405366-C	36	58	28	50	38	430
M3405386-C	38	60	28	52	42	500
M3405416-C	41	64	30	56	45	570
M3405466-C	46	68	34	62	45	690
M3405506-C	50	72	36	68	48	830



3/4" AF

3/4" SOCKET 12 PT AF

- 12 point bi-hexagon socket for easier alignment
- Chrome vanadium
- Satin finish for a better grip when handling the socket
- Ball bearing recess on the female end to grip the ratchet
- Designed and manufactured to DIN3120/3124 and ISO2725
- Supplied with a metal socket clip for use with a socket rail

ITEM ID:	Size AF	L mm	Tmin mm	D1 mm	D2 mm	Weight g
M340124-C	3/4"	50	14	29.2	33	180
M340128-C	7/8"	51	18.1	32.2	36.2	195
M340130-C	15/16"	51	18.1	34.5	36.2	200
M340132-C	1"	51	24	37	37	200
M340134-C	1-1/16"	51	24	38.3	37	200
M340136-C	1-1/8"	51	24.3	40	38.5	230
M340138-C	1-3/16"	53	25.2	42	38.5	255
M340140-C	1-1/4"	55	28	44	38.5	275
M340142-C	1-5/16"	55	28	46	38.5	300
M340144-C	1-3/8"	57	29.7	48	42.3	360
M340146-C	1-7/16"	57	29.7	50	42.3	380
M340148-C	1-1/2"	60	31.1	52.1	45.2	440
M340152-C	1-5/8"	63	33.7	56.1	45.2	515
M340156-C	1-3/4"	65	33.7	60	48	610
M340158-C	1-13/16"	67	35.7	62	48	635
M340160-C	1-7/8"	69	37.2	64	48.3	690
M340164-C	2"	71	38.6	68.2	48.3	755

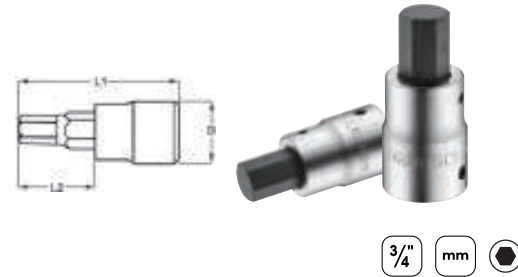

3/4" mm

3/4" HEX BIT SOCKET METRIC

- Chrome vanadium
- S2 steel bits pressed in to the socket
- Satin finish for a better grip when handling the socket
- Ball bearing recess on the female end to grip the ratchet
- Designed for use with fastenings with a hexagon hole
- Use with in-hex screws or grub screws
- Supplied with a metal socket clip for use with a socket rail

ITEM ID:	Size mm	L1 mm	L2 mm	D mm	Weight g
M341514-C	14	78.5	25	36	326
M341517-C	17	78.5	25	36	330
M341519-C	19	78.5	25	36	334
M341522-C	22	78.5	25	36	338

1" DRIVE SOCKETS



1" mm

1" SOCKET 12 PT METRIC

- 12 point bi-hexagon socket for easier alignment
- Chrome vanadium
- Satin finish for a better grip when handling the socket
- Ball bearing recess on the female end to grip the ratchet
- Designed and manufactured to DIN3120/3124 and ISO2725

ITEM ID:	Size mm	L mm	Tmin mm	D1 mm	D2 mm	Weight g
M110536	36	65.3	31.2	51	45.2	440
M110541	41	70.2	33.8	57.1	45.2	550
M110546	46	74.5	37.5	64.6	49.4	810
M110550	50	75.3	38.1	69.9	55.2	995
M110555	55	80	40	76.2	57.3	1160
M110558	58	80	40	79.2	57.3	1250
M110560	60	84	41	82.1	57.3	1410
M110565	65	87.3	46.2	88	57.3	1540
M110570	70	93.4	51.5	94	68.1	2020
M110575	75	96.1	51.5	94	68.1	2020
M110580	80	103.6	55.3	105	68.1	2500

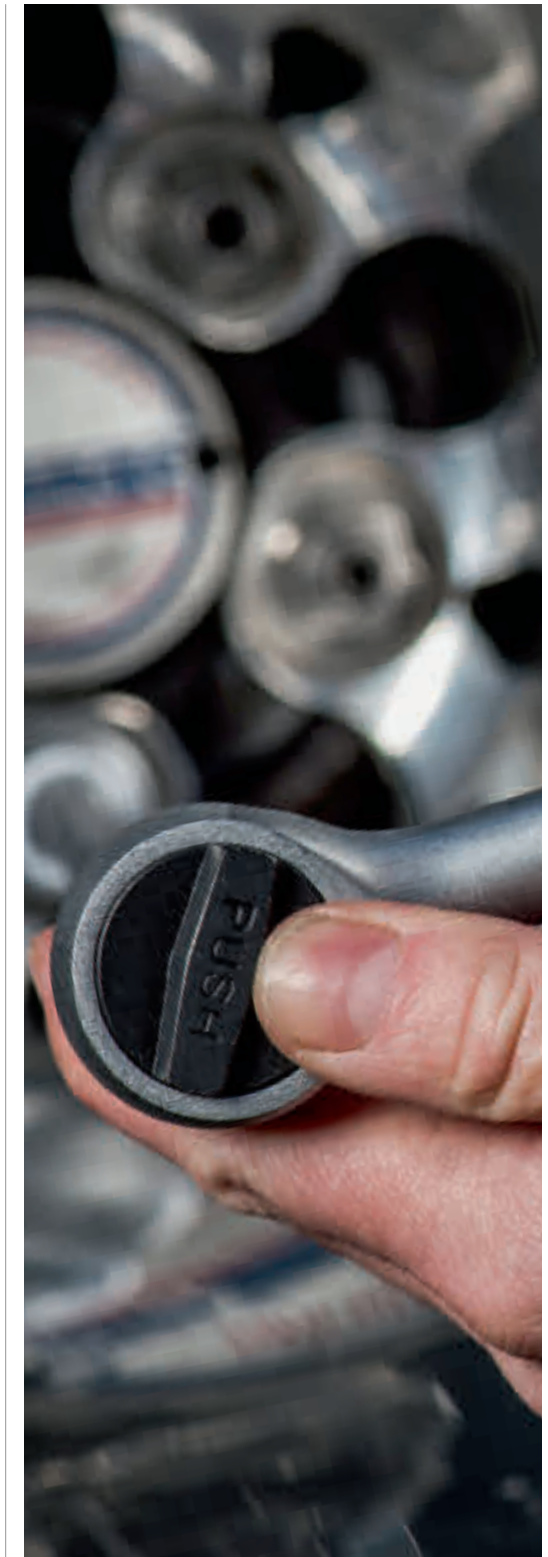

IMPACT SOCKETS

QUALITY CONSTRUCTION, MAXIMUM EFFICIENCY

Impact tools use air or electricity rather than using human strength to turn a socket. When in use they are slammed into the anvil at a high rate of speed, providing a significant mechanical advantage when trying to turn a bolt. The repeated impact, combined with the torque applied to the socket, requires a different approach in the construction of the tool.



IMPACT ACCESSORIES



ITEM ID:	Drive	Description	Standard	Retaining Ring	Retaining Pin
980020-C	3/8"	3" extension bar	DIN	O92416	P902515
980035-C	3/8"	3/8"F:1/4"M adaptor	DIN	O92416	P902515
980036-C	3/8"	3/8"F:1/2"M adaptor	DIN	O92416	P902515
980036A-C	3/8"	3/8"F:1/2"M adaptor	ANSI	-	-
980060-C	3/8"	Coupler adaptor: 1/4" hex	ANSI	-	-
980086	3/8"	3/8"M:5/16"hex	ANSI	-	-

ITEM ID:	Drive	Description	Standard	Retaining Ring	Retaining Pin
920020N	3/8"	3" extension bar	DIN	O92194	P92320
920020AN	3/8"	3" extension bar	ANSI	-	-
920021N	3/8"	5" extension bar	DIN	O92194	P92320
920021AN	3/8"	5" extension bar	ANSI	-	-
920023N	3/8"	10" extension bar	DIN	O92194	P92320
920023AN	3/8"	10" extension bar	ANSI	-	-
920030N	3/8"	universal joint	DIN	O92194	P92320
920030AN	3/8"	universal joint	ANSI	-	-
920036N	3/8"	1/2"F:3/8"M adaptor	DIN	O92194	P92320
920036AN	3/8"	1/2"F:3/8"M adaptor	ANSI	-	-
920037N	3/8"	1/2"F:3/4"M adaptor	DIN	O92194	P92320
920037AN	3/8"	1/2"F:3/4"M adaptor	ANSI	-	-
920060-C	3/8"	coupler adaptor: 5/16" hex	ANSI	-	-

ITEM ID:	Drive	Description	Standard	Retaining Ring	Retaining Pin
940022-C	3/8"	7" extension bar	DIN	O95036	P90435
940030-C	3/8"	universal joint	DIN	O93538	P90437
940037-C	3/8"	3/4"F:1/2"M adaptor	DIN	O95036	P90435
940085-C	3/8"	3/4"F:1"M adaptor	DIN	O95036	P90435

ITEM ID:	Drive	Description	Standard	Retaining Ring	Retaining Pin
910086	3/8"	1"F:3/4"M adaptor	DIN	O97045	P90545

RETAINING RINGS & PINS

ITEM ID:	Description
O92194	Retaining ring 19x4.0mm
O92244	Retaining ring 24x4.0mm
O95034	Retaining ring 34x5mm
O95036	Retaining ring 36x5mm
O97043	Retaining ring 43x7mm
O97045	Retaining ring 45x7mm
O95046	Retaining ring 46x5mm
O97051	Retaining ring 51x7mm
O910075	Retaining ring 75x10mm
O9100115	Retaining ring 115x10mm
P92320	Retaining pin 3x20mm
P92325	Retaining pin 3x25mm
P90433	Retaining pin 4x33mm
P90435	Retaining pin 4x35mm
P90445	Retaining pin 4x45mm
P90543	Retaining pin 5x43mm
P90545	Retaining pin 5x45mm
P90551	Retaining pin 5x51mm
P90675	Retaining pin 6x75mm
P906110	Retaining pin 6x110mm

3/4"

3/8"

1"



1/2"

1/4" DRIVE IMPACT SOCKETS

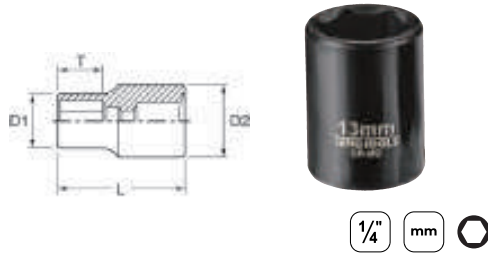

1/4" IMPACT SOCKET ANSI METRIC

- ANSI standard design with a ball bearing socket retainer
- Chrome molybdenum for use with power tools
- Black phosphate finish for easy identification as an impact socket accessory
- Designed and manufactured to DIN3129

ITEM ID:	Size mm	L mm	T mm	D1 mm	D2 mm	Weight g
960506-C	6	21.2	10	9.5	12	20
960507-C	7	21.2	11	11	12	20
960508-C	8	21.2	11	12	12	20
960510-C	10	21.2	12.5	14	12	20
960513-C	13	21.2	12	18	12	20

3/8" DRIVE IMPACT SOCKETS

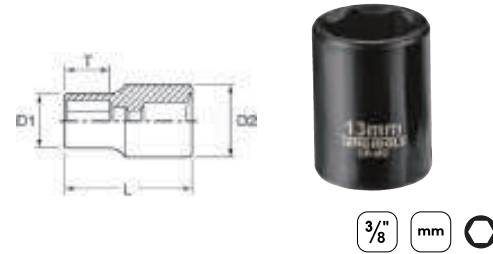

3/8" IMPACT SOCKET ANSI METRIC

- ANSI standard design with a ball bearing socket retainer
- Chrome molybdenum for use with power tools
- Black phosphate finish for easy identification as an impact socket accessory

ITEM ID:	Size mm	L mm	T mm	D1 mm	D2 mm	Weight g
980508-C	8	30	8	12.5	19	33
980510-C	10	30	8	15	19	34
980511-C	11	30	9	17	19	37
980512-C	12	30	9	19	19	40
980513-C	13	30	9	19	19	41
980514-C	14	30	9	20	20	41
980515-C	15	30	11	22	22	64
980516-C	16	30	11	24	24	64
980517-C	17	30	11	24	24	64
980519-C	19	30	11	26	26	72



3/8" DEEP IMPACT SOCKET ANSI METRIC

- ANSI standard design with a ball bearing socket retainer
- Chrome molybdenum for use with power tools
- Black phosphate finish for easy identification as an impact socket accessory

ITEM ID:	Size mm	L mm	T mm	D1 mm	D2 mm	Weight g
980608-C	8	65	12.8	12.6	19	95
980610-C	10	65	26	15.2	19	89
980611-C	11	65	27	17	19	87
980612-C	12	65	27	19	19	85
980613-C	13	65	27	19	19	80
980614-C	14	65	27	20	20	87
980616-C	16	65	27	24	24	144
980617-C	17	65	27	24	24	130
980619-C	19	65	27	26	26	143



3/8" HEX BIT IMPACT SOCKET DIN METRIC

- DIN standard design for use with a retaining pin and ring
- Chrome molybdenum for use with power tools
- Black phosphate finish for easy identification as an impact socket accessory
- Ring and pin fixing hole on the female end to secure the socket
- Designed for use with fastenings with a hexagon hole
- Use with in-hex screws or grub screws
- Supplied with a metal socket clip for use with a socket rail

ITEM ID:	Size mm	L mm	D1 mm	Weight g	Retaining Ring	Retaining Pin
981504-C	4	52	20.8	55	O935202	P90320
981505-C	5	52	20.8	57	O935202	P90320
981506-C	6	52	20.8	60	O935202	P90320
981507-C	7	52	20.8	63	O935202	P90320
981508-C	8	52	20.8	67	O935202	P90320
981510-C	10	52	20.8	74	O935202	P90320
981512-C	12	52	20.8	85	O935202	P90320



DIN Standard sockets require a retaining ring and pin to safely secure the socket to the impact tool.

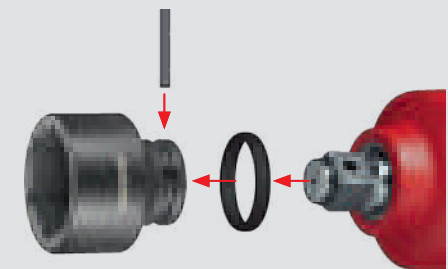

1/2" DRIVE IMPACT SOCKETS

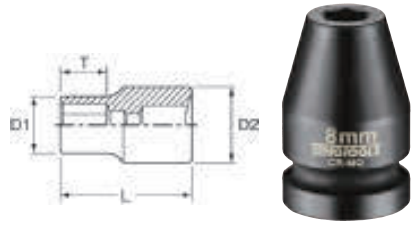

1/2" IMPACT SOCKET DIN METRIC

- DIN standard design for use with a retaining pin and ring
- Chrome molybdenum for use with power tools
- Black phosphate finish for easy identification as an impact socket accessory
- Ring and pin fixing hole on the female end to secure the socket
- Designed and manufactured to DIN3129

ITEM ID:	Size mm	L mm	T(min) mm	D1 mm	D2 mm	Retaining Ring	Retaining Pin
920508N	8	38	5	15	25	O92194	P92320
920510N	10	38	6	17	25	O92194	P92320
920511N	11	38	7	18.5	25	O92194	P92320
920512N	12	38	8	20	25	O92194	P92320
920513N	13	38	8	21	25	O92194	P92320
920514N	14	38	10	22.5	25	O92194	P92320
920515N	15	38	10	23	30	O92244	P92325
920516N	16	38	10	25	30	O92244	P92325
920517N1	17	38	10	26	30	O92244	P92325
920518N	18	38	12	27.5	30	O92244	P92325
920519N1	19	38	12	28.5	30	O92244	P92325
920520N	20	38	12	30	30	O92244	P92325
920521N1	21	38	12	31	30	O92244	P92325
920522N	22	38	14	32.5	30	O92244	P92325
920523N	23	38	16	34	30	O92244	P92325
920524N	24	38	16	35	30	O92244	P92325
920525N	25	45	18	36	30	O92244	P92325
920526N	26	45	18	37.5	30	O92244	P92325
920527N	27	45	18	38.5	30	O92244	P92325
920528N	28	47	20	40	30	O92244	P92325
920529N	29	47	20	41	30	O92244	P92325
920530N	30	50	20	42	30	O92244	P92325
920532N	32	50	22	44	30	O92244	P92325

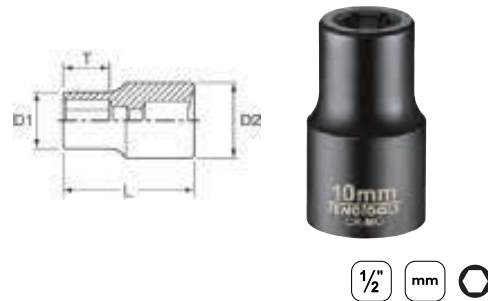

1/2" IMPACT SOCKET ANSI METRIC

- ANSI standard design with a ball bearing socket retainer
- Chrome molybdenum for use with power tools
- Black phosphate finish for easy identification as an impact socket accessory

ITEM ID:	Size mm	L mm	T(min) mm	D1 mm	D2 mm
920510AN	10	38	4.6	17	22
920511AN	11	38	5.5	17	22
920512AN	12	38	6.1	19	22
920513AN	13	38	6.8	20	24
920514AN	14	38	8.4	21	24
920515AN	15	38	8.4	23	25
920516AN	16	38	9.5	25	25
920517AN	17	38	9.5	26	26
920518AN	18	38	10.2	28	26
920519AN	19	38	11.1	28	28
920521AN	21	38	11.7	30	30
920522AN	22	38	12.5	32	32
920524AN	24	38	13.9	36	36

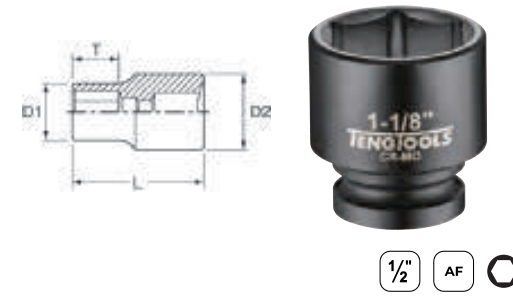

1/2" IMPACT SOCKET DIN AF

- DIN standard design for use with a retaining pin and ring
- Chrome molybdenum for use with power tools
- Black phosphate finish for easy identification as an impact socket accessory
- Ring and pin fixing hole on the female end to secure the socket
- Supplied with a metal socket clip for use with a socket rail

ITEM ID:	Size AF	L mm	T(min) mm	D1 mm	D2 mm	Retaining Ring	Retaining Pin
920112	3/8"	38	3.9	16.1	24	O92194	P92320
920114	7/16"	38	5.5	17.8	24	O92194	P92320
920116	1/2"	38	6.7	19.9	24	O92194	P92320
920118	9/16"	38	8.3	21.9	24	O92194	P92320
920120	5/8"	38	9.5	24	24	O92194	P92320
920122	11/16"	38	9.5	26	26	O92244	P92325
920124	3/4"	38	11.1	28	28	O92244	P92325
920126	13/16"	38	11.5	30	30	O92244	P92325
920128	7/8"	38	12.7	32	30	O92244	P92325
920130	15/16"	38	12.7	33.9	30	O92244	P92325
920132	1"	40	13.8	35.6	30	O92244	P92325
920134	1-1/16"	42	15.8	37.6	30	O92244	P92325
920136	1-1/8"	42	16.6	39.8	30	O92244	P92325
920140	1-1/4"	44	16.6	44	30	O92244	P92325

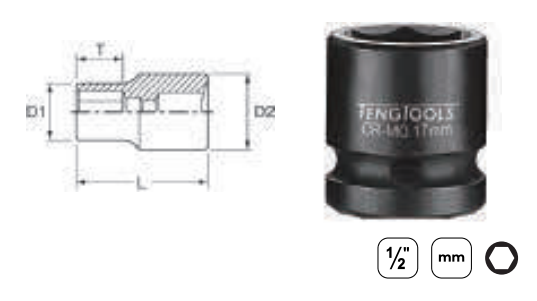

1/2" STUBBY IMPACT SOCKET DIN METRIC

- Short reach for use in confined spaces
- DIN standard design for use with a retaining pin and ring
- Chrome molybdenum for use with power tools
- Black phosphate finish for easy identification as an impact socket accessory
- Ring and pin fixing hole on the female end to secure the socket
- Designed and manufactured to DIN3129

ITEM ID:	Size mm	L mm	T(min) mm	D1 mm	D2 mm	Retaining Ring	Retaining Pin
920710-C	10	28	5	18	24	O92194	P92320
920712-C	12	28	5	20	24	O92194	P92320
920713-C	13	28	5	20	24	O92194	P92320
920714-C	14	28	5	22	24	O92194	P92320
920715-C	15	28	5	24	24	O92194	P92320
920716-C	16	28	5	24	24	O92194	P92320
920717-C	17	28	10	26	26	O92244	P92325
920718-C	18	28	10	28	28	O92244	P92325
920719-C	19	28	10	28	28	O92244	P92325
920721-C	21	28	10	30	30	O92244	P92325
920722-C	22	28	10	32	30	O92244	P92325
920724-C	24	28	10	34	30	O92244	P92325



1/2" mm

1/2" DEEP IMPACT SOCKET DIN METRIC

- DIN standard design for use with a retaining pin and ring
- Chrome molybdenum for use with power tools
- Black phosphate finish for easy identification as an impact socket accessory
- Ring and pin fixing hole on the female end to secure the socket
- Designed and manufactured to DIN3129

ITEM ID:	Size mm	L mm	T(min) mm	D1 mm	D2 mm	Retaining Ring	Retaining Pin
920610N	10	80	9	17	25	O92194	P92320
920611N	11	80	10.5	18.5	25	O92194	P92320
920612N	12	80	12	20	25	O92194	P92320
920613N	13	80	12	21	25	O92194	P92320
920614N	14	80	15	22.5	25	O92194	P92320
920615N	15	80	15	23	30	O92244	P92325
920616N	16	80	15	25	30	O92244	P92325
920617N	17	80	15	26	30	O92244	P92325
920618N	18	80	18	27.5	30	O92244	P92325
920619N	19	80	18	28.5	30	O92244	P92325
920620N	20	80	18	30	30	O92244	P92325
920621N	21	80	18	31	30	O92244	P92325
920622N	22	80	21	32.5	30	O92244	P92325
920623N	23	80	24	34	30	O92244	P92325
920624N	24	80	24	35	30	O92244	P92325
920627N	27	80	27	38.5	30	O92244	P92325
920628N	28	80	30	40	30	O92244	P92325
920629N	29	80	30	40	30	O92244	P92325
920630N	30	80	30	42	30	O92244	P92325
920632N	32	80	33	44	30	O92244	P92325
920635N	35	80	33	48	30	O92244	P92325
920636N	36	80	33	50	30	O92244	P92325



1/2" mm

1/2" DEEP IMPACT SOCKET ANSI METRIC

- ANSI standard design with a ball bearing socket retainer
- Chrome molybdenum for use with power tools
- Black phosphate finish for easy identification as an impact socket accessory

ITEM ID:	Size mm	L mm	T(min) mm	D1 mm	D2 mm
920610AN	10	78	4.6	17	22
920611AN	11	78	5.5	18	22
920612AN	12	78	6.1	19	22
920613AN	13	78	6.8	22	24
920614AN	14	78	8.4	22	24
920615AN	15	78	8.4	24	24
920616AN	16	78	9.5	24	24
920617AN	17	78	9.5	26	26
920618AN	18	78	10.2	28	28
920619AN	19	78	11.1	28	28
920621AN	21	78	11.7	30	30
920622AN	22	78	12.5	32	32
920624AN	24	78	13.9	35.8	35.8



1/2" AF

1/2" DEEP IMPACT SOCKET DIN AF

- DIN standard design for use with a retaining pin and ring
- Chrome molybdenum for use with power tools
- Black phosphate finish for easy identification as an impact socket accessory
- Ring and pin fixing hole on the female end to secure the socket
- Supplied with a metal socket clip for use with a socket rail

ITEM ID:	Size AF	L mm	T(min) mm	D1 mm	D2 mm	Retaining Ring	Retaining Pin
920212	3/8"	78	3.9	16	24	O92194	P92320
920214	7/16"	78	5.5	18	24	O92194	P92320
920216	1/2"	78	6.7	20.4	24	O92194	P92320
920218	9/16"	78	8.3	22	24	O92194	P92320
920220	5/8"	78	9.5	24	24	O92194	P92320
920222	11/16"	78	9.5	26	26	O92244	P92325
920224	3/4"	78	11.1	28	28	O92244	P92325
920226	13/16"	78	11.5	30	30	O92244	P92325
920228	7/8"	78	12.7	32	30	O92244	P92325
920230	15/16"	78	12.7	34	30	O92244	P92325
920232	1"	78	13.8	36	30	O92244	P92325
920234	1-1/16"	78	15.8	38	30	O92244	P92325
920236	1-1/8"	78	16.6	40	30	O92244	P92325
920240	1-1/4"	78	16.6	44.4	30	O92244	P92325
920242	1-5/16"	80	16.6	46	30	O92244	P92325
920248	1-1/2"	80	16.6	52	30	O92244	P92325



1/2" mm

1/2" HEX IMPACT SOCKET DIN METRIC

- DIN standard design for use with a retaining pin and ring
- Chrome molybdenum for use with power tools
- Black phosphate finish for easy identification as an impact socket accessory
- Ring and pin fixing hole on the female end to secure the socket
- Designed for use with fastenings with a hexagon hole
- Use with in-hex screws or grub screws
- Supplied with a metal socket clip for use with a socket rail

ITEM ID:	Size mm	L mm	D1 mm	Weight g	Retaining Ring	Retaining Pin
921505-C	5	78	25	81	O92194	P92320
921506-C	6	78	25	86	O92194	P92320
921508-C	8	78	25	100	O92194	P92320
921510-C	10	78	25	114	O92194	P92320
921512-C	12	78	25	132	O92194	P92320
921514-C	14	78	25	155	O92194	P92320
921517-C	17	78	25	191	O92194	P92320
921519-C	19	78	25	216	O92194	P92320

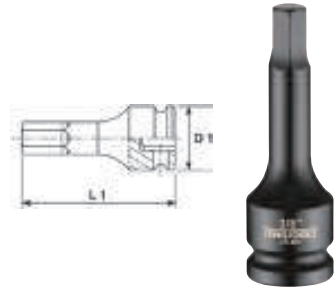

1/2" mm

1/2" HEX IMPACT SOCKET DIN AF

- DIN standard design for use with a retaining pin and ring
- Chrome molybdenum for use with power tools
- Black phosphate finish for easy identification as an impact socket accessory
- Ring and pin fixing hole on the female end to secure the socket
- Designed for use with fastenings with a hexagon hole
- Use with in-hex screws or grub screws
- Supplied with a metal socket clip for use with a socket rail

ITEM ID:	Size mm	L mm	D1 mm	Retaining Ring	Retaining Pin
921606	3/16"	78	24.8	O92194	P92320
921608	1/4"	78	24.8	O92194	P92320
921610	5/16"	78	24.8	O92194	P92320
921612	3/8"	78	24.8	O92194	P92320
921614	7/16"	78	24.8	O92194	P92320
921616	1/2"	78	24.8	O92194	P92320
921618	9/16"	78	24.8	O92194	P92320
921620	5/8"	78	24.8	O92194	P92320
921622	11/16"	78	24.8	O92194	P92320
921624	3/4"	78	24.8	O92194	P92320



1/2"

1/2" TX IMPACT SOCKET DIN

- DIN standard design for use with a retaining pin and ring
- Chrome molybdenum for use with power tools
- Black phosphate finish for easy identification as an impact socket accessory
- Ring and pin fixing hole on the female end to secure the socket
- Designed for use with fastenings with a TX hole
- Supplied with a metal socket clip for use with a socket rail

ITEM ID:	Size	L mm	D1 mm	D2 mm	Weight g	Retaining Ring	Retaining Pin
921210TX-C	TX10	78	25	6.5	73	O92194	P92320
921215TX-C	TX15	78	25	6.5	74	O92194	P92320
921220TX-C	TX20	78	25	6.5	74	O92194	P92320
921225TX-C	TX25	78	25	6.5	74	O92194	P92320
921227TX-C	TX27	78	25	6.5	78	O92194	P92320
921230TX-C	TX30	78	25	6.5	79	O92194	P92320
921240TX-C	TX40	78	25	8	86	O92194	P92320
921245TX-C	TX45	78	25	9	93	O92194	P92320
921250TX-C	TX50	78	25	10	98	O92194	P92320
921255TX-C	TX55	78	25	12	109	O92194	P92320
921260TX-C	TX60	78	25	14	122	O92194	P92320
921270TX-C	TX70	78	25	16	148	O92194	P92320



1/2"

1/2" XZN IMPACT SOCKET

- DIN standard design for use with a retaining pin and ring
- Chrome molybdenum for use with power tools
- Black phosphate finish for easy identification as an impact socket accessory
- Ring and pin fixing hole on the female end to secure the socket
- Designed for use with fastenings with a multi point XZN type hole
- Supplied with a metal socket clip for use with a socket rail

ITEM ID:	Size	L mm	L2 mm	D mm	Weight g
921814	14	43	23	25	73
921816	16	43	23	25	77
921817	17	43	23	25	90
921818	18	43	23	25	90
923814	14	78	53	25	127
923816	16	78	53	25	134
923817	17	78	53	25	150
923818	18	78	53	25	151



1/2"

1/2" TORQUE STICK

- Designed for tightening wheel nuts to a pre-set torque using an air gun
- The bar absorbs the excess power of the gun once the torque is reached
- Ensures uniform tightening of the wheel nuts
- Supplied with a metal socket clip for use with a socket rail

ITEM ID:	Drive	Torque Nm	Length mm	Retaining Ring	Retaining Pin
923090	1/2"	90	200	O92194	P92320
923110	1/2"	110	200	O92194	P92320
923120	1/2"	120	200	O92194	P92320
923140	1/2"	140	200	O92194	P92320

3/4" DRIVE IMPACT SOCKETS



3/4" mm

3/4" IMPACT SOCKET DIN METRIC

- DIN standard design for use with a retaining pin and ring
- Chrome molybdenum for use with power tools
- Black phosphate finish for easy identification as an impact socket accessory
- Ring and pin fixing hole on the female end to secure the socket

ITEM ID:	Size mm	L mm	T(min) mm	D1 mm	D2 mm	Retaining Ring	Retaining Pin
940519-C	19	50	13	33	44	O95036	P90435
940521-C	21	50	15	35	44	O95036	P90435
940522-C	22	50	15	37	44	O95036	P90435
940523-C	23	50	16	38	44	O95036	P90435
940524-C	24	50	16	39	44	O95036	P90435
940527-C	27	54	19	43	44	O95036	P90435
940528-C	28	54	19	44	44	O95036	P90435
940530-C	30	54	21	47	44	O95036	P90435
940532-C	32	56	22	48	44	O95036	P90435
940533-C	33	56	22	51	44	O95036	P90435
940534-C	34	56	22	52	44	O95036	P90435
940536-C	36	56	25	54	44	O95036	P90435
940538-C	38	58	25	57	44	O95036	P90435
940540-C	40	58	25	58	44	O95036	P90435
940541-C	41	58	27	60	44	O95036	P90435
940546-C	46	63	30	67	44	O95036	P90435
940550-C	50	68	30	71	44	O95036	P90435

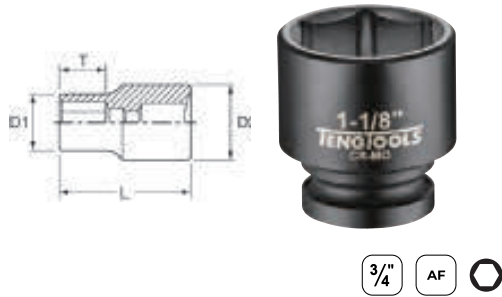

3/4" IMPACT SOCKET DIN AF

- DIN standard design for use with a retaining pin and ring
- Chrome molybdenum for use with power tools
- Black phosphate finish for easy identification as an impact socket accessory
- Ring and pin fixing hole on the female end to secure the socket to the air gun
- Supplied with a metal socket clip for use with a socket rail

ITEM ID:	Size AF	L mm	T(min) mm	D1 mm	D2 mm	Retaining Ring	Retaining Pin
940122	11/16"	51	14	29.5	41.4	O95036	P90435
940124	3/4"	51	14	32	41.4	O95036	P90435
940126	13/16"	51	14	35	41.4	O95036	P90435
940128	7/8"	51	14	36	41.4	O95036	P90435
940130	15/16"	51	16.5	38.5	41.4	O95036	P90435
940132	1"	53	16.5	40	41.4	O95036	P90435
940134	1-1/16"	53	20	42.5	44	O95036	P90435
940136	1-1/8"	53	20	44	44	O95036	P90435
940138	1-3/16"	53	20	46	44	O95036	P90435
940140	1-1/4"	57	21	48.5	44	O95036	P90435
940142	1-5/16"	57	21	50	44	O95036	P90435
940144	1-3/8"	57	21	52.5	44	O95036	P90435
940146	1-7/16"	57	21	53.5	44	O95036	P90435
940148	1-1/2"	57	22	56	44	O95036	P90435
940150	1-9/16"	58	22	58.5	44	O95036	P90435
940152	1-5/8"	58	22	60	44	O95036	P90435
940154	1-11/16"	62	25	63.5	44	O95036	P90435
940156	1-3/4"	62	25	64.5	44	O95036	P90435
940160	1-7/8"	68	30	68	44	O95036	P90435
940162	1-15/16"	68	30	70	44	O95036	P90435
940164	2"	68	30	71	44	O95036	P90435
940166	2-1/16"	71	32	73	54	O95046	P90445
940168	2-1/8"	71	32	75.5	54	O95046	P90445
940170	2-3/16"	71	32	77.5	54	O95046	P90445
940172	2-1/4"	73	34	80	54	O95046	P90445
940174	2-5/16"	73	34	81	54	O95046	P90445
940176	2-3/8"	73	34	83	54	O95046	P90445



3/4" DEEP IMPACT SOCKET DIN METRIC

- DIN standard design for use with a retaining pin and ring
- Chrome molybdenum for use with power tools
- Black phosphate finish for easy identification as an impact socket accessory
- Ring and pin fixing hole on the female end to secure the socket to the air gun

ITEM ID:	Size mm	L mm	T(min) mm	D1 mm	D2 mm	Retaining Ring	Retaining Pin
940619-C	19	95	31	33	44	O95036	P90435
940621-C	21	95	31	35	44	O95036	P90435
940622-C	22	95	31	37	44	O95036	P90435
940623-C	23	95	31	38	44	O95036	P90435
940624-C	24	95	31	39	44	O95036	P90435
940627-C	27	95	31	43	44	O95036	P90435
940630-C	30	95	33	47	44	O95036	P90435
940632-C	32	95	33	49	44	O95036	P90435
940633-C	33	95	34	51	44	O95036	P90435
940634-C	34	95	34	52	44	O95036	P90435
940636-C	36	95	36	54	44	O95036	P90435
940638-C	38	95	36	57	44	O95036	P90435
940641-C	41	95	36	58	44	O95036	P90435
940646-C	46	95	36	67	44	O95036	P90435
940650-C	50	95	36	71	44	O95036	P90435



3/4" DEEP IMPACT SOCKET DIN AF

- DIN standard design for use with a retaining pin and ring
- Chrome molybdenum for use with power tools
- Black phosphate finish for easy identification as an impact socket accessory
- Ring and pin fixing hole on the female end to secure the socket
- Supplied with a metal socket clip for use with a socket rail

ITEM ID:	Size AF	L mm	T(min) mm	D1 mm	D2 mm	Retaining Ring	Retaining Pin
940224	3/4"	90	26	32	41.4	O95034	P90433
940226	13/16"	90	26	35	41.4	O95034	P90433
940228	7/8"	90	26	36	41.4	O95034	P90433
940230	15/16"	90	26	38.5	41.4	O95034	P90433
940232	1"	90	26	40	41.4	O95034	P90433
940234	1-1/16"	90	28	42.5	44	O95036	P90435
940236	1-1/8"	90	28	44	44	O95036	P90435
940238	1-3/16"	90	28	46	44	O95036	P90435
940240	1-1/4"	90	28	48.5	44	O95036	P90435
940242	1-5/16"	90	30	50	44	O95036	P90435
940244	1-3/8"	90	30	52.5	44	O95036	P90435
940246	1-7/16"	90	30	53.5	44	O95036	P90435
940248	1-1/2"	90	34	56	44	O95036	P90435
940250	1-9/16"	90	34	58.5	44	O95036	P90435
940252	1-5/8"	90	34	60	44	O95036	P90435
940254	1-11/16"	90	34	63.5	44	O95036	P90435
940256	1-3/4"	90	34	64.5	44	O95036	P90435
940258	1-13/16"	90	34	66	44	O95036	P90435
940260	1-7/8"	90	34	68	44	O95036	P90435

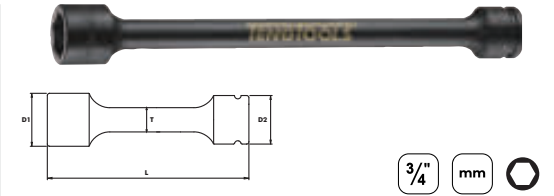

3/4" EXTRA LONG IMPACT SOCKET METRIC

- Ideal for reaching wheel nuts on recessed truck wheels
- DIN standard design for use with a retaining pin and ring
- Chrome molybdenum for use with power tools
- Black phosphate finish for easy identification as an impact socket accessory
- Ring and pin fixing hole on the female end to secure the socket

ITEM ID:	Size mm	L mm	T(min) mm	D1 mm	D2 mm	Retaining Ring	Retaining Pin
940732-C	32	400	22	48	44	O95036	P90435



3/4" HEX IMPACT SOCKET DIN METRIC

- DIN standard design for use with a retaining pin and ring
- Chrome molybdenum for use with power tools
- Black phosphate finish for easy identification as an impact socket accessory
- Ring and pin fixing hole on the female end to secure the socket
- Designed for use with fastenings with a hexagon hole
- Use with in-hex screws or grub screws
- Supplied with a metal socket clip for use with a socket rail

ITEM ID:	Size mm	L mm	D1 mm	Weight g	Retaining Ring	Retaining Pin
941519-C	19	90	44	600	O95036	P90435
941522-C	22	90	44	600	O95036	P90435
941524-C	24	90	44	600	O95036	P90435

1" DRIVE IMPACT SOCKETS



1" IMPACT SOCKET DIN METRIC

- DIN standard design for use with a retaining pin and ring
- Chrome molybdenum for use with power tools
- Black phosphate finish for easy identification as an impact socket accessory
- Ring and pin fixing hole on the female end to secure the socket

ITEM ID:	Size mm	L mm	T(min) mm	D1 mm	D2 mm	Retaining Ring	Retaining Pin
910524	24	58	18	41	54	O97045	P90545
910527	27	58	20	46	54	O97045	P90545
910530	30	60	21	49	54	O97045	P90545
910532	32	60	21	52	54	O97045	P90545
910533	33	60	21	53	54	O97045	P90545
910534	34	60	21	55	54	O97045	P90545
910536	36	65	30	56	54	O97045	P90545
910538	38	65	30	59	54	O97045	P90545
910541	41	67	30	63	54	O97045	P90545
910546	46	74	40	69	54	O97045	P90545
910550	50	80	43	74	54	O97045	P90545
910555	55	84	43	80	54	O97045	P90545
910560	60	87	46	86	54	O97045	P90545
910565	65	90	49	92	54	O97045	P90545
910570	70	96	51	99	54	O97045	P90545
910575	75	98	52	104	54	O97051	P90551
910580	80	100	52	109	86	O97051	P90551
910585	85	100	52	115	86	O910075	P90675
910590	90	100	55	119	86	O910075	P90675
910595	95	100	55	130	86	O910075	P90675

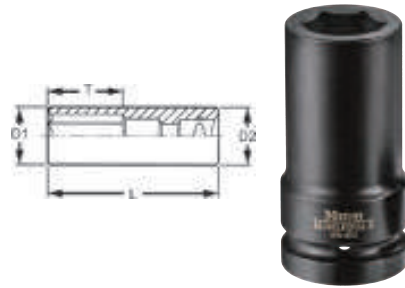

1" DEEP IMPACT SOCKET DIN METRIC

- DIN standard design for use with a retaining pin and ring
- Chrome molybdenum for use with power tools
- Black phosphate finish for easy identification as an impact socket accessory
- Ring and pin fixing hole on the female end to secure the socket

ITEM ID:	Size mm	L mm	T(min) mm	D1 mm	D2 mm	Retaining Ring	Retaining Pin
910627R	27	100	50	46	54	O97045	P90545
910630R	30	100	50	50	54	O97045	P90545
910632R	32	100	50	52	54	O97045	P90545
910633R	33	100	50	53	54	O97045	P90545

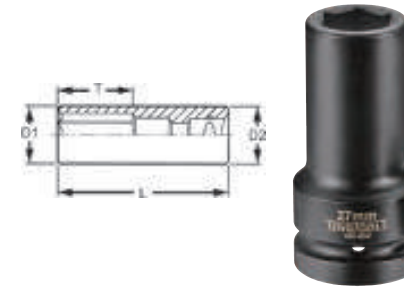

1" DEEP THINWALL IMPACT SOCKET DIN METRIC

- Thin wall design for reaching in to recesses
- DIN standard design for use with a retaining pin and ring
- Chrome molybdenum for use with power tools
- Black phosphate finish for easy identification as an impact socket accessory
- Ring and pin fixing hole on the female end to secure the socket

ITEM ID:	Size mm	L mm	T(min) mm	D1 mm	D2 mm	Retaining Ring	Retaining Pin
910624	24	100	28	38	54	O97045	P90545
910627	27	100	28	43	54	O97045	P90545
910628	28	100	28	43	54	O97045	P90545
910630	30	100	42	45	54	O97045	P90545
910632	32	100	45	47	54	O97045	P90545
910633	33	100	45	49	54	O97045	P90545
910636	36	100	66	52	54	O97045	P90545

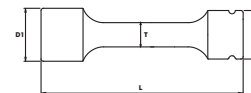

1" EXTRA LONG IMPACT SOCKET METRIC

- Ideal for reaching wheel nuts on recessed truck wheels
- DIN standard design for use with a retaining pin and ring
- Chrome molybdenum for use with power tools
- Black phosphate finish for easy identification as an impact socket accessory
- Ring and pin fixing hole on the female end to secure the socket

ITEM ID:	Size mm	L mm	T(min) mm	D1 mm	D2 mm	Retaining Ring	Retaining Pin
910732	32	400	28	48	54	O97045	P90545

1-1/2" DRIVE IMPACT SOCKETS

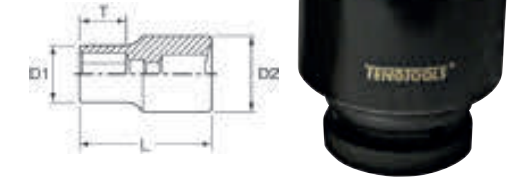

1-1/2" IMPACT SOCKET DIN METRIC

- DIN standard design for use with a retaining pin and ring
- Chrome molybdenum for use with power tools
- Black phosphate finish for easy identification as an impact socket accessory
- Ring and pin fixing hole on the female end to secure the socket

ITEM ID:	Size mm	L mm	T(min) mm	D1 mm	D2 mm	Retaining Ring	Retaining Pin
912041	41	80	27	69	86	O910075	P90675
912046	46	84	29	75	86	O910075	P90675
912050	50	87	30	80	86	O910075	P90675
912055	55	90	32	86	86	O910075	P90675
912060	60	95	35	91	86	O910075	P90675
912065	65	100	38	100	86	O910075	P90675
912070	70	105	40	104	86	O910075	P90675
912075	75	105	42	105	86	O910075	P90675
912080	80	110	46	116	86	O910075	P90675
912085	85	110	46	123	86	O910075	P90675
912090	90	112	48	129	86	O910075	P90675
912095	95	112	48	136	127	O9100115	P906110
912100	100	115	50	142	127	O9100115	P906110
912105	105	120	52	148	127	O9100115	P906110
912110	110	124	54	154	127	O9100115	P906110
912115	115	128	56	161	127	O9100115	P906110
912120	120	132	58	167	127	O9100115	P906110
912125	125	136	60	173	127	O9100115	P906110
912130	130	140	60	180	127	O9100115	P906110

TORQUE TOOLS

MAKE THE PROFESSIONAL CHOICE

TengTools torque wrenches have become an industry standard. Whether you choose the classic version that has been a favourite for many years or the new P-Series range designed for the industrial and maintenance sectors you are guaranteed quality, accuracy and reliability as standard.



TORQUE WRENCH

Click type mechanism to signal when the required torque is reached

Reversible 24 teeth ratchet mechanism in according to DIN3122 giving 15° increments

Equipped with an in-built angular gauge for when tightening at specific angle is required

Switch for changing between left and right-hand action. Designed to torque right hand only. Bi-Directional models are available.

Scale in Nm & ft/lb

Twist locking to ensure the set torque is maintained

Accurate to +/- 4% and conforms to ISO6789



TORQUE WRENCH PLUS

Quick release 72 teeth ratchet mechanism with twist reverse manufactured to DIN3122

Compact head for easier use in confined spaces

Click type mechanism to signal when the required torque is reached

Industrial quality grade steel tube for added stability

Ergonomic bi-material grip for maximum comfort when in use

Easy to read Nm scale that is simple to adjust

Locking button to ensure the set torque is securely maintained

Hanging facility which can be used together with a fall protection equipment

Accurate to +/- 4% and conforms to ISO6789



1/4" DRIVE



1/4"

1/4" TORQUE SCREWDRIVER

- Slipper mechanism ensures that no torque is applied beyond the set torque
- Simple to adjust and easy to read Nm scale
- Push locking facility to ensure the set torque is maintained
- Accurate to +/- 6% and conforms to ISO6789 for assured accuracy
- Each torque wrench has it's own individual certification number
- Supplied in a handy storage case

ITEM ID:	Range Nm
1492TSD	1-5



TT SERIES

1

38 Pieces

1/4"

TORQUE SCREWDRIVER SET TTI 38 PIECES

- Includes a 1-5Nm 1/4" drive torque screwdriver
- Accurate to +/- 6% and conforms to ISO6789 for assured accuracy
- Wide range of screwdriver bits and accessories
- Removable lid and dove tail joints

1-5Nm Torque screwdriver, 1/4"M x 1/4"Hex adaptor	
1/4" Hex bits:	3, 4.5, 5.5, 6.5 PH0, PH1, PH2, PH3 PH2G (x2)
Length 25mm	2, 3, 4, 5, 6 PZ0, PZ1, PZ2, PZ3 ROB1, 2, 3
	TX8, TX9, TX10, TX15, TX20, TX25, TX27, TX30, TX40
	TPX10, TPX15, TPX20, TPX30, TPX40 PH2G (x2)

Item ID: TTSD38



FOAM SERIES

1

38 Pieces

1/4"

TORQUE SCREWDRIVER SET FOAM1

- 1-5 Nm torque screwdriver with accessories
- Accurate to +/- 6% and conforms to ISO6789 for assured accuracy
- Supplied in the unique TengTools FOAM1 tray
- Tools are held in place using three colour pre-cut EVA foam clearly showing where each tool belongs

1-5Nm Torque screwdriver, 1/4"M x 1/4"Hex adaptor	
1/4" Hex bits:	3, 4.5, 5.5, 6.5 PH0, PH1, PH2, PH3 PH2G (x2)
Length 25mm	2, 3, 4, 5, 6 PZ0, PZ1, PZ2, PZ3 ROB1, 2, 3
	TX8, TX9, TX10, TX15, TX20, TX25, TX27, TX30, TX40
	TPX10, TPX15, TPX20, TPX30, TPX40

Item ID: TEASD38



FOAM SERIES

2

95 Pieces

1/4"

TORQUE SCREWDRIVER SET FOAM2

- 1-5 Nm torque screwdriver with accessories
- Accurate to +/- 6% and conforms to ISO6789 for assured accuracy
- Ratcheting bits driver set included
- Supplied in the unique TengTools FOAM2 tray
- Tools are held in place using three colour pre-cut EVA foam clearly showing where each tool belongs

1/4" Drive	1-5 Nm Torque screwdriver, Quick release chuck, Sliding T-bar, 6" Flexible extension, Ratcheting bits driver with assorted bits, 1/4"M:1/4" hex adaptor
3/8" Drive	3/8"M x 5/16" Hex adaptor
1/2" Drive	Reversible impact driver, 5/16" Hex bit adaptor
5/16" Hex bits:	TX30, TX40, TX45, TX50, TX55 6, 8, 10, 12
Length 36mm	PH1, PH2, PH3, PH4 4, 5, 6, 8
1/4" Hex bits:	3.5, 4, 4.5, 5.5 (x2), 6.5, 8 1, 2, 3
Length 25mm	PZ1 (x3), PZ2 (x6), PZ3 2, 3, 4, 5, 6, 8
	PH1 (x3), PH2 (x6), PH3 PH2G (x3)
	TX6, TX7, TX8, TX9, TX10, TX15, TX20 (x3), TX25 (x3), TX27, TX30, TX40
	TPX10, TPX15, TPX20 (x2), TPX25 (x2), TPX27, TPX30, TPX40

Item ID: TEDSD14



1/4"

1/4" TORQUE WRENCH

- Equipped with an in-built angular gauge for easier after tightening
- Click type mechanism to signal when the required torque is reached
- Additional ft/lb reference scale
- Marked to show the correct place where pressure should be applied
- Twist locking facility to ensure the set torque is maintained
- Reversible 24 teeth ratchet mechanism (DIN3122) giving 15° increments
- Designed to torque right hand (clockwise) fasteners
- Accurate to +/- 4% and conforms to ISO6789 for assured accuracy
- Each torque wrench has it's own individual certification number
- Supplied in a handy storage case

ITEM ID:	Updated Cert	Range Nm	ft/lb	Scale Nm	ft/lb	L mm	W mm	H mm	Weight g
1492AG-E	-	5-25	4-18	0.4	0.4	277	27.6	20.6	580
1492AG-CT	Y	5-25	4-18	0.4	0.4	277	27.6	20.6	580

3/8" DRIVE



3/8"

3/8" TORQUE WRENCH

- Equipped with an in-built angular gauge for easier after tightening
- Click type mechanism to signal when the required torque is reached
- Additional ft/lb reference scale
- Marked to show the correct place where pressure should be applied
- Twist locking facility to ensure the set torque is maintained
- Reversible 24 teeth ratchet mechanism (DIN3122) giving 15° increments
- Designed to torque right hand (clockwise) fasteners
- Accurate to +/- 4% and conforms to ISO6789 for assured accuracy
- Each torque wrench has it's own individual certification number
- Supplied in a handy storage case

ITEM ID:	Updated Cert	Range Nm	ft/lb	Scale Nm	ft/lb	L mm	W mm	H mm	Weight g
3892AG-E1	-	5-25	4-18	0.4	0.4	277	27.6	20.6	580
3892AG1-CT	Y	5-25	4-18	0.4	0.4	277	27.6	20.6	580
3892AG-E3	-	20-110	15-81	1.0	1.0	368	35.9	27.7	580
3892AG3-CT	Y	20-110	15-81	1.0	1.0	368	35.9	27.7	580



3/8"

3/8" TORQUE WRENCH PLUS

- Click type mechanism to signal when the required torque is reached
- Simple to adjust and easy to read Nm scale
- Locking button to ensure the set torque is securely maintained
- Compact head for easier use in confined spaces
- Quick release 72 teeth ratchet mechanism with twist reverse (DIN3122)
- Designed to torque right hand (clockwise) fasteners
- Ergonomic bi-material grip for added comfort
- Marked to show the correct place where pressure should be applied
- Hanging facility which can be used together with a fall protection wire
- Accurate to +/- 4% and conforms to ISO6789 for assured accuracy
- Each torque wrench has it's own individual certification number
- Supplied in a handy storage case

ITEM ID:	Updated Cert	Range Nm	Scale Nm	L mm	W mm	H mm	Weight g
3892P060	-	12-60	0.5	380	36	36	930
3892P060-CT	Y	12-60	0.5	380	36	36	930
3892P100	-	20-100	0.5	410	36	36	960
3892P100-CT	Y	20-100	0.5	410	36	36	960



3/8"

3/8" DIGITAL BI-DIRECTIONAL TORQUE WRENCH

- Simple to use with 9 separate torque settings
- Can be pre-programmed for different torque tolerances before use
- Audio visual warning with an indicator light to ensure the correct torque
- Easy to read digital scale showing Nm, ft/lb, in/lb or kg/m readings
- Marked to show the correct place where pressure should be applied
- Reversible 45 teeth quick release ratchet mechanism (DIN3122)
- Suitable for use on clockwise and anti-clockwise fastenings
- Accurate to +/- 1% and conforms to ISO6789 for assured accuracy
- Each torque wrench has it's own individual certification number
- Uses standard AA batteries for easy replacement
- Supplied in a handy storage case

ITEM ID:	Updated Cert	Range Nm	Scale Nm	L mm	W mm	H mm	Weight g		
3892D100	-	10-100	7-75	0.1	0.1	457	42.5	46.5	904
3892D100-CT	Y	10-100	7-75	0.1	0.1	457	42.5	46.5	904



TT SERIES
x4

22 Pieces

3/8"

3/8" TORQUE WRENCH SET 20-110 NM TTX4

- Ideal set for automotive technicians
- Equipped with an in-built angular gauge for easier after tightening
- Click type mechanism when the required torque is reached
- Additional ft/lb reference scale (range 15-81 ft/lb)
- Marked to show the correct place where pressure should be applied
- Twist locking facility to ensure the set torque is maintained
- Reversible 24 teeth ratchet (DIN3122) giving 15° increments
- Designed to torque right hand (clockwise) fasteners
- Accurate to +/- 4% conforms to ISO6789 for assured accuracy
- Individually tested and certified at the time of manufacture

3/8" Drive Torque wrench (20-110Nm, 15-81 ft/lb), 3" and 5" extension bars, adaptor for 10mm hex bits

10mm Hex Drive TX bits:

TX8, TX10, TX15, TX20, TX25, TX27, TX30, TX40

3/8" Drive Crow Foot Wrenches

10, 11, 12, 13, 14, 15, 16, 17, 18, 19 mm

Item ID: **TTX3892**



FOAM SERIES
x4

2 Pieces

3/8"

1/2"

3/8" & 1/2" TORQUE WRENCH SET FOAMX4

- Equipped with an in-built angular gauge for easier after tightening
- Click type mechanism to signal when the required torque is reached
- Additional ft/lb reference scale
- Marked to show the correct place where pressure should be applied
- Twist locking facility to ensure the set torque is maintained
- Reversible 24 teeth ratchet (DIN3122) giving 15° increments
- Designed to torque right hand (clockwise) fasteners
- Accurate to +/- 4% conforms to ISO6789 for assured accuracy
- Individually tested and certified at the time of manufacture
- Tools are held in place using three colour pre-cut EVA foam

Torque Wrenches

3/8" Drive 20-110Nm (15-81 ft/lb)

1/2" Drive 40-210Nm (30-150 ft/lb)

Item ID: **TEX1238**



Do's and Don'ts of Torque Wrenches

Do's

- **Use carefully:** Torque wrenches are a measuring instrument and need to be treated with care
- **Reset torque:** After use set the torque to its lowest setting. If you don't over time the springs inside the wrench can lose their normal tension
- **Store Safely:** All torque instruments should be stored in their original case
- **Keep wrench maintained:** Torque wrenches should be cleaned and calibrated on a yearly basis

Don't's

- **Use as a power bar:** Torque wrenches should never be used as a power bar to shift stubborn fastenings
- **Abuse your wrench:** Do not drop your torque wrench or overload the wrench with a pipe extension
- **Store in conditions that lead to corrosion:** Avoid any storage locations that are subject to high or low temperatures and high humidity
- **Use without PPE:** We recommend safety glasses when using any torque wrench or torque product

1/2" DRIVE



1/2"

1/2" TORQUE WRENCH

- Equipped with an in-built angular gauge for easier after tightening
- Click type mechanism to signal when the required torque is reached
- Additional ft/lb reference scale
- Marked to show the correct place where pressure should be applied
- Twist locking facility to ensure the set torque is maintained
- Reversible 24 teeth ratchet mechanism (DIN3122) giving 15° increments
- Designed to torque right hand (clockwise) fasteners
- Accurate to +/- 4% and conforms to ISO6789 for assured accuracy
- Each torque wrench has it's own individual certification number
- Supplied in a handy storage case

ITEM ID:	Updated Cert	Range		Scale		L mm	W mm	H mm	Weight g
		Nm	ft/lb	Nm	ft/lb				
1292AG-EP	-	40-210	30-150	1.0	1.0	465	46.9	33.4	1340
1292AGP-CT	Y	40-210	30-150	1.0	1.0	465	46.9	33.4	1340
1292AG-E4	-	70-350	50-250	5.0	5.0	632	47.1	37.1	2400
1292AG4-CT	Y	70-350	50-250	5.0	5.0	632	47.1	37.1	2400



1/2"

1/2" BI-DIRECTIONAL TORQUE WRENCH

- Equipped with an in-built angular gauge for easier after tightening
- Click type mechanism to signal when the required torque is reached
- Additional ft/lb reference scale
- Marked to show the correct place where pressure should be applied
- Twist locking facility to ensure the set torque is maintained
- Reversible 24 teeth ratchet mechanism (DIN3122) giving 15° increments
- For use with clockwise & anti-clockwise fastenings
- Switch direction by pushing through the square drive and turning the wrench over
- Accurate to +/- 4% and conforms to ISO6789 for assured accuracy
- Each torque wrench has it's own individual certification number
- Supplied in a handy storage case

ITEM ID:	Updated Cert	Range		Scale		L mm	W mm	H mm	Weight g
		Nm	ft/lb	Nm	ft/lb				
1292AG-ER	-	40-210	30-150	1.0	1.0	465	46.9	33.4	1340
1292AGR-CT	Y	40-210	30-150	1.0	1.0	465	46.9	33.4	1340
1292AG-E4R	-	70-350	50-250	5.0	5.0	632	47.1	37.1	2400
1292AG4R-CT	Y	70-350	50-250	5.0	5.0	632	47.1	37.1	2400



1/2"

1/2" TORQUE WRENCH PLUS

- Click type mechanism to signal when the required torque is reached
- Simple to adjust and easy to read Nm scale
- Locking button to ensure the set torque is securely maintained
- Compact head for easier use in confined spaces
- Quick release 72 teeth ratchet mechanism with twist reverse (DIN3122)
- Designed to torque right hand (clockwise) fasteners
- Ergonomic bi-material grip for added comfort
- Marked to show the correct place where pressure should be applied
- Hanging facility which can be used together with a fall protection wire
- Accurate to +/- 4% and conforms to ISO6789 for assured accuracy
- Each torque wrench has it's own individual certification number
- Supplied in a handy storage case

ITEM ID:	Updated Cert	Range		Scale	L mm	W mm	H mm	Weight g
		Nm	Nm					
1292P100	-	20-100	0.5	410	36	36	965	
1292P100-CT	Y	20-100	0.5	410	36	36	965	
1292P200	-	40-200	1.0	490	42	44	1465	
1292P200-CT	Y	40-200	1.0	490	42	44	1465	
1292P320	-	60-320	2.0	560	42	44	1645	
1292P320-CT	Y	60-320	2.0	560	42	44	1645	



1/2"

DIGITAL TORQUE WRENCH

- Simple to use with 9 separate torque settings
- Contains an insert head so can be used with 14x18mm insert tools
- Can be pre-programmed for different torque tolerances before use
- Audio visual warning with an indicator light to ensure the correct torque
- Easy to read digital scale showing Nm, ft/lb, in/lb or kg/m readings
- Marked to show the correct place where pressure should be applied
- Reversible 45 teeth quick release ratchet mechanism (DIN3122)
- Suitable for use on clockwise and anti-clockwise fastenings
- Accurate to +/- 1% and conforms to ISO6789 for assured accuracy
- Each torque wrench has it's own individual certification number
- Uses standard AA batteries for easy replacement
- Supplied in a handy storage case

ITEM ID:	Updated Cert	Range		Scale		L mm	W mm	H mm	Weight g
		Nm	ft/lb	Nm	ft/lb				
1292D200	-	20-200	30-150	0.1	0.1	548	42.5	46.5	1200
1292D200-CT	Y	20-200	30-150	0.1	0.1	548	42.5	46.5	1200



1/2"

1/2" PRESET TORQUE WRENCH

- Click type mechanism to signal when the required torque is reached
- Fixed setting for consistent torque application
- Robust 24 teeth ratchet mechanism for 15° increments
- Rubber grip for added comfort particularly with repeated use
- Accurate to +/- 4% conforms to ISO6789 for assured accuracy
- Individually tested and certified at the time of manufacture
- Rack included for storing the tools on a wall or workbench panel
- Designed and manufactured to DIN and ISO standards

ITEM ID:	Preset Torque		L mm	W mm	H mm	Weight g
	Nm	Nm				
1292AG-090	90	513	46.9	33.4	1400	
1292AG-110	110	513	46.9	33.4	1400	
1292AG-120	120	513	46.9	33.4	1400	
1292AG-140	140	513	46.9	33.4	1400	



TT SERIES
x4

1 Piece 1/2"

1/2" TORQUE WRENCH 40-210 NM TTX4

- Equipped with an in-built angular gauge for easier after tightening
- Additional ft/lb reference scale (range 30-150 ft/lb)
- Marked to show the correct place where pressure should be applied
- Twist locking facility to ensure the set torque is maintained
- Reversible 24 teeth ratchet (DIN3122) giving 15° increments
- Designed to torque right hand (clockwise) fasteners
- Accurate to +/- 4% conforms to ISO6789 for assured accuracy
- Individually tested and certified at the time of manufacture

1/2" Drive Torque wrench (40-210Nm, 30-150 ft/lb)

Item ID: **TTX1292**



TT SERIES
x4

1 Piece 1/2"

1/2" TORQUE WRENCH P-SERIES 40-200 NM TTX4

- Click type mechanism to signal when the required torque is reached
- Simple to adjust and easy to read Nm scale
- Locking button to ensure the set torque is securely maintained
- Compact head for easier use in confined spaces
- Quick release 72 teeth ratchet mechanism with twist reverse (DIN3122)
- Designed to torque right hand (clockwise) fasteners
- Ergonomic bi-material grip for added comfort
- Marked to show the correct place where pressure should be applied
- Hanging facility which can be used together with a fall protection wire
- Accurate to +/- 4% and conforms to ISO6789 for assured accuracy
- Each torque wrench has it's own individual certification number

1/2" Drive P-SERIES Torque wrench (40-200Nm)

Item ID: **TTXP1292**

3/4" DRIVE



3/4"

3/4" TORQUE WRENCH

- Equipped with an in-built angular gauge for easier after tightening
- Click type mechanism to signal when the required torque is reached
- Additional ft/lb reference scale
- Marked to show the correct place where pressure should be applied
- Twist locking facility to ensure the set torque is maintained
- Reversible 24 teeth ratchet mechanism (DIN3122) giving 15° increments
- Designed to torque right hand (clockwise) fasteners
- Accurate to +/- 4% and conforms to ISO6789 for assured accuracy
- Each torque wrench has it's own individual certification number
- Supplied in a handy storage case

ITEM ID:	Updated Cert	Range		Scale		L mm	W mm	H mm	Weight g
		Nm	ft/lb	Nm	ft/lb				
3492AG-E	-	65-450	48-330	5.0	5.0	850	72.5	53.5	3840
3492AG-CT	Y	65-450	48-330	5.0	5.0	850	72.5	53.5	3840
3492AG-E1	-	140-700	100-500	2.5	2.5	1065	72.5	53.5	5970
3492AG1-CT	Y	140-700	100-500	2.5	2.5	1065	72.5	53.5	5970
3492AG-E2	-	140-980	100-700	2.5	2.5	1213	72.5	53.5	6550
3492AG2-CT	Y	140-980	100-700	2.5	2.5	1213	72.5	53.5	6550



3/4"

3/4" BI-DIRECTIONAL TORQUE WRENCH

- Equipped with an in-built angular gauge for easier after tightening
- Click type mechanism to signal when the required torque is reached
- Additional ft/lb reference scale
- Marked to show the correct place where pressure should be applied
- Twist locking facility to ensure the set torque is maintained
- Reversible 24 teeth ratchet mechanism (DIN3122) giving 15° increments
- For use with clockwise & anti-clockwise fastenings
- Switch direction by pushing through the square drive and turning the wrench over
- Accurate to +/- 4% and conforms to ISO6789 for assured accuracy
- Each torque wrench has it's own individual certification number
- Supplied in a handy storage case

ITEM ID:	Updated Cert	Range		Scale		L mm	W mm	H mm	Weight g
		Nm	ft/lb	Nm	ft/lb				
3492AG-ER	-	65-450	48-330	5.0	5.0	850	72.5	53.5	3840
3492AGR-CT	Y	90-450	70-350	5.0	5.0	850	72.5	53.5	3840



3/4"

3/4" TORQUE WRENCH PLUS

- Click type mechanism to signal when the required torque is reached
- Simple to adjust and easy to read Nm scale
- Locking button to ensure the set torque is securely maintained
- Compact head for easier use in confined spaces
- Quick release 72 teeth ratchet mechanism with twist reverse (DIN3122)
- Designed to torque right hand (clockwise) fasteners
- Ergonomic bi-material grip for added comfort
- Marked to show the correct place where pressure should be applied
- Hanging facility which can be used together with a fall protection wire
- Accurate to +/- 4% and conforms to ISO6789 for assured accuracy
- Each torque wrench has it's own individual certification number
- Supplied in a handy storage case

ITEM ID:	Updated Cert	Range		Scale		L mm	W mm	H mm	Weight g
		Nm	ft/lb	Nm	ft/lb				
3492P500	-	100-500	75-360	2.5	2.5	790	68	62	3100
3492P500-CT	Y	100-500	75-360	2.5	2.5	790	68	62	3100

TORQUE WRENCH SERVICE KITS

- Includes a set of replacement parts for the ratchet mechanism

ITEM ID:	Drive	Service Kit For:
1492AGERK	1/4"	1492AG-E
3892AG1RK	3/8"	3892AG-E1
3892AG3RK	3/8"	3892AG-E3
3892P060RK-1	3/8"	3892P060, 3892P100
DTQ100RK	3/8"	3892D100
1292AGERK	1/2"	1292AG-E, 1292AG-EP, & Pre Set Range
1292AGERRK	1/2"	1292AG-ER
1292AG4RK	1/2"	1292AG-E4
1292AG4RRK	1/2"	1292AG-E4R
1292P100RK-1	1/2"	1292P100
1292P200RK-1	1/2"	1292P200
DTQ200RK	1/2"	1292D200
3492AGERRK	3/4"	3492AG-ER
3492AGERK	3/4"	3492AG-E, 3492AG-E1, 3492AG-E2
3492P500RK-1	3/4"	3492P500

ACCESSORIES



1/2"

INSERT TORQUE WRENCHES

- Click type mechanism to signal when the required torque is reached
- Simple to adjust and easy to read Nm scale
- Locking button to ensure the set torque is securely maintained
- Compact head for easier use in confined spaces
- Quick release 72 teeth ratchet mechanism with twist reverse (DIN3122)
- Designed to torque right hand (clockwise) fasteners
- Ergonomic bi-material grip for added comfort
- For use with the relevant insert torque tools
- Marked to show the correct place where pressure should be applied
- Hanging facility which can be used together with a fall protection wire
- Accurate to +/- 4% and conforms to ISO6789 for assured accuracy
- Each torque wrench has its own individual certification number
- Supplied in a handy storage case

ITEM ID:	Head Size	Range	Scale	L	W	H	Weight
		Nm	Nm				
1292P912	9x12	20-100	0.5	400	36	36	862
1292P418	14x18	40-200	1.0	560	42	44	1096



INSERT RATCHET HEADS

- 45 teeth ratchet
- Designed for use with the P-SERIES insert torque wrenches
- Use with 3/8", 1/2", & 3/4" drive sockets & accessories
- Satin finish

ITEM ID:	Fitting	W	H	L	LI	Weight
	mm	mm	mm	mm	mm	g
3892CQ100R	9 x 12	35	36.5	36.3	20	150
1292CQ200R	14 x 18	42.5	46	70.5	24.4	288
3492CQ500R	14 x 18	68.8	69.8	98	36	988

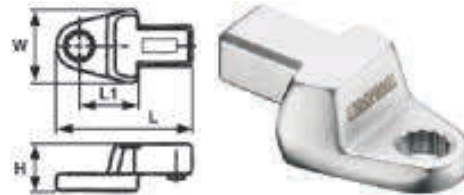

RING ENDED INSERT SPANNERS

- 9 x 12mm rectangular fitting
- 12 point bi-hexagon ring end for easier alignment
- For use with quick change open end torque wrenches
- Ideal for use in confined spaces
- Easy to change
- Satin finish chrome vanadium steel

ITEM ID:	Size	Fitting	W	H	L	LI	g
	mm	mm	mm	mm	mm	mm	g
690710	10	9 x 12	26.5	16	45	18	52
690711	11	9 x 12	26.5	16	45	18	50
690712	12	9 x 12	26.7	16	46	18	48
690713	13	9 x 12	27.2	16	49	20	60
690714	14	9 x 12	27	18	50	20	64
690715	15	9 x 12	27	18	50	20	64
690716	16	9 x 12	27	18	50	20	62
690717	17	9 x 12	28.6	18	54	22	74
690718	18	9 x 12	28.6	18	54	22	74
690719	19	9 x 12	28.6	18	54	22	68



Recalculate new torque setting if required:

New Torque = P x Ln / Le

- P = Desired Torque
- Ln = Normal Length
- Le = Extended Length

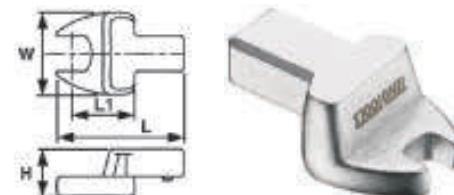

OPEN ENDED INSERT SPANNERS

- 9 x 12mm rectangular fitting
- For use with quick change open end torque wrenches
- Ideal for use in confined spaces
- Easy to change
- Satin finish chrome vanadium steel

ITEM ID:	Size	Fitting	W	H	L	LI	g
	mm	mm	mm	mm	mm	mm	g
690510	10	9 x 12	30	15	39	18	42
690511	11	9 x 12	30	15	39	18	43
690512	12	9 x 12	30	16	40	18	48
690513	13	9 x 12	30	16	42	20	52
690514	14	9 x 12	35	17	42	20	59
690515	15	9 x 12	35	17	43	20	59
690516	16	9 x 12	38	18	43	20	67
690517	17	9 x 12	38	18	44	20	67
690518	18	9 x 12	42	18	46	22	75
690519	19	9 x 12	42	18	46	22	75

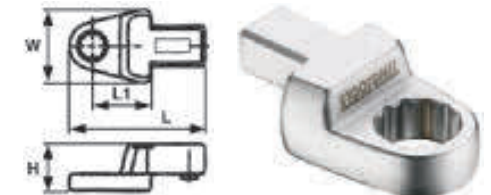

RING ENDED INSERT SPANNERS

- 12 point bi-hexagon ring end for easier alignment to the fastening
- 14 x 18mm rectangular fitting
- For use with quick change open end torque wrenches
- Ideal for use in confined spaces
- Easy to change
- Satin finish chrome vanadium steel

ITEM ID:	Size	Fitting	W	H	L	LI	g
	mm	mm	mm	mm	mm	mm	g
690813	13	14 x 18	38	22	72	32	200
690814	14	14 x 18	38	22	72	32	200
690815	15	14 x 18	38	22	73	32	194
690816	16	14 x 18	38	24	73	32	204
690817	17	14 x 18	38	24	73	32	194
690818	18	14 x 18	44	24	75	32	234
690819	19	14 x 18	44	24	75	32	230
690821	21	14 x 18	41	26	76	32	236
690822	22	14 x 18	42	25	77	32	250
690824	24	14 x 18	42	26	78	32	254
690826	26	14 x 18	42	26	78	32	240
690827	27	14 x 18	43.4	27	82	34	280
690829	29	14 x 18	43.3	28	85	36	306
690830	30	14 x 18	47.3	28	87	36	328
690832	32	14 x 18	47.3	29	87	36	312
690834	34	14 x 18	50	29	90	38	324
690836	36	14 x 18	52	29	91	38	316
690838	38	14 x 18	54.6	31	94	40	342
690840	40	14 x 18	54.6	30	93	40	367
690841	41	14 x 18	60	32	99	42	376
690842	42	14 x 18	60	32	99	42	376
690844	44	14 x 18	60	31	99	44	386
690846	46	14 x 18	64.8	32	103	42	396



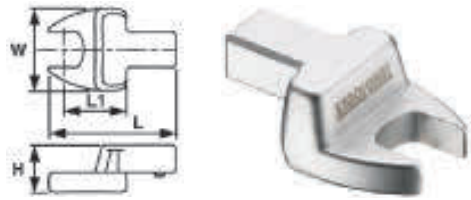

OPEN ENDED INSERT SPANNERS

- 14 x 18mm rectangular fitting
- For use with quick change open end torque wrenches
- Ideal for use in confined spaces
- Easy to change
- Satin finish chrome vanadium steel

ITEM ID:	Size mm	Fitting mm	W mm	H mm	L mm	LI mm	g
690613	13	14 x 18	35	21	63	32	148
690614	14	14 x 18	35	22	63	32	154
690615	15	14 x 18	35	23	64	32	154
690616	16	14 x 18	38	23	64	32	173
690617	17	14 x 18	38	23	64	32	173
690618	18	14 x 18	42	24	65	32	192
690619	19	14 x 18	42	25	65	32	193
690621	21	14 x 18	50	25	66	32	217
690622	22	14 x 18	53	26	66	32	222
690624	24	14 x 18	53	26	67	32	225
690626	26	14 x 18	60	27	70	33	273
690627	27	14 x 18	60	27	70	34	281
690629	29	14 x 18	66	28	74	36	312
690630	30	14 x 18	66	28	74	36	312
690632	32	14 x 18	66	29	77	38	322
690634	34	14 x 18	73	29	82	43	345
690636	36	14 x 18	73	29	82	42	368
690638	38	14 x 18	73	29	82	41	366
690640	40	14 x 18	82	29	83	42	383
690641	41	14 x 18	82	29	84	42	400
690642	42	14 x 18	82	29	83	42	410
690644	44	14 x 18	91	29	86	41	423
690646	46	14 x 18	91	29	86	43	436

ANGULAR GAUGE

- For measuring the degree of turn
- For use when after tightening of stretch bolts with torque wrenches that do not have an in-built angular gauge
- A static read off point, fixing magnet and a pair of angle scales make it possible to take a reading in most situations

Item ID: **TQAG**



3/4" 1"

TORQUE MULTIPLIER 1:3

- Ideal for tightening and loosening nuts and bolts where extra torque is required
- Supplied in a handy carrying case

ITEM ID:	Max Torque		Ratio	Diameter mm	Input Drive	Output Drive	Weight g
	Nm	ft/lb					
MP1400	1500	1100	1:3	69	1/2"	3/4"	2280
MP2700	3000	2200	1:3	92	3/4"	1"	4780



TORQUE MULTIPLIER SUPPORT LEG

- Fits on to the torque multiplier head or can be used as a support for the handle
- Designed to create a steady position for safer operation

ITEM ID:	Support Leg for:
MPSL01	MP1400
MPSL02	MP2700



3/4"

TORQUE MULTIPLIER 1:10

- Ideal for tightening and loosening nuts and bolts where extra torque is required
- Supplied in a handy carrying case

ITEM ID:	Max Torque		Ratio	Input Drive	Output Drive	Weight g
	Nm	ft/lb				
MP91500	1500	1100	1:10	1/2"	3/4"	3180

TORQUE MULTIPLIER SERVICE KITS

- Includes a set of replacement parts for the ratchet mechanism

ITEM ID:	Service Kit For:
MP1400RK-1	MP1400
MP2700RK-1	MP2700
MP91500RK	MP91500



TT SERIES

x4

2 Pieces

1/2"

3/4"

1/2" TORQUE MULTIPLIER SET TTX4 2 PIECES

- Includes a 1/2" drive torque wrench giving a range of 40 to 210Nm
- The MP1400 torque multiplier can be used to multiply the torque at a ratio of 1:3 increasing the potential torque to 630Nm
- For use with 3/4" drive sockets

1/2" Drive Torque wrench (40-210Nm, 30-150 ft/lb)

1/2"F:3/4"M Torque multiplier (1 to 3 ratio) and maximum torque capacity 1,500Nm

Item ID: **TTXMP12**



FOAM SERIES

x4

2 Pieces

1/2"

3/4"

1/2" TORQUE MULTIPLIER SET FOAMX4

- Includes a 1/2" drive torque wrench giving a range of 40 to 210Nm
- The MP1400 torque multiplier can then be used to multiply the torque at a ratio of 1:3 increasing the potential torque to 630Nm
- For use with 3/4" drive sockets
- Tools are held in place using three colour pre-cut EVA foam

1/2" Drive Torque wrench (40-210Nm, 30-150 ft/lb)

1/2"F:3/4"M Torque multiplier (1 to 3 ratio) and maximum torque capacity 1,500Nm

Item ID: **TEXMP12**



PRESET TORQUE SPANNER

- Pre-set open jaw torque spanners
- Ideal for air conditioning engineers
- Accurate to +/-4% and conforms to ISO6789

ITEM ID	Spanner Size mm	Pre-Set Torque Nm	Weight g
TQS018	17	18	396
TQS042	22	42	428
TQS055	26	55	546
TQS065	29	65	576



4 Pieces

TORQUE SPANNER SET 4 PIECES

- Ideal for air conditioning engineers
- Set of 4 pre-set open jaw torque spanners
- Accurate to +/- 4% and conforms to ISO6789 for assured accuracy
- Individually tested and certified at the time of manufacturer
- Supplied in a handy carrying case

Spanner Size mm	Pre-Set Torque Nm
17	18
22	42
26	55
29	65

Item ID: ACD01



DIGITAL TORQUE TESTER PRO

- For checking the accuracy of torque wrenches
- Designed for checking clockwise torque readings
- Accurate to +/-1% of the measurement value
- Very easy to use with full instructions included
- Robust construction with fixing points for installation on a solid surface
- Supplied with a factory test certificate

ITEM ID	Plug Type	Range Nm	Depth mm	Width mm	Height mm	Weight g
TORQ99E	Europe	10-400	200	160	85	2500
TORQ99U	UK	10-400	200	160	85	2500
TORQ99A	Aus / NZ	10-400	200	160	85	2500



DIGITAL TORQUE TESTER

- For checking the accuracy of torque wrenches
- Designed for checking clockwise torque readings
- Accurate to +/-1% of the measurement value
- Very easy to use with full instructions included
- Robust construction with fixing points for installation on a solid surface
- Supplied with a factory test certificate

ITEM ID	Plug Type	Range Nm	Depth mm	Width mm	Height mm	Weight g
TORQ02	Europe	1.5-30	205	155	76	2940
TORQ03	Europe	7.5-150	205	155	76	3940
TORQ04	Europe	25.500	205	155	76	4060
TORQ05	Europe	50-1000	205	155	76	4060
TORQ02U	UK	1.5-30	205	155	76	2940
TORQ03U	UK	7.5-150	205	155	76	3940
TORQ04U	UK	25.500	205	155	76	4060
TORQ05U	UK	50-1000	205	155	76	4060
TORQ02A	Aus / NZ	1.5-30	205	155	76	2940
TORQ03A	Aus / NZ	7.5-150	205	155	76	3940
TORQ04A	Aus / NZ	25.500	205	155	76	4060
TORQ05A	Aus / NZ	50-1000	205	155	76	4060



TORQUE TESTER STAND

- Designed for mounting the TORQ99 torque tester and the TORP01 printer
- Creates a stand alone torque testing work station
- A robust construction creates a good, stable working position
- It features a storage shelf and adjustable feet to ensure steadiness on uneven surfaces

ITEM ID	Depth mm	Width mm	Height mm	Weight g
TORQS01	570	340	950	1640



TORQUE TESTER PRINTER

- For use together with the TengTools TORQ99 digital torque tester
- Enables a printed record of each reading
- Very easy to use with full instructions included

ITEM ID	Plug Type	Depth mm	Width mm	Height mm	Weight g
TORP01E	Europe	220	180	95	1840
TORP01U	UK	220	180	95	1840
TORP01A	Aus / NZ	220	180	95	1840



*Torque wrench & socket not included

TORQUE TESTER PRINTER AND STAND

- A complete torque test centre
- Creates a stand alone torque testing work station
- Designed for checking clockwise torque wrench readings
- Accurate to +/-1% of the measurement value
- The printer enables a record to be kept of each reading
- Very easy to use with full instructions included
- The stand has a robust construction to create a stable working position
- It features a storage shelf and adjustable feet to ensure steadiness on uneven surfaces

ITEM ID	Plug Type	Range Nm	Depth mm	Width mm	Height mm	Weight g
TORQ	Europe	10-400	570	340	950	4350
TORQU	UK	10-400	570	340	950	4350
TORQA	Aus / NZ	10-400	570	340	950	4350

SPANNERS & WRENCHES

QUALITY AS STANDARD

Our range has been developed over many years with DIN and ISO standards as the lowest benchmark when it comes to quality and size tolerances. This is a policy that has resulted in many top positions on best-buy lists in consumer and trade magazines. The range includes many different types of spanners for most application areas and personal taste.

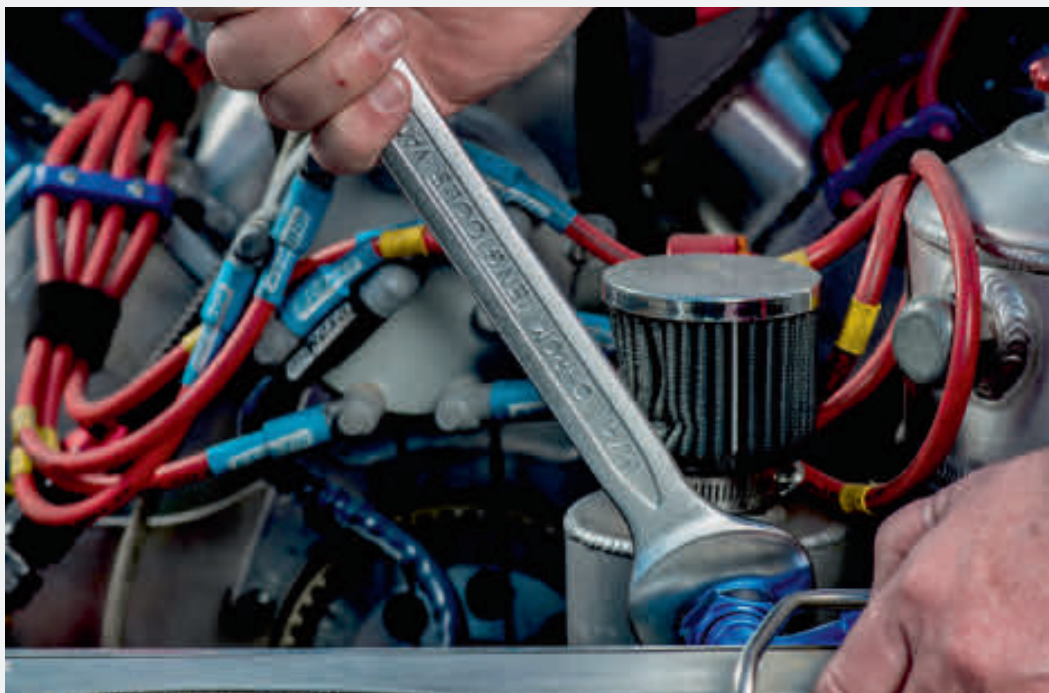

COMBINATION SPANNERS

High mechanical performance and optimized for increased accessibility complying with DIN and ISO standards

Manufactured and designed in accordance with DIN3113A in high grade chrome vanadium steel

Size clearly marked on the side of the spanner for easy & quick visibility

The ring head is offset 15° to facilitate use even on flat surfaces

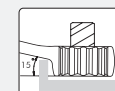

TengTools "Hip Grip" feature means the contact surface grips on the flat surfaces of the nut or bolt rather than on the corner



RATCHETING SPANNERS

'R' range contains a lever to quickly switch between left and right-hand action. With the 'RS' range you flip the spanner over to change ratcheting direction.

'R' range is offset at 15° for use against flat surfaces while the 'RS' range is straight to reach the nut flat



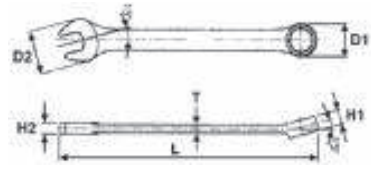

mm

COMBINATION SPANNER METRIC

- A ring and open ended spanner combined with the same size opening at each end
- Off set at 15° for easier use on flat surfaces
- TengTools hip grip design for contact with the flat side of the fastening
- Chrome vanadium satin finish
- Designed and manufactured to DIN3113A

ITEM ID:	Size mm	L mm	H1 mm	H2 mm	D1 mm	D2 mm	T mm	Weight g
6005055	5.5	95	4.1	3.5	8.9	13.6	2.4	11
600506	6	100	4.7	4	10.1	15.5	2.7	17
600507	7	110	5	4	11.5	17	2.8	23
600508	8	120	5.5	4.5	12.8	19.2	3	25
600509	9	130	5.9	4.5	14.2	21.2	3.3	28
600510	10	140	6.5	5	15.6	23.2	3.5	38
600511	11	150	6.9	5.4	16.9	25.3	3.7	47
600512	12	160	7.3	5.5	18.3	27.2	3.9	60
600513	13	170	7.8	5.9	19.7	29.4	4.1	68
600514	14	180	8.3	6.2	21.2	31.5	4.4	84
600515	15	190	8.6	6.4	22.5	33.2	4.6	98
600516	16	200	8.9	6.7	24	34.7	4.8	104
600517	17	210	9.3	6.9	25.3	36.5	5	124
600518	18	220	9.9	7.2	26.8	38.7	5.2	141
600519	19	230	10.5	7.4	28.1	40.7	5.4	158
600520	20	240	10.9	7.7	29.7	43.1	5.6	184
600521	21	250	11.3	8	31.3	44.8	5.7	209
600522	22	260	11.5	8.2	32.6	46.9	5.8	216
600523	23	270	11.8	8.4	34.2	48.3	5.9	258
600524	24	280	12.1	8.7	35.5	50.4	6	265
600525	25	290	12.5	8.9	36.9	52	6.2	296
600526	26	300	12.8	9.2	38.2	53.6	6.4	342
600527	27	310	13.1	9.4	39.6	55.7	6.6	385
600528	28	320	13.3	9.7	40.9	57.6	6.8	397
600529	29	330	13.5	9.9	42.3	59.7	7	435

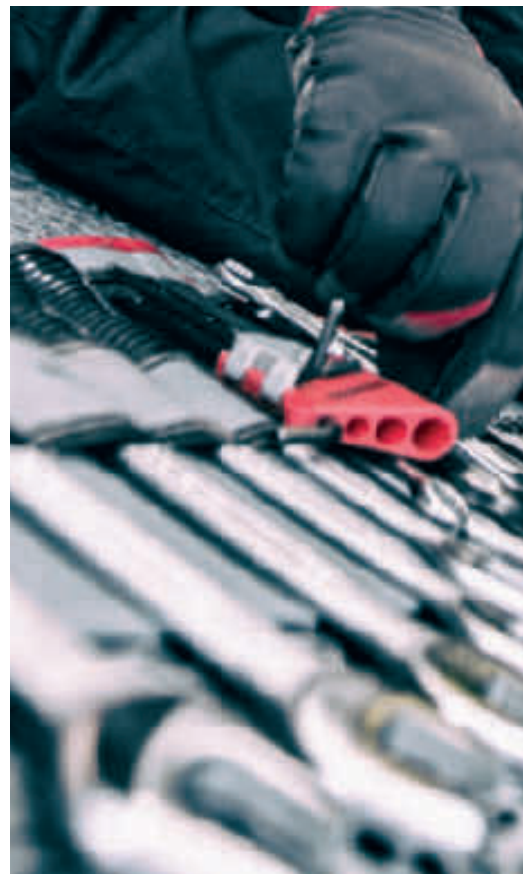

ITEM ID:	Size mm	L mm	H1 mm	H2 mm	D1 mm	D2 mm	T mm	Weight g
600530	30	340	13.7	10.1	43.7	61.8	7.1	459
600532	32	360	14.3	10.4	46.4	65.8	7.3	527
600533	33	380	15	10.7	48.8	69.2	7.5	654
600534	34	380	15	10.7	48.8	69.2	7.5	674
600536	36	410	19.2	13.5	53.5	74	8	831
600538	38	430	20.4	15	56	77	9	967
600541	41	460	21.6	16	61	84	10	1257
600546	46	500	23	17	66	92	11	1693
600550	50	540	24.6	18	73	102	12	2048
600555	55	560	21.5	28	86	118	14.5	2800
600558	58	600	23.5	30	94	126	16	3900
600560	60	600	23.5	30	94	126	16	3900
600565	65	680	25	32	108	148	18	5800
600570	70	680	25	32	108	148	18	5800

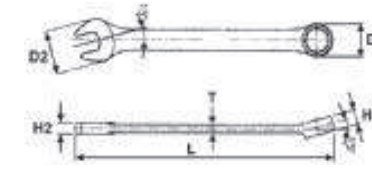

AF

COMBINATION SPANNER AF

- A ring and open ended spanner combined with the same size opening at each end
- Off set at 15° for easier use on flat surfaces
- TengTools hip grip design for contact with the flat side of the fastening
- Chrome vanadium satin finish
- Designed and manufactured to ASME B107.100

ITEM ID:	Size AF	L mm	H1 mm	H2 mm	D1 mm	D2 mm	T mm	Weight g
600108	1/4"	100	4.7	4	10.1	15.5	2.7	16
600110	5/16"	120	5.5	4.5	12.8	19.2	3	25
600112	3/8"	140	6.5	5	15.6	23.2	3.5	37
600114	7/16"	150	6.9	5.4	16.9	25.3	3.7	50
600116	1/2"	170	7.8	5.9	19.7	29.4	4.1	69
600118	9/16"	180	8.3	6.2	21.2	31.5	4.4	80
600120	5/8"	200	8.9	6.7	24	34.7	4.8	107
600122	11/16"	210	9.3	6.9	25.3	36.5	5	127
600124	3/4"	230	10.5	7.4	28.1	40.7	5.4	157
600126	13/16"	250	11.3	8	31.3	44.8	5.7	212
600128	7/8"	260	11.5	8.2	32.6	46.9	5.8	204
600130	15/16"	280	12.1	8.7	35.5	50.4	6	264
600132	1"	290	12.5	8.9	36.9	52	6.2	310
600134	1-1/16"	310	13.1	9.4	39.6	55.7	6.6	400
600136	1-1/8"	330	13.3	9.7	40.9	57.6	6.8	415
600140	1-1/4"	360	14.3	10.4	46.4	65.8	7.3	540
600142	1-5/16"	380	15	10.7	48.8	69.2	7.5	649
600144	1-3/8"	410	19.2	13.5	53	74	8	858
600146	1-7/16"	410	19.2	13.5	53	74	8	838
600148	1-1/2"	430	20.4	15	56	77	9	1002
600152	1-5/8"	460	21.6	16	61	84	10	1309
600156	1-3/4"	500	23	17	66	92	11	1595
600160	1-7/8"	540	24.6	18	73	102	12	2097



TT SERIES

1

12 Pieces

mm

COMBINATION SPANNER SET TTI 12 PIECES

- Off set at 15° for easier use on flat surfaces
- TengTools hip grip design for contact with the flat side of the fastening
- Chrome vanadium satin finish
- Designed and manufactured to DIN3113A

Combination Spanners:

8, 9, 10, 11, 12, 13, 14, 15, 16, 17, 18, 19 mm

Item ID: TTI236



TT SERIES

x4

7 Pieces

mm

COMBINATION SPANNER SET TTX4 7 PIECES

- Chrome vanadium, satin finish
- Off set at 15° for easier use on flat surfaces
- TengTools hip grip design for contact with the flat side of the fastening
- Designed and manufactured to DIN3113A

Combination Spanners:

20, 21, 22, 24, 27, 30, 32 mm

Item ID: TTX2032



TT SERIES

1

8 Pieces

AF

COMBINATION SPANNER SET AF TTI 8 PIECES

- Off set at 15° for easier use on flat surfaces
- TengTools hip grip design for contact with the flat side of the fastening
- Chrome vanadium satin finish
- Designed and manufactured to ASME B107.100

Combination Spanners:

5/16", 3/8", 7/16", 1/2", 9/16", 5/8", 11/16", 3/4"

Item ID: **TT3592**



TT SERIES

x4

7 Pieces

AF

COMBINATION SPANNER SET AF TTX4 7 PIECES

- Chrome vanadium, satin finish
- Off set at 15° for easier use on flat surfaces
- TengTools hip grip design for contact with the flat side of the fastening
- Designed and manufactured to ASME B107.100

Combination Spanners:

13/16", 7/8", 15/16", 1", 1-1/16", 1-1/8", 1-1/4"

Item ID: **TTX2640**

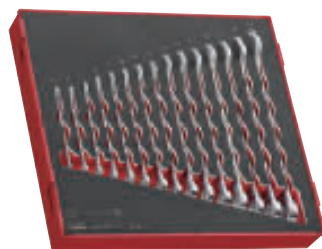

FOAM SERIES

2

15 Pieces

mm

COMBINATION SPANNER SET FOAM2 15 PIECES

- Off set at 15° for easier use on flat surfaces
- TengTools hip grip design for contact with the flat side of the fastening
- Tools are held in place using three colour pre-cut EVA foam
- Designed and manufactured to DIN3113A

Combination Spanners:

5.5, 6, 7, 8, 9, 10, 11, 12, 13, 14, 15, 16, 17, 18, 19 mm

Item ID: **TED6515**



FOAM SERIES

x4

7 Pieces

mm

COMBINATION SPANNER SET FOAMX4 7 PIECES

- Chrome vanadium, satin finish
- Off set at 15° for easier use on flat surfaces
- TengTools hip grip design for contact with the flat side of the fastening
- Tools are held in place using three colour pre-cut EVA foam
- Designed and manufactured to DIN3113A

Combination Spanners:

20, 21, 22, 24, 27, 30, 32 mm

Item ID: **TEX2032**



12 Pieces

mm

COMBINATION SPANNER 8-19 MM WALL RACK

- Off set at 15° for easier use on flat surfaces
- TengTools hip grip design for contact with the flat side of the fastening
- Chrome vanadium satin finish
- Supplied with a wall rack for fixing to the wall or a workbench
- Designed and manufactured to DIN3113A

Combination Spanners:

8, 9, 10, 11, 12, 13, 14, 15, 16, 17, 18, 19 mm

Item ID: **WRSP12**



12 Pieces

mm

COMBINATION SPANNER SET 8-19 MM 12 PIECES

- Off set at 15° for easier use on flat surfaces
- TengTools hip grip design for contact with the flat side of the fastening
- Chrome vanadium satin finish
- Designed and manufactured to DIN3113A

Combination Spanners:

8, 9, 10, 11, 12, 13, 14, 15, 16, 17, 18, 19 mm

Item ID: **6512N**



12 Pieces

mm

COMBINATION SPANNER SET 8-22 MM 12 PIECES

- Off set at 15° for easier use on flat surfaces
- TengTools hip grip design for contact with the flat side of the fastening
- Chrome vanadium satin finish
- Designed and manufactured to DIN3113A

Combination Spanners:

8, 9, 10, 11, 12, 13, 14, 15, 16, 17, 19, 22 mm

Item ID: **6512**



17 Pieces

mm

COMBINATION SPANNER SET 6-22 MM 17 PIECES

- Off set at 15° for easier use on flat surfaces
- TengTools hip grip design for contact with the flat side of the fastening
- Chrome vanadium satin finish
- Designed and manufactured to DIN3113A

Combination Spanners:

6, 7, 8, 9, 10, 11, 12, 13, 14, 15, 16, 17, 18, 19, 20, 21, 22 mm

Item ID: **6517**



21 Pieces mm

COMBINATION SPANNER SET 6-32 MM 21 PIECES

- Off set at 15° for easier use on flat surfaces
- TengTools hip grip design for contact with the flat side of the fastening
- Chrome vanadium satin finish
- Designed and manufactured to DIN3113A

Combination Spanners:

6, 7, 8, 9, 10, 11, 12, 13, 14, 15, 16, 17, 18, 19, 20, 21, 22, 24, 27, 30, 32 mm

Item ID: **6521**



10 Pieces mm

COMBINATION SPANNER SET 8-19 MM TOOL ROLL 10 PIECES

- Off set at 15° for easier use on flat surfaces
- TengTools hip grip design for contact with the flat side of the fastening
- Chrome vanadium satin finish
- Supplied in a handy tool roll style wallet
- Designed and manufactured to DIN3113A

Combination Spanners:

8, 9, 10, 11, 12, 13, 14, 15, 17, 19 mm

Item ID: **6510MM**



12 Pieces mm

COMBINATION SPANNER SET 8-19 MM TOOL ROLL 12 PIECES

- Off set at 15° for easier use on flat surfaces
- TengTools hip grip design for contact with the flat side of the fastening
- Chrome vanadium satin finish
- Supplied in a handy tool roll style wallet
- Designed and manufactured to DIN3113A

Combination Spanners:

8, 9, 10, 11, 12, 13, 14, 15, 16, 17, 18, 19 mm

Item ID: **6512MM1**



15 Pieces mm

COMBINATION SPANNER SET 5.5-19 MM TOOL ROLL 15 PIECES

- Off set at 15° for easier use on flat surfaces
- TengTools hip grip design for contact with the flat side of the fastening
- Chrome vanadium satin finish
- Supplied in a handy tool roll style wallet
- Designed and manufactured to DIN3113A

Combination Spanners:

5.5, 6, 7, 8, 9, 10, 11, 12, 13, 14, 15, 16, 17, 18, 19 mm

Item ID: **6515MM**



17 Pieces mm

COMBINATION SPANNER SET 6-22 MM TOOL ROLL 17 PIECES

- Off set at 15° for easier use on flat surfaces
- TengTools hip grip design for contact with the flat side of the fastening
- Chrome vanadium satin finish
- Supplied in a handy tool roll style wallet
- Designed and manufactured to DIN3113A

Combination Spanners:

6, 7, 8, 9, 10, 11, 12, 13, 14, 15, 16, 17, 18, 19, 20, 21, 22 mm

Item ID: **6517MM**



12 Pieces mm

COMBINATION SPANNER SET 20-32 MM TOOL ROLL 12 PIECES

- Off set at 15° for easier use on flat surfaces
- TengTools hip grip design for contact with the flat side of the fastening
- Chrome vanadium satin finish
- Supplied in a handy tool roll style wallet
- Designed and manufactured to DIN3113A

Combination Spanners:

20, 21, 22, 23, 24, 25, 26, 27, 28, 29, 30, 32 mm

Item ID: **6512MM**

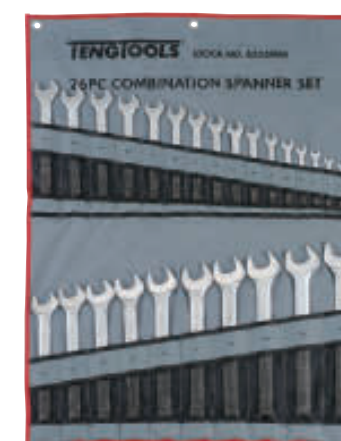

26 Pieces mm

COMBINATION SPANNER SET 6-32 MM TOOL ROLL 32 PIECES

- Off set at 15° for easier use on flat surfaces
- TengTools hip grip design for contact with the flat side of the fastening
- Chrome vanadium satin finish
- Supplied in a handy tool roll style wallet
- Designed and manufactured to DIN3113A

Combination Spanners:

6, 7, 8, 9, 10, 11, 12, 13, 14, 15, 16, 17, 18, 19, 20, 21, 22, 23, 24, 25, 26, 27, 28, 29, 30, 32 mm

Item ID: **6526MM**



7 Pieces mm

COMBINATION SPANNER SET 33-50 MM TOOL ROLL 7 PIECES

- Off set at 15° for easier use on flat surfaces
- TengTools hip grip design for contact with the flat side of the fastening
- Chrome vanadium satin finish
- Supplied in a handy tool roll style wallet
- Designed and manufactured to DIN3113A

Combination Spanners:

33, 34, 36, 38, 41, 46, 50 mm

Item ID: **6507JMM**



9 Pieces AF

COMBINATION SPANNER SET 1/4"-3/4" TOOL ROLL 9 PIECES

- Off set at 15° for easier use on flat surfaces
- TengTools hip grip design for contact with the flat side of the fastening
- Chrome vanadium satin finish
- Supplied in a handy tool roll style wallet
- Designed and manufactured to ASME B107.100

Combination Spanners:

1/4", 5/16", 3/8", 7/16", 1/2", 9/16", 5/8", 11/16", 3/4"

Item ID: **6509AF**



7 Pieces AF

COMBINATION SPANNER SET 13/16"-1 1/4" TOOL ROLL 7 PIECES

- Off set at 15° for easier use on flat surfaces
- TengTools hip grip design for contact with the flat side of the fastening
- Chrome vanadium satin finish
- Supplied in a handy tool roll style wallet
- Designed and manufactured to ASME B107.100

Combination Spanners:

13/16", 7/8", 15/16", 1", 1-1/16", 1-1/8", 1-1/4"

Item ID: **6507AF**



7 Pieces AF

COMBINATION SPANNER SET 1 5/16"-1 7/8" TOOL ROLL 7 PIECES

- Off set at 15° for easier use on flat surfaces
- TengTools hip grip design for contact with the flat side of the fastening
- Chrome vanadium satin finish
- Supplied in a handy tool roll style wallet
- Designed and manufactured to ASME B107.100

Combination Spanners:

1-5/16", 1-3/8", 1-7/16", 1-1/2", 1-5/8", 1-3/4", 1-7/8"

Item ID: **6507JAF**



10 Pieces mm

COMBINATION SPANNER SET 8-19 MM PLASTIC HOLDER 10 PIECES

- Off set at 15° for easier use on flat surfaces
- TengTools hip grip design for contact with the flat side of the fastening
- Chrome vanadium satin finish
- Supplied in a holder that can be used for storage or for mounting on a wall
- Designed and manufactured to DIN3113A

Combination Spanners:

8, 10, 11, 12, 13, 14, 15, 16, 17, 19 mm

Item ID: **6510A**

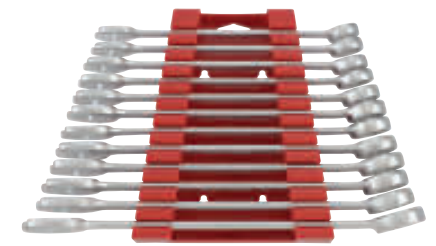

12 Pieces mm

COMBINATION SPANNER SET 20-32 MM PLASTIC HOLDER 12 PIECES

- Off set at 15° for easier use on flat surfaces
- TengTools hip grip design for contact with the flat side of the fastening
- Chrome vanadium satin finish
- Spanner holder can be used on it's own or it can be connected to sets: 6512MMA and/or 6507JMMMA
- Designed and manufactured to DIN3113A

Combination Spanners:

20, 21, 22, 23, 24, 25, 26, 27, 28, 29, 30, 32 mm

Item ID: **6512MMA**

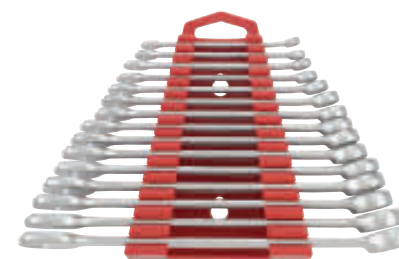

15 Pieces mm

COMBINATION SPANNER SET 5.5-19 MM PLASTIC HOLDER 15 PIECES

- Off set at 15° for easier use on flat surfaces
- TengTools hip grip design for contact with the flat side of the fastening
- Chrome vanadium satin finish
- Spanner holder can be used on it's own or it can be connected to set: 6512MMA
- Designed and manufactured to DIN3113A

Combination Spanners:

5.5, 6, 7, 8, 9, 10, 11, 12, 13, 14, 15, 16, 17, 18, 19 mm

Item ID: **6515MMA**



7 Pieces mm

COMBINATION SPANNER SET 33-50 MM PLASTIC HOLDER 7 PIECES

- Off set at 15° for easier use on flat surfaces
- TengTools hip grip design for contact with the flat side of the fastening
- Chrome vanadium satin finish
- Spanner holder can be used on it's own or it can be connected to set: 6512MMA
- Designed and manufactured to DIN3113A

Combination Spanners:

33, 34, 36, 38, 41, 46, 50 mm

Item ID: **6507JMMMA**

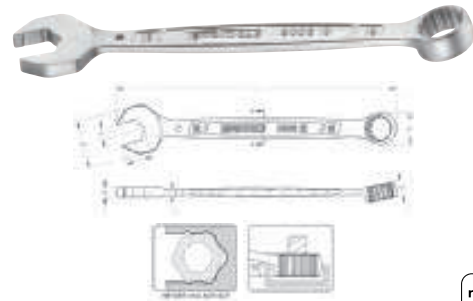

mm

COMBINATION SPANNER ANTI SLIP METRIC

- Anti slip metric combination spanner
- Off set at 15° for easier use on flat surfaces
- TengTools hip grip design on the ring and open end for contact with the flat side of the fastening
- TengTools anti slip design on the open end to give a much better grip with less risk of damaging the fastening

ITEM ID:	Size mm	L mm	H1 mm	H2 mm	D1 mm	D2 mm	T mm	Weight g
800608	8	120	6.6	4.5	12.8	18.9	3.2	24
800609	9	130	7	4.5	14.2	20.8	3.2	28
800610	10	140	7.7	5	15.6	22.5	3.6	36
800611	11	150	8.4	5.4	16.9	24.5	3.6	46
800612	12	160	8.5	5.5	18	27.2	3.6	58
800613	13	170	8.8	5.9	19.5	29.6	3.9	71
800614	14	180	9.6	6.2	21.5	31.1	4	81
800615	15	185	10.1	6.4	22.8	32.5	4.2	93
800616	16	195	10.5	6.5	24.2	35	4.5	110
800617	17	202	11	6.9	25.2	37	4.5	123
800618	18	208	11.5	7.1	26.8	39	4.8	135
800619	19	218	12.2	7.5	28.4	41.1	5	156



TengTools "Hip Grip" feature means the contact surface grips on the flat surfaces of the nut or bolt rather than on the corner. This helps to prevent damage and makes it possible to grip nuts and bolts which already have damaged corners.

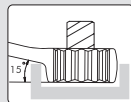
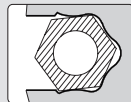

TT SERIES



12 Pieces

mm



COMBINATION SPANNER SET ANTI SLIP TT1

- Off set at 15° for easier use on flat surfaces
- TengTools hip grip design for contact with the flat side of the fastening
- TengTools anti slip design on the open end to give a much better grip

Combination Spanners:

8, 9, 10, 11, 12, 13, 14, 15, 16, 17, 18, 19 mm



Item ID: **TT8012**

FOAM SERIES



12 Pieces

mm



COMBINATION SPANNER SET ANTI SLIP FOAM2

- Off set at 15° for easier use on flat surfaces
- TengTools hip grip design on the ring and open end for contact with the flat side of the fastening
- TengTools anti slip design on the open end to give a much better grip
- Tools are held in place using three colour pre-cut EVA foam

Combination Spanners:

8, 9, 10, 11, 12, 13, 14, 15, 16, 17, 18, 19 mm



Item ID: **TED8012**

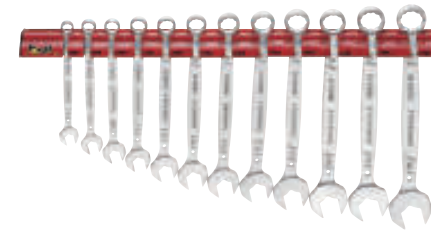

12 Pieces

mm

COMBINATION SPANNER ANTI SLIP WALL RACK

- Off set at 15° for easier use on flat surfaces
- TengTools hip grip design on the ring and open end for contact with the flat side of the fastening
- TengTools anti slip design on the open end to give a much better grip
- Supplied with a wall rack for fixing to the wall or a workbench

Anti Slip Combination Spanners:

8, 9, 10, 11, 12, 13, 14, 15, 16, 17, 18, 19 mm

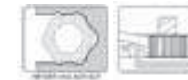

Item ID: **WR8012**



12 Pieces

mm

COMBINATION SPANNER SET ANTI SLIP PLASTIC HOLDER 12 PIECES

- Off set at 15° for easier use on flat surfaces
- TengTools hip grip design on the ring and open end for contact with the flat side of the fastening
- TengTools anti slip design on the open end to give a much better grip with less risk of damaging the fastening
- Supplied in a holder that can be used for storage or for mounting on a wall

Anti Slip Combination Spanners:

8, 9, 10, 11, 12, 13, 14, 15, 16, 17, 18, 19 mm



Item ID: **8512A**



12 Pieces

mm

COMBINATION SPANNER SET ANTI SLIP TOOL ROLL 12 PIECES

- Off set at 15° for easier use on flat surfaces
- TengTools hip grip design on the ring and open end for contact with the flat side of the fastening
- TengTools anti slip design on the open end to give a much better grip with less risk of damaging the fastening
- Supplied in a handy tool roll style wallet

Anti Slip Combination Spanners:

8, 9, 10, 11, 12, 13, 14, 15, 16, 17, 18, 19 mm



Item ID: **8512MM**

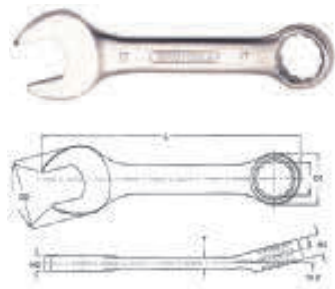

mm

STUBBY COMBINATION SPANNER METRIC

- Ideal for use in confined spaces
- Off set at 15° for easier use on flat surfaces
- TengTools hip grip design for contact with the flat side of the fastening
- Chrome vanadium satin finish
- Designed and manufactured to DIN3113A

ITEM ID:	Size mm	L mm	H1 mm	H2 mm	D1 mm	D2 mm	T mm	Weight g
6005M10	10	95	7	5.1	16.2	21.9	3.4	30
6005M11	11	100	7.8	5.9	17.9	23.8	4	42
6005M12	12	105	8.2	6.6	19.1	24.7	4.2	48
6005M13	13	110	8.8	6.7	19.3	27.1	5	55
6005M14	14	115	9.1	7.4	21.8	28.9	5.1	66
6005M15	15	120	9.2	7.5	22.6	31.1	5.1	71
6005M16	16	125	9.8	8.1	23.6	33	5.6	87
6005M17	17	130	10.3	8.3	25.9	36	5.6	105
6005M18	18	135	11	8.7	27.2	36.8	5.8	118
6005M19	19	140	11.2	9.4	28.7	38.1	6	130



TT SERIES

1

10 Pieces

mm

STUBBY COMBINATION SPANNER SET TTI

- Short stubby spanners for use in confined spaces
- Off set at 15° for easier use on flat surfaces
- TengTools hip grip design for contact with the flat side of the fastening
- Chrome vanadium satin finish
- Designed and manufactured to DIN3113A

Midget Combination Spanners:

10, 11, 12, 13, 14, 15, 16, 17, 18, 19 mm

Item ID: **TT6010M**

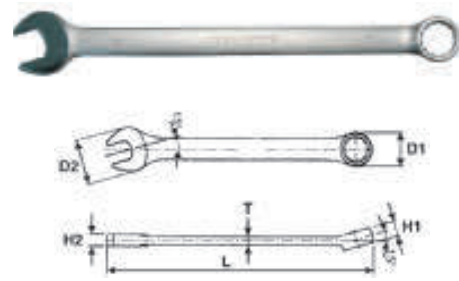

mm

LONG COMBINATION SPANNER METRIC

- Extra long metric combination spanner
- A ring and open ended spanner combined with the same size opening at each end
- Off set at 15° for easier use on flat surfaces
- TengTools hip grip design on the ring end for contact with the flat side of the fastening for reduced damage and use on rounded nuts and bolts
- Chrome vanadium satin finish
- Designed and manufactured to DIN3113A

ITEM ID:	Size mm	L mm	H1 mm	H2 mm	D1 mm	D2 mm	T mm	Weight g
605908	8	148	5.3	4.9	12.6	17.2	3.6	33
605909	9	158	6.2	5	13.7	19.4	3.8	40
605910	10	168	6.4	5.6	15.2	21.7	3.9	50
605911	11	188	7.3	5.6	16.7	23.1	4.2	62
605912	12	198	7.9	6.3	17.7	25.3	4.2	77
605913	13	208	8.6	6.7	19.8	26.6	4.5	87
605914	14	228	9	7.4	21.4	29.8	5	117
605915	15	238	9.9	7.6	22.5	32.4	5	142
605916	16	246	10.4	8.2	23.5	32.4	5.2	153
605917	17	266	10.5	8.2	25.4	36	5.8	174
605918	18	276	12.4	9	26.6	37.4	5.8	215
605919	19	285	12.6	9.1	28.3	39.8	6.1	220



TT SERIES

x4

12 Pieces

mm

LONG COMBINATION SPANNER SET TTX4

- Extra long for increased torque
- Off set at 15° for easier use on flat surfaces
- TengTools hip grip design for contact with the flat side of the fastening
- Designed and manufactured to DIN3113A

Long Combination Spanners:

8, 9, 10, 11, 12, 13, 14, 15, 16, 17, 18, 19 mm

Item ID: **TTXLMP12**



12 Pieces

mm

LONG COMBINATION SPANNER WALL RACK

- Extra long for increased torque
- Off set at 15° for easier use on flat surfaces
- TengTools hip grip design for contact with the flat side of the fastening
- Supplied with a wall rack for fixing to the wall or a workbench
- Designed and manufactured to DIN3113A

Long Combination Spanners:

8, 9, 10, 11, 12, 13, 14, 15, 16, 17, 18, 19 mm

Item ID: **WRSP12LMP**



9 Pieces

mm

LONG COMBINATION SPANNER SET 8-19 MM TOOL ROLL 9 PIECES

- Extra long for increased torque
- Off set at 15° for easier use on flat surfaces
- TengTools hip grip design for contact with the flat side of the fastening
- Supplied in a handy tool roll style wallet
- Designed and manufactured to DIN3113A

Long Combination Spanners:

8, 10, 11, 12, 13, 14, 15, 17, 19 mm

Item ID: **6059LMP**



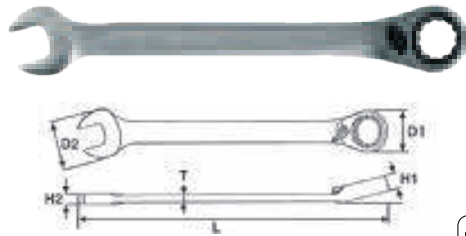

mm

RATCHETING COMBINATION SPANNER METRIC R

- A ratcheting ring and open ended spanner combined with the same size at each end
- Off set at 13° for easier use on flat surfaces
- TengTools hip grip design on the ring end for contact with the flat side of the fastening
- 72 teeth ratchet spanners giving a 5° increment between clicks
- Reversible ratchet mechanism with a flip reverse lever
- Ideal for rapid tightening and loosening of fastenings
- Chrome vanadium satin finish
- Designed and manufactured to DIN ISO 1711-1 and DIN 3113A

ITEM ID:	Size mm	L mm	H1 mm	H2 mm	D1 mm	D2 mm	T mm	Weight g
600508R	8	140	6.5	4	17	17	2.8	30
600509R	9	150	6.9	4.4	18.5	19	2.7	30
600510R	10	159	7.3	4.8	20	21	3.3	50
600511R	11	165	7.7	5.2	22	23	3.6	70
600512R	12	172	8.2	5.5	23	25	3.9	80
600513R	13	178	8.5	5.8	25	27	4	100
600514R	14	191	9	6.2	27	29	4.3	120
600515R	15	200	9.4	6.5	28	31	4.5	140
600516R	16	208	9.9	6.8	30	33	4.7	170
600517R	17	226	10.3	7.2	32	36	5	200
600518R	18	237	10.7	7.7	33	38	5.2	210
600519R	19	248	11.2	8.2	34	40	5.5	220
600522R	22	290	13	9	38.4	45	6	360
600524R	24	323	14.5	9.8	43.6	52	6.5	510
600527R	27	359	15.5	10.5	52.5	56	7.7	640
600530R	30	403	17	11.4	58.5	59	8.2	880
600532R	32	425	17.5	12.5	62.5	63	8.7	1080

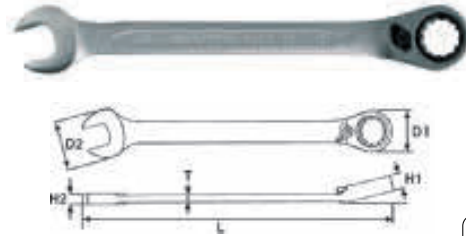

AF

RATCHETING COMBINATION SPANNER AF R

- A ratcheting ring and open ended spanner combined with the same size at each end
- Off set at 13° for easier use on flat surfaces
- TengTools hip grip design on the ring end for contact with the flat side of the fastening
- 72 teeth ratchet spanners giving a 5° increment between clicks
- Reversible ratchet mechanism with a flip reverse lever
- Ideal for rapid tightening and loosening of fastenings
- Chrome vanadium satin finish
- Manufactured to DIN ISO 1711-1 and ASME B107.100

ITEM ID:	Size AF	L mm	H1 mm	H2 mm	D1 mm	D2 mm	T mm	Weight g
600110R	5/16"	140	6.5	4.6	16.6	16.7	3	30
600112R	3/8"	159	7.3	5.3	20	20.8	3.4	50
600114R	7/16"	165	7.7	5.6	21.8	23	3.7	70
600116R	1/2"	178	8.6	6.4	24.7	27.1	4.1	100
600118R	9/16"	191	9	6.8	27	29.2	4.4	120
600120R	5/8"	208	9.9	7.2	30	33.4	4.7	170
600122R	11/16"	226	10.3	7.7	31.8	35.5	5.1	200
600124R	3/4"	248	11.2	8.8	33.8	39.7	5.6	320
600126R	13/16"	290	13	9	40	46	6	360
600128R	7/8"	290	13	9	40	46	6	510



TT SERIES
1

8 Pieces mm

RATCHETING COMBI SPANNER SET R TT

- 72 teeth ratchet spanners giving a 5° increment between clicks
- Reversible ratchet mechanism with a flip reverse lever
- TengTools hip grip design on the ring end
- Chrome vanadium satin finish
- Designed and manufactured to DIN ISO 1711-1 and DIN 3113A

Ratchet Spanners with flip reverse switch:
8, 10, 11, 12, 13, 14, 17, 19 mm

Item ID: **TT6508R**



TT SERIES
1

11 Pieces mm

RATCHETING COMBI SPANNER SET R TT1

- 72 teeth ratchet spanners giving a 5° increment between clicks
- Reversible ratchet mechanism with hip grip & flip reverse lever
- Chrome vanadium satin finish
- Designed and manufactured to DIN ISO 1711-1 and DIN 3113A

Ratchet Spanners with flip reverse switch:
8, 10, 11, 12, 13, 14, 15, 16, 17, 18, 19 mm

Item ID: **TT6511R**



TT SERIES
1

8 Pieces AF

RATCHETING COMBI SPANNER SET R AF TT

- 72 teeth ratchet spanners giving a 5° increment between clicks
- Reversible ratchet mechanism with a flip reverse lever
- Chrome vanadium satin finish
- Manufactured to DIN ISO 1711-1 and ASME B107.100

Ratchet Spanners with flip reverse switch:
5/16", 3/8", 7/16", 1/2", 9/16", 5/8", 11/16", 3/4"

Item ID: **TT6508RAF**



FOAM SERIES
2

12 Pieces mm

RATCHETING COMBI SPANNER SET R FOAM2

- 72 teeth ratchet spanners giving a 5° increment between clicks
- Reversible ratchet mechanism with hip grip & flip reverse lever
- Tools are held in place using three colour pre-cut EVA foam
- Designed and manufactured to DIN ISO 1711-1 and DIN 3113A

Ratchet Spanners with flip reverse switch:
8, 9, 10, 11, 12, 13, 14, 15, 16, 17, 18, 19 mm

Item ID: **TED6512R**



8 Pieces mm

RATCHETING COMBINATION SPANNER SET R TOOL ROLL 8 PIECES

- 72 teeth ratchet spanners giving a 5° increment between clicks
- Reversible ratchet mechanism with hip grip & flip reverse lever
- Chrome vanadium satin finish
- Supplied in a handy tool roll style wallet
- Designed and manufactured to DIN ISO 1711-1 and DIN 3113A

Ratchet Spanners with flip reverse switch:
8, 10, 11, 12, 13, 14, 17, 19 mm

Item ID: **6508RMM**



10 Pieces mm

RATCHETING COMBINATION SPANNER SET R TOOL ROLL 10 PIECES

- 72 teeth ratchet spanners giving a 5° increment between clicks
- Reversible ratchet mechanism with hip grip & flip reverse lever
- Chrome vanadium satin finish
- Supplied in a handy tool roll style wallet
- Designed and manufactured to DIN ISO 1711-1 and DIN 3113A

Ratchet Spanners with flip reverse switch:
10, 11, 12, 13, 14, 15, 16, 17, 18, 19 mm

Item ID: **6510RMM**

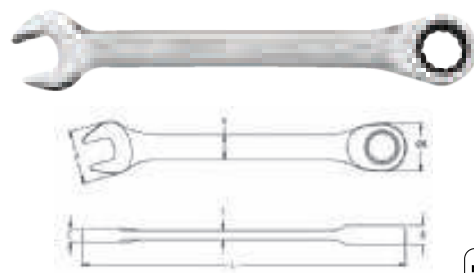

mm

RATCHETING COMBINATION SPANNER METRIC RS

- A ratcheting ring and open ended spanner combined with the same size at each end
- Simply turn over to reverse the direction of use when ratcheting
- TengTools hip grip design on the ring end for contact with the flat side of the fastening
- 72 teeth ratchet spanners giving a 5° increment between clicks
- Ideal for rapid tightening and loosening of fastenings
- Chrome vanadium satin finish
- Designed and manufactured to DIN ISO 1711-1 and DIN 3113A

ITEM ID:	Size mm	L mm	A mm	B mm	C mm	D mm	H mm	T mm	Weight g
600508RS	8	111	19.6	17	4	6.8	8	2.8	30
600509RS	9	123	20.8	19	4.4	7.2	9	2.9	41
600510RS	10	131	22	20	4.8	7.6	9.5	3.3	48
600511RS	11	147	24.2	21	5.2	8	10	3.6	62
600512RS	12	155	25.7	23	5.5	8.5	11	3.9	78
600513RS	13	164	27.2	25	5.8	8.9	12	4	88
600514RS	14	182	30.8	27	6.2	9.3	13	4.3	112
600515RS	15	192	32.4	28	6.5	9.7	13.6	4.5	123
600516RS	16	202	34	30	6.8	10.2	14.4	4.7	144
600517RS	17	223	37.7	32	7.2	10.6	15.3	5	192
600518RS	18	234	39.3	33	7.7	11	16.2	5.2	207
600519RS	19	246	40.8	34	8.2	11.5	17	5.5	233
600520RS	20	285	46	42	10	13	18.8	6.4	385
600521RS	21	285	46	42	10	13	18.8	6.4	385
600522RS	22	285	46	42	10	13	18.8	6.4	387
600524RS	24	325	51.5	47.5	11	14.5	20.6	7	511



TT SERIES
1

8 Pieces mm

RATCHETING COMBI SPANNER SET RS TT1

- 72 teeth ratchet spanners giving a 5° increment between clicks
- Simply turn over to reverse the direction of use when ratcheting
- Chrome vanadium satin finish
- Designed and manufactured to DIN ISO 1711-1 & DIN 3113A

Ratchet Spanners:
8, 10, 11, 12, 13, 14, 17, 19 mm

Item ID: **TT6508RS**



TT SERIES
1

11 Pieces mm

RATCHETING COMBI SPANNER SET RS TT1

- 72 teeth ratchet spanners giving a 5° increment between clicks
- Hip grip on the ring end, turn spanner over to change direction
- Chrome vanadium satin finish
- Designed and manufactured to DIN ISO 1711-1 and DIN 3113A

Ratchet Spanners:
8, 10, 11, 12, 13, 14, 15, 16, 17, 18, 19 mm

Item ID: **TT6511RS**

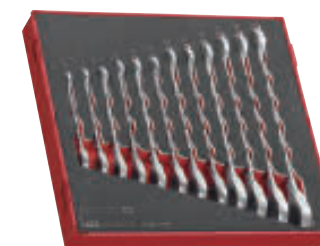

FOAM SERIES
2

12 Pieces mm

RATCHETING COMBI SPANNER SET RS FOAM2

- 72 teeth ratchet spanners giving a 5° increment between clicks
- Hip grip on the ring end, turn spanner over to change direction
- Tools are held in place using three colour pre-cut EVA foam
- Designed and manufactured to DIN ISO 1711-1 and DIN 3113A

Ratchet Spanners:
8, 9, 10, 11, 12, 13, 14, 15, 16, 17, 18, 19 mm

Item ID: **TED6512RS**



12 Pieces mm

RATCHETING COMBI SPANNER RS WALL RACK

- 72 teeth ratchet spanners giving a 5° increment between clicks
- Simply turn over to reverse the direction of use when ratcheting
- Chrome vanadium satin finish
- Supplied with a wall rack for fixing to the wall or a workbench
- Designed and manufactured to DIN ISO 1711-1 and DIN 3113A

Ratchet Spanners:
8, 9, 10, 11, 12, 13, 14, 15, 16, 17, 18, 19 mm

Item ID: **WRSP12RS**



8 Pieces mm

RATCHETING COMBINATION SPANNER SET RS TOOL ROLL 8 PIECES

- 72 teeth ratchet spanners giving a 5° increment between clicks
- Hip grip on the ring end, turn spanner over to change direction
- Chrome vanadium satin finish
- Supplied in a handy tool roll style wallet
- Designed and manufactured to DIN ISO 1711-1 and DIN 3113A

Ratchet Spanners:
8, 10, 11, 12, 13, 14, 17, 19 mm

Item ID: **6508RSMM**



12 Pieces mm

RATCHETING COMBINATION SPANNER SET RS TOOL ROLL 12 PIECES

- 72 teeth ratchet spanners giving a 5° increment between clicks
- Hip grip on the ring end, turn spanner over to change direction
- Chrome vanadium satin finish
- Supplied in a handy tool roll style wallet
- Designed and manufactured to DIN ISO 1711-1 and DIN 3113A

Ratchet Spanners:
8, 9, 10, 11, 12, 13, 14, 15, 16, 17, 18, 19 mm

Item ID: **6512RSMM**

NEW

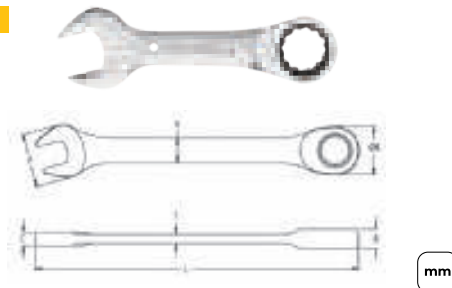

mm

STUBBY RATCHETING COMBINATION SPANNERS

- Ideal for use in confined spaces
- A ratcheting ring and open ended spanner combined with the same size at each end
- Simply turn over to reverse the direction of use when ratcheting
- TengTools hip grip design on the ring end for contact with the flat side of the fastening
- 72 teeth ratchet spanners giving a 5° increment between clicks
- Ideal for rapid tightening and loosening of fastenings
- Chrome vanadium satin finish

ITEM ID:	Size mm	L mm	A mm	B mm	C mm	D mm	H mm	T mm	Weight g
6005M10RS	10	97	22	20	4.8	7.6	9.5	3.3	36
6005M11RS	11	102	24.2	21	5.2	8	10	3.6	47
6005M12RS	12	106	25.7	23	5.5	8.5	11	3.9	49
6005M13RS	13	110	27.2	25	5.8	8.9	12	4	61
6005M14RS	14	115	30.8	27	6.2	9.3	13	4.3	75
6005M15RS	15	119	32.4	28	6.5	9.7	13.6	4.5	95
6005M16RS	16	123	34	30	6.8	10.2	14.4	4.7	105
6005M17RS	17	127	37.7	32	7.2	10.6	15.3	5	120
6005M18RS	18	132	39.3	33	7.7	11	16.2	5.2	136
6005M19RS	19	139	40.8	34	8.2	11.5	17	5.5	150

NEW



TT SERIES

10 Pieces mm

STUBBY RATCHETING SPANNER SET RS TTI

- Short stubby spanners for use in confined spaces.
- 72 teeth ratchet spanners giving a 5° increment between clicks.
- Hip Grip on the ring end, turn spanner over to change direction.
- Chrome vanadium satin finish

Stubby Ratchet Spanners:
10, 11, 12, 13, 14, 15, 16, 17, 18, 19 mm

Item ID: **TT6010MRS**



TT SERIES

8 Pieces mm

RATCHETING COMBI SPANNER SET RF TTI

- 72 teeth ratchet spanners giving a 5° increment between clicks
- Flexible head for use at an angle or for reversing the direction of use when ratcheting
- Chrome vanadium satin finish
- Removable lid and dove tail joints

Flexible head Ratchet Spanners:
8, 10, 11, 12, 13, 14, 17, 19 mm

Item ID: **TT6508RF**

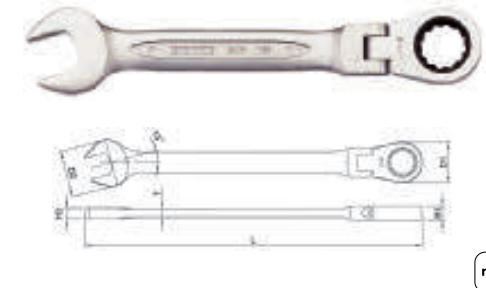

mm

FLEX-HEAD RATCHETING COMBINATION SPANNER METRIC RF

- A ratcheting ring and open ended spanner with the same size at each end
- TengTools hip grip design on the ring end for contact with the flat side of the fastening
- 72 teeth ratchet spanners giving a 5° increment between clicks
- Reversible ratchet mechanism
- Ideal for rapid tightening and loosening of fastenings
- Chrome vanadium satin finish
- Designed and manufactured to DIN ISO 1711-1 and DIN 3113A

ITEM ID:	Size mm	L mm	H1 mm	H2 mm	D1 mm	D2 mm	T mm	Weight g
600507RF	7	127	6.8	4	17	17.6	2.8	50
600508RF	8	127	6.8	4	17	17.6	2.8	50
600509RF	9	131	7.2	4.4	19	19.8	2.9	50
600510RF	10	136	7.6	4.8	20	22	3.3	60
600511RF	11	141	8	5.2	21	24.1	3.6	60
600512RF	12	147	8.5	5.5	23	25.9	3.9	80
600513RF	13	154	9	5.8	25	27.3	4	100
600514RF	14	160	9.3	6.2	27	30.6	4.3	120
600515RF	15	169	9.7	6.5	28	32.2	4.3	120
600516RF	16	179	10.2	6.8	30	33.7	4.7	160
600517RF	17	190	10.6	7.2	32	36.6	5	190
600518RF	18	203	11	7.7	33	38.4	5.2	190
600519RF	19	215	11.5	8.2	34	40.2	5.5	200



SPANNER RING

- Spanner ring with carabiner style snap hook
- Ideal for storing combination and double ring spanners
- Alternatively use as a belt hook for spanners with a ring end

Item ID: **600**

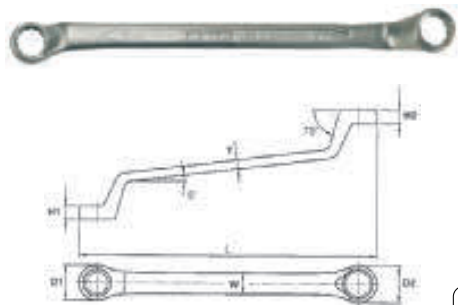

mm

DOUBLE RING SPANNER METRIC

- Different size at each end to give 2 sizes with one wrench
- Double curved heads offset at 75° for easier use on flat surfaces
- Chrome vanadium satin finish
- TengTools hip grip design for contact with the flat side of the fastening
- Designed and manufactured to DIN 838

ITEM ID:	Size mm	L mm	H1 mm	H2 mm	D1 mm	D2 mm	T mm	Weight g
630607	6x7	168	5.6	6.3	10.7	12.2	4.1	45
630809	8x9	183	6.6	7	13.6	15.1	4.5	60
631011	10x11	198	7.4	7.7	16.6	18	4.9	100
631213	12x13	217	8.1	8.4	19.5	20.9	5.4	105
631415	14x15	239	8.8	9.1	22.4	23.7	5.7	145
631617	16x17	260	9.5	9.8	25.3	26.7	6.2	195
631819	18x19	292	10.1	10.4	28.2	29.7	6.6	250
632022	20x22	318	10.9	11.4	31.1	34	7.1	320
632123	21x23	326.5	11.2	11.6	32.6	35.5	7.6	340
632427	24x27	329	12.4	13.4	36.9	41	8.1	475
633032	30x32	362	14.4	15.2	45.5	48.5	9	522

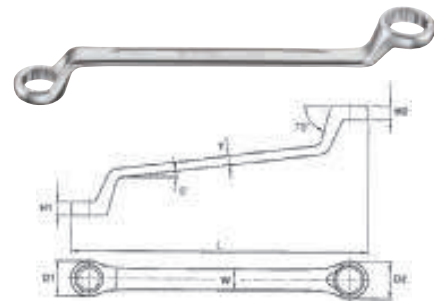

AF

DOUBLE RING SPANNER AF

- Different size at each end to give 2 sizes with one wrench
- Double curved heads offset at 75° for easier use on flat surfaces
- Chrome vanadium satin finish
- TengTools hip grip design for contact with the flat side of the fastening

ITEM ID:	Size AF	L mm	H1 mm	H2 mm	D1 mm	D2 mm	T mm	Weight g
673032	1/4 x 5/16	168	5.6	6.3	10.7	12.2	4.1	45
673436	3/8 x 7/16	198	7.4	7.7	16.6	18	4.9	93
673840	1/2 x 7/16	217	8.1	7.7	19.5	20.9	5.4	135
674244	13/16 x 7/8	318	10.9	11.4	31.1	34	7.1	325
674648	15/16 x 1-1/16	347	12.4	13.4	36.9	40.5	8.1	475
675052	1 x 1-1/8	355	12.7	13.7	38.4	42.8	8.5	570
675456	1-1/8 x 1-1/4	362	14.4	15.2	45.5	48.5	9	650



mm

DOUBLE RING SPANNER RIGGER JIGGER 10 X 13MM

- The original TengTools Rigger Jigger
- 10 x 13mm double ring spanner
- Compact, angled heads and 12 point opening at each end
- The two most commonly used sizes in one handy tool

Item ID: **601013**

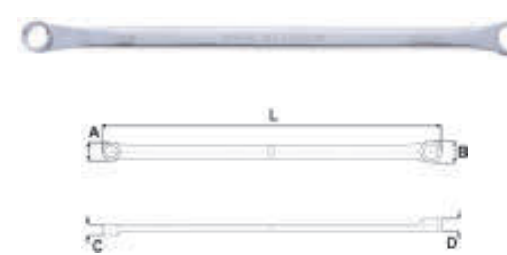

mm

LONG DOUBLE RING SPANNER METRIC

- Metric long reach double ring spanner
- Flat design for use in confined spaces
- Different size at each end to give 2 sizes with one wrench
- Chrome vanadium satin finish
- TengTools hip grip design for contact with the flat side of the fastening
- Designed and manufactured to DIN837

ITEM ID:	Size mm	L mm	A mm	B mm	C mm	D mm	Weight g
630810FL	8x10	265	12.5	15	7.5	8.4	72
631113FL	11x13	328	17.8	20.3	10.4	11.3	155
631214FL	12x14	328	17.8	20.3	10.4	11.3	157
631618FL	16x18	408	23.4	26.3	12.8	14.4	284
631719FL	17x19	407	23.7	26.6	13	14.8	284
632224FL	22x24	430	31.3	34	15.4	17.7	482



TT SERIES
x4

11 Pieces

mm

DOUBLE RING SPANNER SET TTX4 11 PIECES

- Different size at each end to give 22 sizes in total
- Double curved heads offset at 75° for easier use on flat surfaces
- Chrome vanadium satin finish
- TengTools hip grip design for contact with the flat side of the fastening
- Designed and manufactured to DIN838

Double Ring Spanners:
6x7, 8x9, 10x11, 12x13, 14x15, 16x17, 18x19, 20x22, 21x23, 24x27, 30x32 mm

Item ID: **TTX6311**



TT SERIES

x4

6 Pieces

mm

LONG DOUBLE RING SPANNER SET TTX4

- Different size at each end to give 12 sizes in total
- Extra long, flat design for extra torque
- Chrome vanadium satin finish
- TengTools hip grip design for contact with the flat side of the fastening
- Designed and manufactured to DIN837

Extra long Double Ring Spanners:
8x10, 11x13, 12x14, 16x18, 17x19, 22x24 mm

Item ID: **TTXFLS06**



TT SERIES

x4

7 Pieces

AF

DOUBLE RING SPANNER SET AF TTX4 7 PIECES

- Different size at each end to give 12 sizes in total
- Double curved heads offset at 75° for easier use on flat surfaces
- Chrome vanadium satin finish
- TengTools hip grip design for contact with the flat side of the fastening

Double Ring Spanners:
1/4" x 5/16", 3/8" x 7/16", 7/16" x 1/2", 13/16" x 7/8", 15/16" x 1-1/16", 1" x 1-1/8", 1-1/8" x 1-1/4"

Item ID: **TTX6707**



FOAM SERIES

x4

8 Pieces mm

DOUBLE RING SPANNER SET FOAMX4 8 PIECES

- Different size at each end to give 16 sizes in total
- Double curved heads offset at 75° for easier use on flat surfaces
- Chrome vanadium satin finish
- TengTools hip grip design for contact with the flat side of the fastening
- Tools are held in place using three colour pre-cut EVA foam
- Designed and manufactured to DIN838

Double Ring Spanners:

6x7, 8x9, 10x11, 12x13, 14x15, 16x17, 18x19, 20x22 mm

Item ID: **TEX6308**



FOAM SERIES

x4

6 Pieces mm

LONG DOUBLE RING SPANNER SET FOAMX4

- Different size at each end to give 12 sizes in total
- Extra long, flat design for extra torque
- Chrome vanadium satin finish
- TengTools hip grip design for contact with the flat side of the fastening
- Tools are held in place using three colour pre-cut EVA foam
- Designed and manufactured to DIN837

Extra long Double Ring Spanners:

8x10, 11x13, 12x14, 16x18, 17x19, 22x24 mm

Item ID: **TEXFLS06**



5 Pieces mm

LONG DOUBLE RING SPANNER WALL RACK

- Different size at each end to give 10 sizes in total
- Extra long, flat design for extra torque and easier access
- Chrome vanadium satin finish
- TengTools hip grip design for contact with the flat side of the fastening
- Supplied with a wall rack for fixing to the wall or a workbench

Extra long Double Ring Spanners:

8x10, 11x13, 12x14, 17x19, 22x24 mm

Item ID: **WRFLS05**



8 Pieces mm

DOUBLE RING SPANNER SET 8 PIECES

- Different size at each end to give 16 sizes in total
- Double curved heads offset at 75° for easier use on flat surfaces
- Chrome vanadium satin finish
- TengTools hip grip design for contact with the flat side of the fastening
- Designed and manufactured to DIN 838

Double Ring Spanners:

6x7, 8x9, 10x11, 12x13, 14x15, 16x17, 18x19, 20x22 mm

Item ID: **6308**



11 Pieces mm

DOUBLE RING SPANNER SET 11 PIECES

- Different size at each end to give 22 sizes in total
- Double curved heads offset at 75° for easier use on flat surfaces
- Chrome vanadium satin finish
- TengTools hip grip design for contact with the flat side of the fastening
- Designed and manufactured to DIN 838

Double Ring Spanners:

6x7, 8x9, 10x11, 12x13, 14x15, 16x17, 18x19, 20x22, 21x23, 24x27, 30x32 mm

Item ID: **6311**



8 Pieces mm

DOUBLE RING SPANNER SET TOOL ROLL 8 PIECES

- Different size at each end to give 16 sizes in total
- Double curved heads offset at 75° for easier use on flat surfaces
- Chrome vanadium satin finish
- TengTools hip grip design for contact with the flat side of the fastening
- Supplied in a handy tool roll style wallet
- Designed and manufactured to DIN 838

Double Ring Spanners:

6x7, 8x9, 10x11, 12x13, 14x15, 16x17, 18x19, 20x22 mm

Item ID: **6308MM**



7 Pieces AF

DOUBLE RING SPANNER SET AF TOOL ROLL 7 PIECES

- Different size at each end to give 22 sizes in total
- Double curved heads offset at 75° for easier use on flat surfaces
- Chrome vanadium satin finish
- TengTools hip grip design for contact with the flat side of the fastening
- Designed and manufactured to DIN838

Double Ring Spanners:

1/4"x5/16", 3/8"x7/16", 7/16"x1/2", 13/16"x7/8", 15/16"x1-1/16", 1"x1-1/8", 1-1/8"x1-1/4"

Item ID: **6707AF**

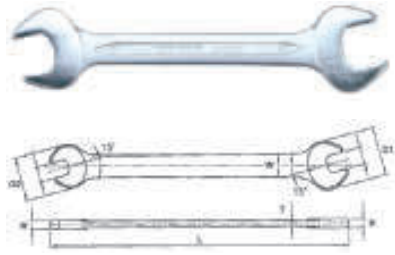

mm

DOUBLE OPEN ENDED SPANNER METRIC

- Different size at each end to give 2 sizes with one wrench
- Open at each end off set at 15° for easier use
- Chrome vanadium satin finish
- Designed and manufactured to DIN3110

ITEM ID:	Size mm	L mm	H mm	D1 mm	D2 mm	T mm	Weight g
620607	6x7	123	3.7	18	15.5	3.7	25
620809	8x9	140	4	22.7	20.4	4	35
621011	10x11	156	5	27.1	24.9	5	50
621213	12x13	172	5.5	31.2	29.2	5.5	75
621415	14x15	188.5	5.9	35.3	33.3	5.9	105
621617	16x17	204	6.3	38.9	37.1	6.3	155
621819	18x19	221	6.7	42.8	40.9	6.7	190
622022	20x22	237	7.1	48.8	44.8	7.1	220
622123	21x23	247	7.7	50.8	46.8	7.7	245
622427	24x27	263	8.1	59.1	52.8	8.1	305
623032	30x32	298	9	69.8	65.4	9	465



TT SERIES
8 Pieces

mm

DOUBLE OPEN ENDED SPANNER SET TTI

- Different size at each end to give 16 sizes in total
- Open at each end off set at 15° for easier use
- Chrome vanadium satin finish
- Designed and manufactured to DIN3110

Double Open Ended Spanners:
6x7, 8x9, 10x11, 12x13, 14x15, 16x17, 18x19, 20x22 mm

Item ID: **TT6208**

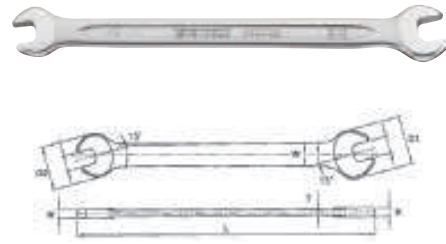

AF

DOUBLE OPEN ENDED SPANNER AF

- Different size at each end to give 2 sizes with one wrench
- Open at each end off set at 15° for easier use
- Chrome vanadium satin finish
- Designed and manufactured to ASME B107.100

ITEM ID:	Size AF	L mm	H mm	D1 mm	D2 mm	T mm	Weight g
663032	1/4 x 5/16	123	2.9	15.5	18	2.9	25
663436	3/8 x 7/16	156	3.4	24.9	27.1	3.4	61
663840	1/2 x 9/16	180	4	31.3	33.3	4	85
664244	5/8 x 3/4	221	4.6	37.1	42.8	4.6	160
664648	13/16 x 7/8	237	4.9	44.8	48.8	4.9	220
665052	15/16 x 1	255	5.3	50.8	56.8	5.3	298
665456	1-1/8 x 1-1/4	298	6	65.4	69.8	6	470



TT SERIES
7 Pieces

AF

DOUBLE OPEN ENDED SPANNER SET AF TTX4

- Different size at each end to give 14 sizes in total
- Chrome vanadium satin finish
- TengTools hip grip design for contact with the flat side of the fastening
- Designed and manufactured to ASME B107.100

Double Open Ended Spanners:
1/4" x 5/16", 3/8" x 7/16", 1/2" x 9/16", 5/8" x 3/4",
13/16" x 7/8", 15/16" x 1", 1-1/8" x 1-1/4"

Item ID: **TTX6607**



8 Pieces

mm

DOUBLE OPEN ENDED SPANNER SET 8 PIECES

- Different size at each end to give 16 sizes in total
- Open at each end off set at 15° for easier use
- Chrome vanadium satin finish
- Designed and manufactured to DIN3110 and DIN3113A

Double Open Ended Spanners:
6x7, 8x9, 10x11, 12x13, 14x15, 16x17, 18x19, 20x22 mm

Item ID: **6208**



11 Pieces

mm

DOUBLE OPEN ENDED SPANNER SET 11 PIECES

- Different size at each end to give 22 sizes in total
- Open at each end off set at 15° for easier use
- Chrome vanadium satin finish
- Designed and manufactured to DIN3110

Double Open Ended Spanners:
6x7, 8x9, 10x11, 12x13, 14x15, 16x17, 18x19, 20x22, 21x23, 24x27, 30x32 mm

Item ID: **6211**



11 Pieces

mm

DOUBLE OPEN ENDED SPANNER SET TOOL ROLL 11 PIECES

- Different size at each end to give 22 sizes in total
- Open at each end off set at 15° for easier use
- Chrome vanadium satin finish
- Supplied in a handy tool roll style wallet
- Designed and manufactured to DIN3110 and DIN3113A

Double Open Ended Spanners:
6x7, 8x9, 10x11, 12x13, 14x15, 16x17, 18x19, 20x22, 21x23, 24x27, 30x32 mm

Item ID: **6211MM**



7 Pieces

AF

DOUBLE OPEN ENDED SPANNER SET AF TOOL ROLL 7 PIECES

- Different size at each end to give 14 sizes in total
- Chrome vanadium satin finish
- TengTools hip grip design for contact with the flat side of the fastening
- Designed and manufactured to ASME B107.100

Double Open Ended Spanners:
1/4" x 5/16", 3/8" x 7/16", 1/2" x 9/16", 5/8" x 3/4", 13/16" x 7/8",
15/16" x 1", 1-1/8" x 1-1/4"

Item ID: **6607AF**

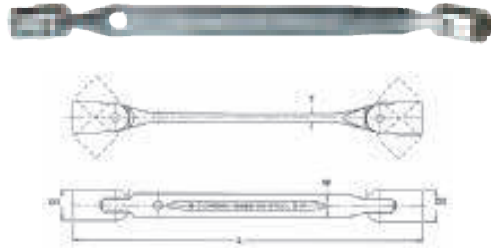

mm

DOUBLE FLEX WRENCH METRIC

- Swivel end wrench for fast pre-tightening and loosening
- 12 point socket at each end with 2 different sizes in one wrench
- Angle at 90° for added torque when applying the final tightening
- Extra torque for loosening stubborn fastenings
- Chrome vanadium satin finish
- Designed and manufactured to DIN standards

ITEM ID:	Size mm	L mm	D1 mm	D2 mm	W mm	T mm	Weight g
650809	8x9	192	12.2	13.5	10	4.6	95
651011	10x11	200	15.5	16.9	10	4.6	105
651013	10x13	213	14.5	18.2	12.5	5	140
651213	12x13	218	18.2	19.2	12.5	5	150
651415	14x15	243	20.5	21.7	14	5.8	215
651617	16x17	275	23	24.2	15	6.5	300
651819	18x19	284	25.5	26.7	16	7.5	382

AF

DOUBLE FLEX WRENCH AF

ITEM ID:	Size AF	L mm	D1 mm	D2 mm	W mm	T mm	Weight g
611214	3/8"x7/16"	200	15.5	16.9	10	4.6	105
611618	1/2"x9/16"	218	18.2	19.2	12.5	5	150
612022	5/8"x11/16"	275	23	24.2	14	6.5	300



TT SERIES
1

6 Pieces mm

DOUBLE FLEX WRENCH SET TTI 6 PIECES

- Swivel end wrenches for fast pre-tightening and loosening
- Angle at 90° for added torque when applying the final tightening
- Extra torque for loosening stubborn fastenings
- Chrome vanadium satin finish
- Designed and manufactured to DIN standard

Double Flex Wrenches
8x9, 10x11, 12x13, 14x15, 16x17, 18x19 mm

Item ID: **TT6506**



FOAM SERIES
2

7 Pieces mm

DOUBLE FLEX WRENCH SET FOAM2 7 PIECES

- Swivel end wrenches for fast pre-tightening and loosening
- Angle at 90° for added torque when applying the final tightening
- Extra torque for loosening stubborn fastenings
- Tools are held in place using three colour pre-cut EVA foam
- Designed and manufactured to DIN standard

Double Flex Wrenches
8x9, 10x11, 12x13, 14x15, 16x17, 18x19 mm

B-flex Wrench:
1/4" Male x 1/4" Hex Female

Item ID: **TEDDF7**



6 Pieces mm

DOUBLE FLEX WRENCH SET WALL RACK

- Swivel end wrenches for fast pre-tightening and loosening
- Angle at 90° for added torque when applying the final tightening
- Extra torque for loosening stubborn fastenings
- Chrome vanadium satin finish
- Supplied with a wall rack for fixing to the wall or a workbench

Double Flex Wrenches
8x9, 10x11, 12x13, 14x15, 16x17, 18x19 mm

Item ID: **WRDF06**

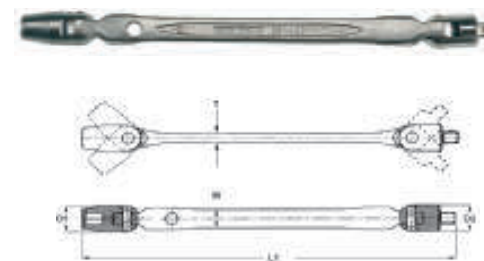

BI-FLEX WRENCH

- Swivel end wrench for fast pre-tightening and loosening
- 1/4" bit socket at one end to suit screwdriver bits
- 1/4" male drive on the other end to suit 1/4" drive sockets
- Angle at 90° for added torque
- Chrome vanadium satin finish
- Designed and manufactured to DIN standard

ITEM ID:	Sizes	L mm	D1 mm	D2 mm	W mm	T mm	Weight g
691406	1/4" Hex x 1/4" M	196	14.5	14.5	10	4.6	102



mm

FLARE NUT WRENCH METRIC

- Opening designed to allow use over pipes when tightening flare nuts
- Ideal for use on hydraulic systems on vehicles
- Also suitable for use on water pipe connections
- Different size at each end to give 2 sizes with one wrench
- Open at each end off set at 15° for easier use
- Chrome vanadium satin finish
- Designed and manufactured to DIN 3118

ITEM ID:	Sizes mm	L mm	H mm	D1 mm	D2 mm	C1 mm	C2 mm	T mm	Weight g
641011	10x11	152.4	7.9	21.4	23	7	8.2	4.3	60
641213	12x13	178.6	10	25	27.4	9	10.3	5.7	113
641314	13x14	178.6	13.1	25	27.4	14.3	15.1	5.7	113
641617	16x17	196	15.1	29.9	31.9	15.4	17	6.4	113
641922	19x22	207.7	17	34.2	38.2	18.9	20	7.4	113

AF

FLARE NUT WRENCH AF

ITEM ID:	Sizes mm	L mm	H mm	D1 mm	D2 mm	C1 mm	C2 mm	T mm	Weight g
661416	7/16"x1/2"	158.8	11.9	23	24.3	8.2	9	5.5	113



mm

RATCHETING MULTI DRIVE RING SPANNER

- Two size openings at each end
- 4 different spanner sizes in one handy tool
- TengTools hip grip design on the ring end for contact with the flat side of the fastening
- 72 teeth ratchet spanners giving a 5° increment between clicks
- Reversible ratchet mechanism with a flip reverse lever at each end
- Ideal for rapid tightening and loosening of fastenings
- Chrome vanadium satin finish

ITEM ID:	Sizes mm	L mm	D1 mm	D2 mm	Weight g
60050811RX	8, 9, 10, 11	150	19.2	22	13.5
60051215RX	12, 13, 14, 15	190	25.5	28	18.4
60051619RX	16, 17, 18, 19	320	31.7	34	20.8



3 Pieces mm

RATCHETING MULTI DRIVE RING SPANNER SET 3 PIECES

- Two size openings at each end
- 4 different spanner sizes in one handy tool
- TengTools hip grip design on the ring end for contact with the flat side of the fastening
- 72 teeth ratchet spanners giving a 5° increment between clicks
- Reversible ratchet mechanism with a flip reverse lever at each end
- Ideal for rapid tightening and loosening of fastenings
- Chrome vanadium satin finish
- Supplied in a wallet bag

Multidrive Ring Spanners:
8x9x10x11, 12x13x14x15, 16x17x18x19 mm

Item ID: **6503RX**

MULTI DRIVE RING SPANNER SERVICE KITS

- Replacement ratchet heads for the Ratcheting Multi Drive Ring Spanners

ITEM ID:	Service Kit For:	Size:
60050809RXRK	60050811RX	8x9
60051011RXRK	60050811RX	10x11
60051213RXRK	60051215RX	12x13
60051415RXRK	60051215RX	14x15
60051617RXRK	60051619RX	16x17
60051819RXRK	60051819RX	18x19

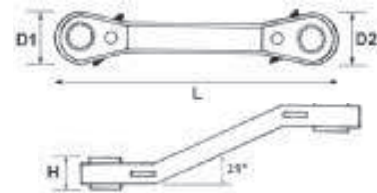

RATCHETING OFFSET RING SPANNER METRIC

- Fibre reinforced reversible ratchet wrench
- 18 teeth for extra strength and use in outdoor sites
- Double ended with 25° offset heads
- 6mm has a 6 point ring end while other sizes have 12 point ring ends
- Chrome vanadium satin finish with FRP body

ITEM ID:	Sizes mm	L mm	H mm	D1 mm	D2 mm	Weight g
680608	6x8	112	8	20	20	63
680709	7x9	133	8.4	21	23	81
681013	10x13	163	10.2	26	30	149
681214	12x14	172	10.2	30	32	169
681719	17x19	203	11	37	40	254
682122	21x22	235	11.4	41	45	290



TT SERIES
1

6 Pieces mm

RATCHETING RING SPANNER SET TTI 6 PIECES

- Fibre reinforced reversible ratchet wrenches
- 18 teeth for extra strength and use in outdoor sites
- Double ended with 25° offset heads
- 12 point ring ends (6x8mm is 6 point)
- Chrome vanadium satin finish with FRP bodies

RORS Wrenches:
6x8, 7x9, 10x13, 12x14, 17x19, 21x22 mm

Item ID: **TTRORS**

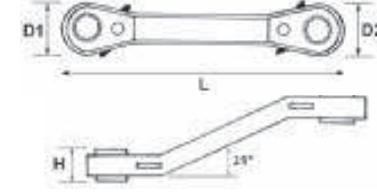

RATCHETING OFFSET TX-E RING SPANNER

- Fibre reinforced reversible ratchet wrench
- 18 teeth for extra strength and use in outdoor sites
- Double ended with 25° offset heads
- For use with external TX fastenings
- Chrome vanadium satin finish with FRP body

ITEM ID:	Sizes	L mm	H mm	D1 mm	D2 mm	Weight g
680810E	E8xE10	133	8.2	21	23	84
681112E	E11xE12	140	8.2	23	26	95
681416E	E14xE16	172	10.2	30	32	174
681820E	E18xE20	203	11.5	37	40	280
682224E	E22xE24	235	11.5	41	44	330

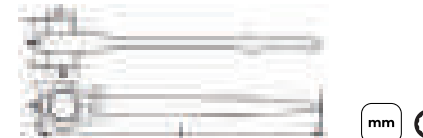

RATCHETING CONSTRUCTION WRENCH

- For use in construction
- Ideal for scaffolding, pallet racking, shelving systems and metal panel erection
- 2 sizes in one with 12 point double ended sockets
- 32 teeth for extra strength and use in outdoor sites
- Flip reverse for quickly changing between tightening and loosening
- Tapered podger style handle for aligning holes prior to fixing
- Hole in the handle for use with a fall protection wire

ITEM ID:	Sizes mm	L mm	A mm	B mm	C mm	D mm	Weight g
PCW1719	17 x 19	315	42	50	26	26.3	450
PCW1922	19 x 22	315	42	50	26	29.5	450
PCW1924	19 X 24	315	42	50	26	32	469
PCW2124	21 x 24	315	42	50	28	32	462
PCW2430	24 X 30	450	63	63	32	40	1332
PCW2730	27 x 30	366	65	63	36.6	40	1350

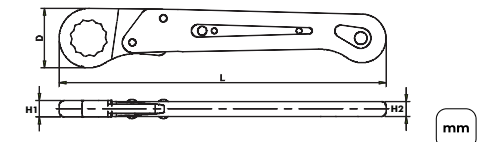

QUICK WRENCH

- Special design for loosening and tightening pipe and hose couplings
- Ideal for use in confined spaces
- Ring end opens up easily to access the nut on the coupling

ITEM ID:	Size mm	L mm	D mm	H1 mm	H2 mm	Weight g
600813	13	141	27.5	7.2	8	92
600814	14	191	35.7	10	9	165
600816	16	191	35.7	10	9	165
600817	17	191	35.7	10	9	180
600819	19	191	35.7	10	9	225
600822	22	233	40.7	13	12	294
600824	24	235	43.2	13	12	300
600827	27	325	54.2	14.1	14.4	625
600830	30	325	56.4	15.9	14.4	610
600832	32	325	58.5	15.9	14.4	625



TT SERIES
x4

7 Pieces mm

QUICK WRENCH SET TTX4 7 PIECES

- Special design for loosening and tightening pipe and hose couplings
- Ideal for use in confined spaces
- Ring end has a clever design so that it opens up easily to access the nut on the coupling

Quick Wrenches:
13, 17, 19, 22, 24, 27, 32 mm

Item ID: **TTXQRS07**



HOOK WRENCH

- Suitable for use with locking nuts and bearing carriers
- Chrome vanadium satin finish
- Designed to fit locking nuts according to DIN 1804
- Designed and manufactured to DIN 1810

ITEM ID:	Capacity mm	Capacity AF	Length mm	Length AF	Weight g
HP101	19 to 50	3/4" to 2"	145	5-3/4"	122
HP102	32 to 75	1-1/4" to 3"	178	7"	234
HP103	50 to 120	2" to 4-3/4"	247	9-3/4"	447



PIN WRENCH

- Suitable for use with locking nuts and bearing carriers
- Chrome vanadium satin finish
- Designed to fit locking nuts according to DIN 1816
- Designed and manufactured to DIN 1810

ITEM ID:	Pin Size mm	Capacity mm	Length mm	Length AF	Weight g
HP2014	4	19 to 50	145	5-3/4"	122
HP2015	5	19 to 50	145	5-3/4"	122
HP2025	5	32 to 75	178	7"	227
HP2026	6	32 to 75	178	7"	227
HP2036	6	50 to 120	247	9-3/4"	451
HP2038	8	50 to 120	247	9-3/4"	451

SPARE PARTS FOR HOOK AND PIN WRENCHES

- Replacement pins for TengTools pin wrenches

ITEM ID:	Suitable For:
HP2014-P	HP2014 pin wrench
HP2015-P	HP2015 & HP2025 pin wrenches
HP2026-P	HP2026 pin wrench
HP2036-P	HP2036 pin wrench
HP2038-P	HP2038 pin wrench



HOOK & PIN WRENCH SET TT1 8 PIECES

- Includes a range of handles, pin and hook adaptors
- Chrome vanadium satin finish
- To be used for nuts designed and manufactured to DIN1804 & 1816
- Wrench manufactured to DIN1810

Hook & Pin Wrenches	
Hook Handles:	3/4" to 2", 1-1/4" to 3", 2" to 4-3/4"
Pin Adaptors:	4, 5, 6 mm
Pins:	6, 8 mm

Item ID: **TTHP08**



ADJUSTABLE WRENCH ALLIGATOR

- 8" (200mm) adjustable wrench
- Integral measurement scale on the jaw
- Moving jaw does not protrude allowing use in confined spaces
- Incorporates an "alligator" style pipe grip for gripping round objects
- Hole in the handle for tool securing when working at height
- High grade chrome vanadium steel with a black phosphate finish
- Designed and manufactured to: ISO 6787

Item ID: **4003J**

ADJUSTABLE WRENCH ALLIGATOR SERVICE KIT

- Service kit for 4003J adjustable wrench
- Includes replacement pin, knurl and spring

ITEM ID:

4003JRK

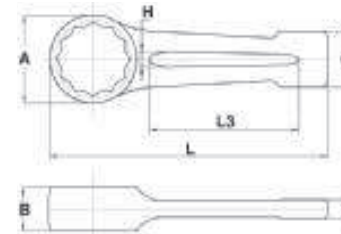

mm

RING END SLOGGING WRENCH METRIC

- Designed for extra heavy duty work
- For use with a hammer or sledge hammer
- Manufactured in impact resistant Chrome molybdenum
- Designed and manufactured to DIN 7444

ITEM ID:	Size mm	L mm	A mm	B mm	C mm	D mm	L3 mm	H mm	Weight g
903024	24	162	42.8	14.7	24.6	7.9	93.9	9.4	248
903027	27	180	45.2	15.4	25	8.6	107.3	9.4	260
903030	30	190	50.6	16.2	29.4	9.3	107.3	11.5	376
903032	32	190	53.7	16.4	31.7	10	107.3	12.3	480
903036	36	205	58.3	17.9	35.6	10.5	107.3	13.3	520
903038	38	229	63.7	19.9	36.9	12	130.3	13.3	660
903041	41	230	63.9	19.9	37.4	12.3	130.3	13.3	780
903046	46	240	73.5	21.8	43.9	12.5	130.9	14.5	1150
903050	50	255	78.5	23.2	46.3	13	134.5	17	1070
903055	55	266	85.1	25	49.4	15.5	141.2	19.3	1350
903060	60	280	91.7	26.5	52.2	16.5	150	22.7	1650
903065	65	298	100	27.5	54	16.5	150	23.2	1890
903070	70	330	109.5	32.8	62	20	165	24.6	2850
903075	75	330	110	32.8	62.2	20	154	24.6	2700
903080	80	355	129.4	37	82.3	23.8	170	40	3400
903085	85	355	129.5	37.3	82	23.4	170	40	4100
903090	90	395	143.5	40	72.7	24.2	170	47.5	5200
903095	95	390	144	37.1	72.8	20.8	165	47.5	5100
903100	100	420	155	41.6	80	23.6	175	50	6700

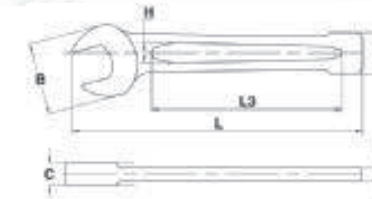

mm

OPEN END SLOGGING WRENCH METRIC

- Designed for extra heavy duty work
- For use with a hammer or sledge hammer
- Manufactured in impact resistant Chrome molybdenum
- Designed and manufactured to DIN 133

ITEM ID:	Size mm	L mm	A mm	B mm	C mm	D mm	L3 mm	H mm	Weight g
902024	24	178	52.3	14.5	23.4	7.8	107.5	10.2	250
902027	27	180	55	15.5	25.2	8.6	107.5	10.2	350
902030	30	190	60.4	16.2	30	9.5	107.5	15.6	500
902032	32	190	60.5	16.7	30.5	9.8	108	14.8	480
902036	36	214	71.3	17	35	9.8	118	14.9	700
902038	38	215	72	17.3	37	9.8	118	16.2	750
902041	41	233	82.4	19.2	39.3	12	127.6	18.3	900
902046	46	252	93.2	20.4	44.2	12.8	135.6	18.8	1300
902050	50	275	104	21.3	48	13.2	140.8	19.6	1500
902055	55	295	114.4	23.8	54.2	15.3	158.6	24.2	1950
902060	60	315	125.1	26.6	58.8	17.3	166.2	24.8	2500
902065	65	340	138	28.8	55	17.6	175	25.1	3300
902070	70	370	152.7	30.6	69	19	190	32	4300
902075	75	370	152.7	31	69	19	190	33.4	4700
902080	80	397	175	33.2	71.5	19	180	46.6	5500
902085	85	397	175	33.2	71.5	19	180	46.6	5200
902090	90	444	191	34.7	80	19.6	190	51.7	7000
902095	95	444	191.3	36.3	80	21	190	52.2	6600
902100	100	488	225	42.3	85	21.8	205	55.5	10500



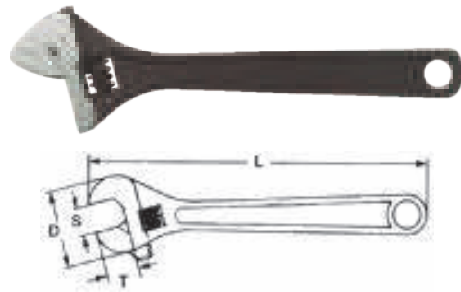

ADJUSTABLE WRENCH

- Integral measurement scale on the jaw
- Moving jaw does not protrude allowing use in confined spaces
- Hole in the handle for tool securing when working at height
- High grade chrome vanadium steel with a black phosphate finish
- Designed and manufactured to ISO 6787

ITEM ID:	L		Capacity		T	D	ISO	Weight
	mm	AF	mm	AF				
4001	100	4"	17	11/16"	14	31	33	50
4002	150	6"	24	15/16"	19	44	85	140
4003	200	8"	28	1-1/8"	26	57	180	260
4004	250	10"	33	1-1/4"	31	68	320	440
4005	300	12"	38	1-1/2"	32	80	515	660
4006	375	15"	50	1-5/16"	44	100	920	1200
4007	450	18"	60	2-3/8"	53	122	1370	2000
4008	600	24"	70	2-3/4"	62	144	-	3700

ADJUSTABLE WRENCH SERVICE KITS

- Includes replacement pin, knurl and spring

ITEM ID:	Suitable For:
4001RK	4" adjustable wrench - 4001
4002RK	6" adjustable wrench - 4002
4003RK	8" adjustable wrench - 4003
4004RK	10" adjustable wrench - 4004
4005RK	12" adjustable wrench - 4005
4006RK	15" adjustable wrench - 4006
4007RK	18" adjustable wrench - 4007
4008RK	24" adjustable wrench - 4008

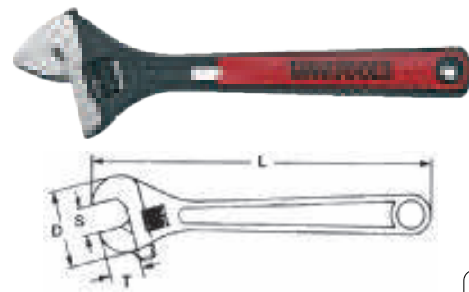

TPR GRIP

ADJUSTABLE WRENCH TPR GRIP

- Integral measurement scale on the jaw
- Moving jaw does not protrude allowing use in confined spaces
- Bi-material handle for extra comfort
- Hole in the handle for tool securing when working at height
- High grade chrome vanadium steel with a black phosphate finish
- Designed and manufactured to: DIN 3117 and ISO 6787

ITEM ID:	L		Capacity		T	D	ISO	Weight
	mm	AF	mm	AF				
4002IQ	157	6"	24	15/16"	20	52	85	140
4003IQ	206	8"	28	1-1/8"	25.3	62	180	260
4004IQ	255	10"	33	1-1/4"	29.5	72	320	440
4005IQ	305	12"	38	1-1/2"	32.2	83	515	660
4006IQ	380	15"	50	1-15/16"	44.7	108	920	1200

ADJUSTABLE WRENCH TPR GRIP SERVICE KITS

- Includes replacement pin, knurl and spring

ITEM ID:	Suitable For:
4002IQRK	6" adjustable wrench - 4002IQ
4003IQRK	8" adjustable wrench - 4003IQ
4004IQRK	10" adjustable wrench - 4004IQ
4005IQRK	12" adjustable wrench - 4005IQ
4006IQRK	15" adjustable wrench - 4006IQ

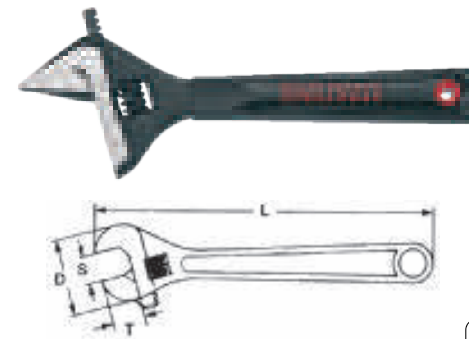

TPR GRIP

ADJUSTABLE WRENCH WIDE JAW

- Integral measurement scale
- Extra wide jaw opening increases the bolt sizes that can be worked on
- Moving jaw does not protrude allowing use in confined spaces
- Bi-material handle for extra comfort
- Hole in the handle for tool securing when working at height
- High grade chrome vanadium steel with a black phosphate finish
- Designed and manufactured to: DIN 3117 and ISO 6787

ITEM ID:	L		Capacity		T	D	Weight
	mm	AF	mm	AF			
4002WT	172	7"	34	1-3/8"	30	63.5	185
4003WT	221	8"	38	1-1/2"	34.1	72.1	260
4004WT	275	10"	50	2"	41	92.1	440
4005WT	317	12"	60	2-3/8"	55.7	110.5	660

ADJUSTABLE WRENCH WIDE JAW SERVICE KITS

- Includes replacement pin, knurl and spring

ITEM ID:	Suitable For:
4002WTRK	6" adjustable wrench - 4002WT
4003WTRK	8" adjustable wrench - 4003WT
4004WTRK	10" adjustable wrench - 4004WT
4005WTRK	12" adjustable wrench - 4005WT



TT SERIES

1

4 Pieces

mm

TPR GRIP

ADJUSTABLE WRENCH SET TTI 4 PIECES

- Includes an 8" wide jaw adjustable wrench for added versatility
- Designed and manufactured to ISO6787

Adjustable Wrenches	
6" (150 mm)	Capacity: 24 mm
8" (200 mm)	Capacity: 28 mm
10" (250 mm)	Capacity: 33 mm
8" (200 mm) Wide Jaw	Capacity: 38 mm

Item ID: TTADJ04



FOAM SERIES

2

4 Pieces

TPR GRIP

ADJUSTABLE WRENCH SET FOAM2 4 PIECES

- Includes regular style 6, 8 and 10" adjustable wrenches
- Also includes an 8" wide jaw adjustable wrench for added versatility
- Tools are held in place using three colour pre-cut EVA foam
- Designed and manufactured to DIN3117 and ISO6787

Adjustable Wrenches	
6" (150 mm)	Capacity: 24 mm
8" (200 mm)	Capacity: 28 mm
10" (250 mm)	Capacity: 33 mm
8" (200 mm) Wide Jaw	Capacity: 38 mm

Item ID: TEDADJ4

SCREWDRIVERS

MORE COMFORT MORE POWER

Unlike other brands the TengTools screwdriver blade has steel alloy wings that the plastic handle is moulded around. This allows for greater torque to be put on the screwdriver, ensures the blade is dead straight and stops the blade from moving in the handle.



Size and tip marked at the bottom of each handle for easy identification

Hole in the handle can be used in a fall arrest system, for storage and for use as a T-handle

The bi-material handle is designed for increased comfort and smooth action preventing blisters after continuous use. It gives better support and increased power transfer.

The soft black material prevents the screwdriver from sticking in the hand allowing for rapid movement

The red resistant plastic is used for the core and ensures the blade is held securely

Size marked on shaft for identification while in use

Shaft made from TengTools TT-MV PLUS steel alloy for greater strength and material flexibility

Magnetic tip designed to maximise torque transfer and reduce wear

Designed and manufactured to DIN and ISO industrial standards



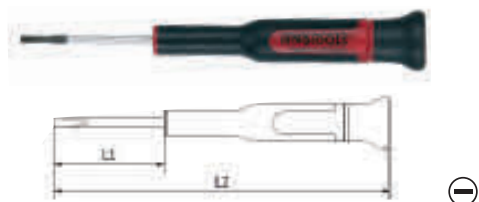

FLAT MINI SCREWDRIVER

- CrMo steel alloy for greater strength
- Rotating end piece for easier use when "transporting" the fastening

ITEM ID:	Shaft	Tip	L1 mm	L2 mm	Weight g	
MDM713	2	Round	Parallel	40	122	12
MDM714	2.4	Round	Parallel	40	122	12
MDM715	3	Round	Parallel	40	122	12

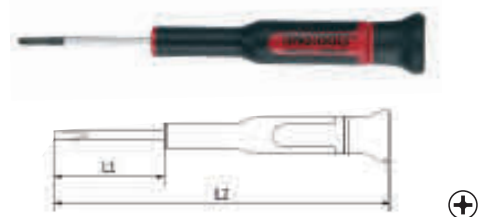

PH MINI SCREWDRIVER

- CrMo steel alloy for greater strength
- Rotating end piece for easier use when "transporting" the fastening

ITEM ID:	Shaft	Tip	L1 mm	L2 mm	Weight g	
MDM716	PH00	Round	Phillips	40	122	12
MDM717	PH0	Round	Phillips	40	122	12
MDM718	PH1	Round	Phillips	40	122	12

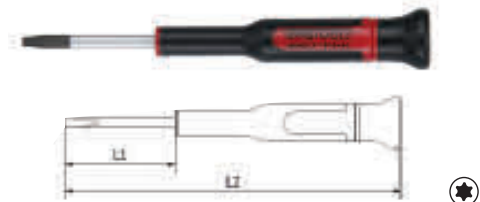

TX MINI SCREWDRIVER

- CrMo steel alloy for greater strength
- Rotating end piece for easier use when "transporting" the fastening

ITEM ID:	Shaft	Tip	L1 mm	L2 mm	Weight g	
MDM806	TX6	Round	TX	40	122	12
MDM807	TX7	Round	TX	40	122	12
MDM808	TX8	Round	TX	40	122	12
MDM809	TX9	Round	TX	40	122	12
MDM810	TX10	Round	TX	40	122	12
MDM815	TX15	Round	TX	40	122	12

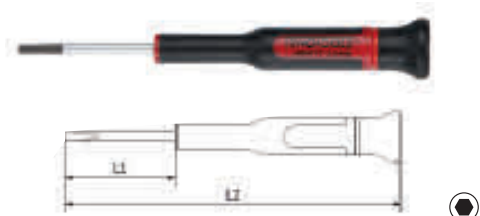

HEX MINI SCREWDRIVER

- CrMo steel alloy for greater strength
- Rotating end piece for easier use when "transporting" the fastening

ITEM ID:	Shaft	Tip	L1 mm	L2 mm	Weight g	
MDM711	2	Round	Hex	40	122	12
MDM712	2.5	Round	Hex	40	122	12



TT SERIES

16 Pieces

MINI PLIERS & SCREWDRIVER SET TTI 16 PIECES

- Mini screwdrivers feature a rotating end piece for easier use when "transporting" the fastening
- Mini pliers feature high carbon steel construction and vinyl grip handles

Mini Screwdrivers:

mm:	2.0 x 40	2.4 x 40	3.0 x 40
mm:	PH00 x 40	PH0 x 40	PH1 x 40
mm:	TX6 x 40	TX7 x 40	TX8 x 40
	TX9 x 40	TX10 x 40	TX15 x 40

Mini Pliers:

4 1/2"	SIDE CUTTER
4 1/2"	END CUTTER
5"	LONG NOSE PLIER
5"	FLAT NOSE PLIER

Item ID: TTM116



6 Pieces

MINI SCREWDRIVER SET FLAT & PH 6 PIECES

- CrMo steel alloy for greater strength
- Rotating end piece for easier use when "transporting" the fastening
- Supplied in a handy holder that can be wall mounted or used as a stand

Mini Screwdrivers:

mm:	2.0x40	2.4x40	3.0x40
mm:	PH00x40	PH0x40	PH1x40

Item ID: MDM706



6 Pieces

MINI SCREWDRIVER SET TX 6 PIECES

- CrMo steel alloy for greater strength
- Rotating end piece for easier use when "transporting" the fastening
- Supplied in a handy holder that can be wall mounted or used as a stand

Mini Screwdrivers:

mm:	TX6 x 40	TX7 x 40	TX8 x 40
	TX9 x 40	TX10 x 40	TX15 x 40

Item ID: MDM706TX



MINI SCREWDRIVER HANDLE

- Mini screwdriver handle
- For use with double ended mini screwdriver blades
- Twist grip tightening function allows the blade to be set at different lengths, ideal for where access is restricted
- Rotating end piece for easier use when "transporting" the fastening

ITEM ID:	TIP1	SIZE1	TIP2	SIZE2
MDM700	MINI SCREWDRIVER BLADE HANDLE			
2912512	+	PH00	-	2
2912513	+	PH0	-	3
2912514	+	PH1	-	4
2912520	+	P20	+	P21
2912535	+	TX5	+	TX7
2912537	+	TX6	+	TX8
2912539	+	TX9	+	TX10



8 Pieces

MINI SCREWDRIVER SET MIXED 8 PIECES

- Includes fully interchangeable double ended blades
- Sizes clearly marked on the shaft
- Hexagon shaft
- Twist grip tightening function allows the blade to be set at different lengths, ideal for where access is restricted
- Rotating end piece for easier use when "transporting" the fastening

Mini Screwdriver blade handle			
Screwdrivers Blades:			
+	-	mm:	PH00 - 2.0 PH0 - 3.0 PH1 - 4.0
+			PZ0 - PZ1
+			TX5 - TX7 TX6 - TX8 TX9 - TX10

Item ID: **TM708**



+

MINI TX KEY

- CrMo steel alloy for greater strength
- Rotating end piece for easier use when "transporting" the fastening

ITEM ID:	+	Tip	Weight g
MDM806T	TX6	TX	10
MDM807T	TX7	TX	10
MDM808T	TX8	TX	10
MDM809T	TX9	TX	15
MDM810T	TX10	TX	15
MDM815T	TX15	TX	15



6 Pieces

MINI TX T-HANDLE SCREWDRIVER SET 6 PIECES

- Especially designed bi-material handle for easier use
- Rotating end piece for easier use when "transporting" the fastening
- Supplied in a handy holder that can be wall mounted

Mini T Handle Screwdrivers:			
+	TX6	TX7	TX8
	TX9	TX10	TX15

Item ID: **MDM706TXT**

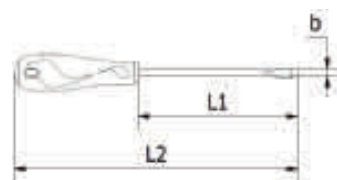

-

FLAT MINI SCREWDRIVER POCKET CLIP

- TT-MV PLUS steel alloy for greater strength and material flexibility
- Ergonomically designed bi-material handle for easy use with higher torque and faster speed
- Pocket clip
- Hole in the handle for hanging or for use with a fall protection wire if needed
- The handle is moulded around the blade to ensure straightness and to allow larger blade wings which give a higher torque capacity

ITEM ID:	b mm	L1 mm	L2 mm	Weight g
MDMC718N	3	50	120	12

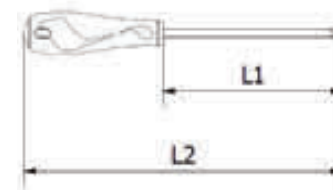

+

PH MINI SCREWDRIVER POCKET CLIP

- TT-MV PLUS steel alloy for greater strength and material flexibility
- Ergonomically designed bi-material handle for easy use with higher torque and faster speed
- Pocket clip
- Hole in the handle for hanging or for use with a fall protection wire if needed
- The handle is moulded around the blade to ensure straightness and to allow larger blade wings which give a higher torque capacity
- DIN ISO 8764

ITEM ID:	+	Tip	L1 mm	L2 mm	Weight g
MDMC715N	PH1	Phillips	50	120	12



2 Pieces

SCREWDRIVER SET FLAT & PH 2 PIECES

- TT-MV PLUS steel alloy for greater strength and material flexibility
- Ergonomically designed bi-material handles for easy use with higher torque and faster speed
- Pocket clip
- Hole in the handle for hanging or for use with a fall protection wire if needed
- The handle is moulded around the blade to ensure straightness and to allow larger blade wings which give a higher torque capacity

Screwdrivers:	
-	mm: 3 x 50
+	mm: PH1 x 50

Item ID: **MDMC702N**



CHOOSE THE RIGHT HANDLE FOR THE RIGHT TASK

A larger type of handle allows for more power and force to be executed with the driver while a smaller type of handle make it easier to work quickly as less force is required with the driver.

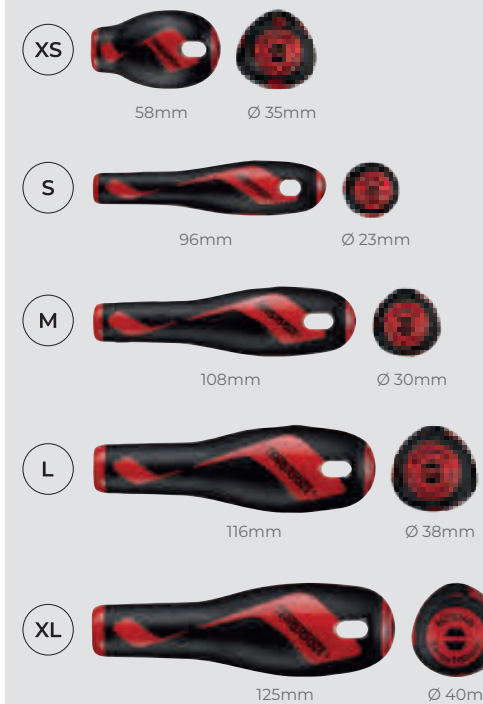



Do's and Dont's of Screwdrivers

Do's

- Use the right tip
- Keep it clean & dry
- Apply extra torque correctly
- Choose the right handle

Dont's

- Do not use the wrong tip
- Do not use the screwdriver as a lever
- Do not use on live electrics
- Do not use too much power

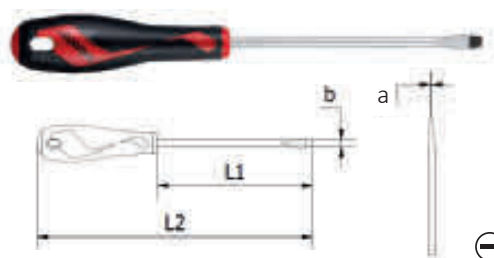

FLAT SCREWDRIVER

- TT-MV PLUS steel alloy for greater strength and material flexibility
- Ergonomically designed bi-material handle for easy use with higher torque and faster speed
- Hole in the handle for hanging or for use as a T handle for extra torque or with a fall protection wire if needed
- The handle is moulded around the blade to ensure straightness and to allow larger blade wings which give a higher torque capacity
- Designed and manufactured to DIN 2380

ITEM ID:	a mm	b mm	Shaft	Tip	L1 mm	L2 mm	Weight g	HDL
MD914N	0.4	2.5	Round	Parallel	50	146	24	S
MD915N	0.5	2.5	Round	Parallel	75	171	24	S
MD915N1	0.5	2.5	Round	Parallel	200	296	25	S
MD920N	0.5	3	Round	Parallel	75	171	27	S
MD920N1	0.5	3	Round	Parallel	100	196	31	S
MD916N	0.6	3.5	Round	Parallel	75	171	29	S
MD916N1	0.6	3.5	Round	Parallel	100	196	31	S
MD916N2	0.6	3.5	Round	Parallel	150	246	38	S

ITEM ID:	a mm	b mm	Shaft	Tip	L1 mm	L2 mm	Weight g	HDL
MD917N	0.8	4	Round	Parallel	100	196	31	S
MD917N1	0.8	4	Round	Parallel	400	496	41	S
MD917N2	0.8	4	Round	Parallel	150	246	38	S
MD922N	1	5.5	Round	Flared	75	246	38	S
MD923N	1	5.5	Round	Flared	150	258	64	M
MD923N1	1	5.5	Round	Flared	200	308	74	M
MD928N	1.2	6.5	Round	Flared	38	96	45	XS
MD928N1	1.2	6.5	Round	Flared	100	216	93	L
MD928N2	1.2	6.5	Round	Flared	150	266	105	L
MD928N3	1.2	6.5	Round	Flared	200	316	115	L
MD928N4	1.2	6.5	Round	Flared	100	208	105	M
MD928N5	1.2	6.5	Round	Flared	150	258	110	M
MD928N6	1.2	6.5	Round	Flared	200	308	113	M
MD928N7	1.2	6.5	Round	Flared	400	508	185	M
MD930N	1.6	10	Round	Flared	200	325	231	XL
MD931N	1	5.5	Hex	Flared	125	253	96	L
MD932N	1.2	6.5	Hex	Flared	100	216	101	L
MD932N1	1.2	6.5	Hex	Flared	150	266	114	L
MD932N2	1.2	6.5	Hex	Flared	400	516	181	L
MD934N	1.2	8	Hex	Flared	150	275	156	XL
MD935N	1.6	10	Hex	Flared	200	325	226	XL

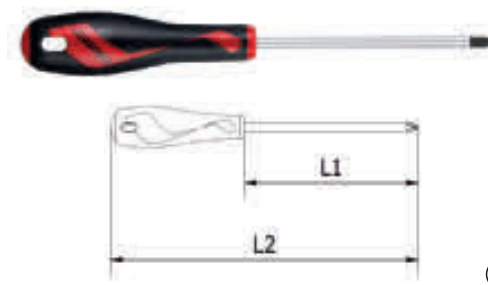

PH SCREWDRIVER

- TT-MV PLUS steel alloy for greater strength and material flexibility
- Ergonomically designed bi-material handle for easy use with higher torque and faster speed
- Hole in the handle for hanging or for use as a T handle for extra torque or with a fall protection wire if needed
- The handle is moulded around the blade to ensure straightness and to allow larger blade wings which give a higher torque capacity
- Designed and manufactured to DIN ISO 8764

ITEM ID:	Shaft	Tip	L1 mm	L2 mm	Weight g	HDL	
MD940N	PH0	Round	Phillips	75	171	27	S
MD940N1	PH0	Round	Phillips	300	396	41	S
MD947N	PH1	Round	Phillips	38	96	40	XS
MD947N1	PH1	Round	Phillips	75	183	29	M
MD947N2	PH1	Round	Phillips	150	258	61	M
MD948N	PH2	Round	Phillips	38	96	46	XS
MD948N1	PH2	Round	Phillips	100	216	93	L
MD948N2	PH2	Round	Phillips	200	316	115	L
MD948N3	PH2	Round	Phillips	400	516	153	L
MD948N4	PH2	Round	Phillips	100	208	90	M
MD948N5	PH2	Round	Phillips	200	308	110	M
MD948N6	PH2	Round	Phillips	400	508	148	M
MD948N8	PH2	Round	Phillips	300	408	114	M
MD949N	PH3	Round	Phillips	150	275	152	XL
MD950N	PH4	Round	Phillips	200	325	261	XL
MD952N	PH2	Hex	Phillips	100	216	101	L
MD952N1	PH2	Hex	Phillips	400	516	181	L
MD953N	PH3	Hex	Phillips	150	275	159	XL
MD954N	PH4	Hex	Phillips	200	325	231	XL

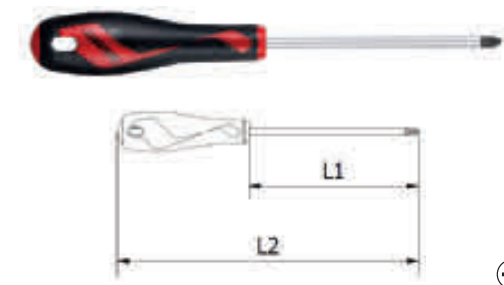

PZ SCREWDRIVER

- TT-MV PLUS steel alloy for greater strength and material flexibility
- Ergonomically designed bi-material handle for easy use with higher torque and faster speed
- Hole in the handle for hanging or for use as a T handle for extra torque or with a fall protection wire if needed
- The handle is moulded around the blade to ensure straightness and to allow larger blade wings which give a higher torque capacity
- Designed and manufactured to DIN ISO 8764

ITEM ID:	Shaft	Tip	L1 mm	L2 mm	Weight g	HDL	
MD960N	PZ0	Round	Pozi	75	171	27	S
MD961N	PZ1	Round	Pozi	75	183	29	M
MD961N1	PZ1	Round	Pozi	250	358	73	M
MD961N2	PZ1	Round	Pozi	38	96	40	XS
MD962N	PZ2	Round	Pozi	100	216	93	L
MD962N1	PZ2	Round	Pozi	150	266	105	L
MD962N2	PZ2	Hex	Pozi	100	216	101	L
MD962N3	PZ2	Round	Pozi	38	96	45	XS
MD962N4	PZ2	Round	Pozi	100	208	98	M
MD962N5	PZ2	Round	Pozi	150	258	100	M
MD962N4A	PZ2	Round	Pozi	200	308	93	M
MD962N4C	PZ2	Round	Pozi	300	408	93	M
MD962N4D	PZ2	Round	Pozi	400	508	93	M
MD963N	PZ3	Hex	Pozi	150	275	158	XL
MD964N	PZ4	Hex	Pozi	200	325	231	XL

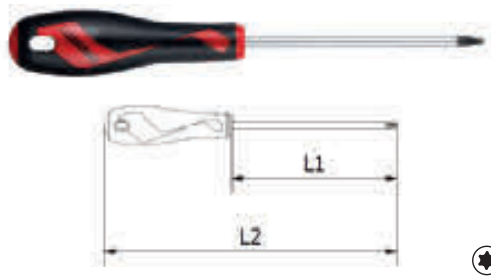

TX SCREWDRIVER

- TT-MV PLUS steel alloy for greater strength and material flexibility
- Ergonomically designed bi-material handle for easy use with higher torque and faster speed
- Hole in the handle for hanging or for use as a T handle for extra torque or with a fall protection wire if needed
- The handle is moulded around the blade to ensure straightness and to allow larger blade wings which give a higher torque capacity

ITEM ID:	Shaft	Tip	L1 mm	L2 mm	Weight g	HDL	
MD906TN	TX6	Round	TX	75	171	29	S
MD907TN	TX7	Round	TX	75	171	29	S
MD908TN	TX8	Round	TX	75	171	29	S
MD909TN	TX9	Round	TX	75	171	29	S
MD910TN	TX10	Round	TX	100	208	58	M
MD915TN	TX15	Round	TX	100	208	58	M
MD920TN	TX20	Round	TX	100	208	58	M
MD925TN	TX25	Round	TX	100	216	93	L
MD927TN	TX27	Round	TX	100	216	94	L
MD930TN	TX30	Round	TX	100	216	94	L
MD940TN	TX40	Round	TX	100	216	106	L
MD945TN	TX45	Round	TX	125	250	237	XL

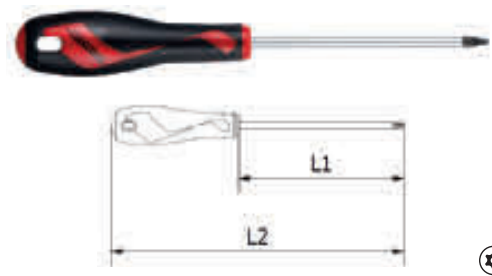

TPX SCREWDRIVER

- For use with tamper proof TX fastenings
- TT-MV PLUS steel alloy for greater strength and material flexibility
- Ergonomically designed bi-material handle for easy use with higher torque and faster speed
- Hole in the handle for hanging or for use as a T handle for extra torque or with a fall protection wire if needed
- The handle is moulded around the blade to ensure straightness and to allow larger blade wings which give a higher torque capacity

ITEM ID:	Shaft	Tip	L1 mm	L2 mm	Weight g	HDL	
MD610TPN	TPX10	Round	TPX	100	208	58	M
MD615TPN	TPX15	Round	TPX	100	208	58	M
MD620TPN	TPX20	Round	TPX	100	208	58	M
MD625TPN	TPX25	Round	TPX	100	216	94	L
MD627TPN	TPX27	Round	TPX	100	216	94	L
MD630TPN	TPX30	Round	TPX	100	216	94	L
MD640TPN	TPX40	Round	TPX	100	216	105	L

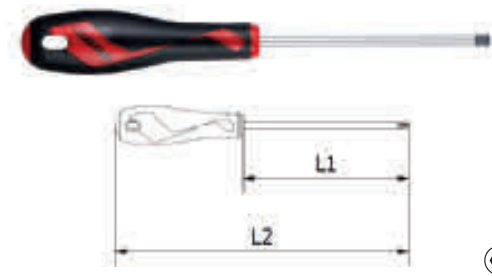

HEX SCREWDRIVER

- For use with hexagon fastenings and grub screws
- TT-MV PLUS steel alloy for greater strength and material flexibility
- Ergonomically designed bi-material handle for easy use with higher torque
- Hole in the handle for hanging or for use as a T handle for extra torque
- The handle is moulded around the blade to ensure straightness

ITEM ID:	Shaft	Tip	L1 mm	L2 mm
MD7020HN	2	Round Hex	100	196
MD7025HN	2.5	Round Hex	100	196
MD7030HN	3	Round Hex	100	196

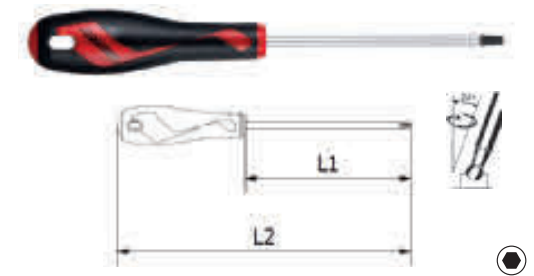

BALL POINT HEX SCREWDRIVER

- Ball point head allows turning at angles up to 25° for easier access
- For use with hexagon fastenings and grub screws
- TT-MV PLUS steel alloy for greater strength and material flexibility
- Ergonomically designed bi-material handle for easy use with higher torque
- Hole in the handle for hanging or for use as a T handle for extra torque
- The handle is moulded around the blade to ensure straightness

ITEM ID:	Shaft	Tip	L1 mm	L2 mm
MD7020HBN	2	Round Hex ball	100	196
MD7025HBN	2.5	Round Hex ball	100	196
MD7030HBN	3	Round Hex ball	150	246
MD7040HBN	4	Round Hex ball	150	258
MD7050HBN	5	Round Hex ball	150	266
MD7060HBN	6	Round Hex ball	150	266
MD7080HBN	8	Round Hex ball	150	275



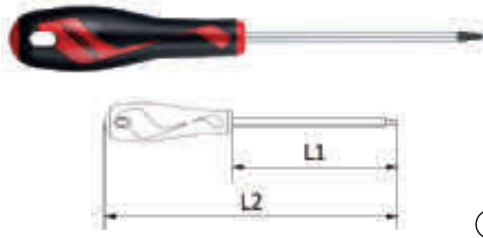

ROB SCREWDRIVER

- TT-MV PLUS steel alloy for greater strength and material flexibility
- Ergonomically designed bi-material handle for easy use with higher torque and faster speed
- Hole in the handle for hanging or for use as a T handle for extra torque or with a fall protection wire if needed
- The handle is moulded around the blade to ensure straightness and to allow larger blade wings which give a higher torque capacity

ITEM ID:	Shaft	Tip	L1 mm	L2 mm	Weight g	HDL
MD801N	1	Round	100	216	94	L
MD802N	2	Round	100	216	94	L
MD803N	3	Round	100	216	94	L



DOUBLE ENDED SCREWDRIVER BLADE

- Double ended screwdriver blade giving two tools in one
- Hexagon shaft enabling a wrench to be used for added control and torque
- TT-MV PLUS steel alloy for greater strength and material flexibility
- Sizes clearly marked on the shaft

ITEM ID:	TIP 1	SIZE 1	TIP 2	SIZE 2
MD901	SCREWDRIVER BLADE HANDLE			
PZZ0102	+	PZ1	+	PZ2
PHH0102	+	PH1	+	PH2
FTF4055	-	4	-	5.5
PHF0365	+	PH3	-	6.5
TXX1015	+	TX10	+	TX15
TXX2025	+	TX20	+	TX25
TXX3040	+	TX30	+	TX40
HBH0303	●	3 Ball	●	3
HBH0404	●	4 Ball	●	4
HBH0505	●	5 Ball	●	5
HBH0606	●	6 Ball	●	6



TT SERIES

SCREWDRIVER BLADE SET MIXED TTI 12 PIECES

- 22 screwdrivers in one set
- TT-MV PLUS steel alloy for greater strength and material flexibility
- Ergonomically designed bi-material handle for easy use with higher torque
- Hanging hole in the handle for use as a T handle or with a fall protection wire

Screwdriver Blade Handle With 1/4" Shank						
Screwdriver Blades:						
mm:	4 - 5.5					
	PH1 - PH2					
mm:	PH3 - 6.5					
	PZ1 - PZ2					
mm:	3 Ball - 3	4 Ball - 4	5 Ball - 5	6 Ball - 6		
TX:	10 - 15	20 - 25	30 - 40			

Item ID: TTMD12D

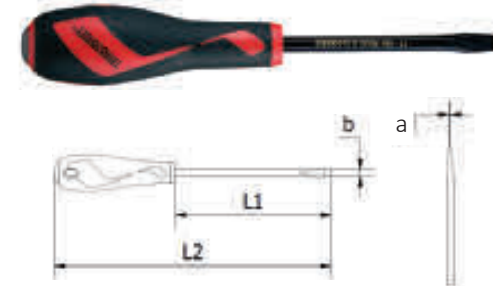

FLAT POWER THRU SCREWDRIVER

- Percussion cap and power through blade for striking with a hammer
- Ergonomically designed bi-material handle for easy use with higher torque and faster speed
- The hexagonal shaft allows tightening with an open ended spanner for extra torque if needed
- Designed and manufactured to DIN 2380

ITEM ID:	a mm	b mm	Shaft	Tip	L1 mm	L2 mm	Weight g	HDL	List Price
MDT932N	1.2	6.5	Hex	Flared	100	216	120	L	
MDT934N	1.2	8	Hex	Flared	150	275	200	XL	
MDT935N	1.6	10	Hex	Flared	200	325	200	XL	

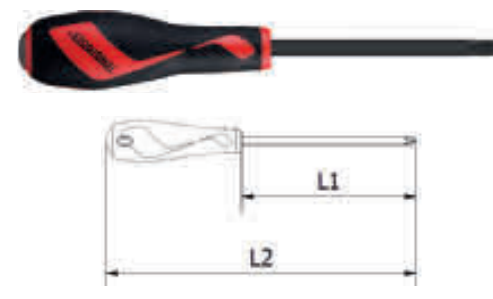

PH POWER THRU SCREWDRIVER

- Percussion cap and power through blade for striking with a hammer
- Ergonomically designed bi-material handle for easy use with higher torque and faster speed
- The hexagonal shaft allows tightening with an open ended spanner for extra torque if needed
- Designed and manufactured to DIN ISO 8764

ITEM ID:	Shaft	Tip	L1 mm	L2 mm	Weight g	HDL	List Price
MDT952N	PH2	Hex	Phillips	100	216	120	L
MDT953N	PH3	Hex	Phillips	150	275	200	XL



TT SERIES

POWER THROUGH SCREWDRIVER SET TTX4

- Chrome vanadium blades for greater strength and material flexibility
- Percussion cap and full length integral blade for use with a hammer to release stubborn screws
- Ergonomically designed bi-material handle for easy use with higher torque and faster speed
- The handle is moulded around the blade to ensure straightness and to allow larger blade wings which give a higher torque capacity

Screwdrivers:			
mm:	6.5 x 100	8 x 150	10 x 200
mm:	PH2 x 100	PH3 x 150	

Item ID: TTXMDTN



FOAM SERIES

POWER THROUGH SCREWDRIVER SET FOAMX4

- Chrome vanadium blades for greater strength and material flexibility
- Percussion cap and full length integral blade for use with a hammer to release stubborn screws
- Ergonomically designed bi-material handle for easy use with higher torque
- The handle is moulded around the blade to give a higher torque capacity
- Tools are held in place using three colour pre-cut EVA foam

Screwdrivers:			
mm:	6.5 x 100	8 x 150	10 x 200
mm:	PH2 x 100	PH3 x 150	

Item ID: TEXMDTN



5 Pieces

POWER THROUGH SCREWDRIVER WALL RACK

- Chrome vanadium blades for greater strength
- Percussion cap and full length integral blade for use with a hammer
- Ergonomically designed bi-material handle for easy use with higher torque
- The handle is moulded around the blade to ensure straightness
- Supplied with a wall rack for fixing to the wall or a workbench

Power Through Screwdrivers:

mm:	6.5 x 100	8 x 150	10 x 200
mm:	PH2 x 100	PH3 x 150	

Item ID: **WRMDT05N**



NUT DRIVER

- Single hexagon 6 point socket
- Screwdriver type handle for use with hexagon nuts and bolts
- Chrome vanadium steel alloy for greater strength
- Ergonomically designed bi-material handle for higher torque
- Hole in the handle for hanging or for use as a T handle for extra torque
- The handle is moulded around the blade to give a higher torque capacity
- Designed and manufactured to DIN3125

ITEM ID:	Size mm	Shaft Length	Overall Length	Weight g
MDN505	5	125	234	91
MDN5055	5.5	125	234	93
MDN506	6	125	234	93
MDN507	7	125	234	98
MDN508	8	125	234	102
MDN510	10	125	242	130
MDN511	11	125	242	153
MDN512	12	125	242	153
MDN513	13	125	242	160



T HANDLE NUT DRIVER

- Single hexagon 6 point socket
- T handle type driver for use with hexagon nuts and bolts
- Chrome vanadium steel alloy for greater strength
- Ergonomically designed bi-material handle for higher torque
- Hole in the handle for hanging or for use with a fall protection wire
- Designed and manufactured to DIN3125

ITEM ID:	Size mm	Overall Length
MDNT405	5	288
MDNT4055	5.5	288
MDNT406	6	288
MDNT407	7	288
MDNT408	8	288
MDNT409	9	288
MDNT410	10	288
MDNT411	11	288
MDNT412	12	288
MDNT413	13	288
MDNT414	14	288



TT SERIES

9 Pieces

mm

NUT DRIVER SET TTX4 9 PIECES

- 6 point socket ends for a perfect fit
- Chrome vanadium for greater strength and material flexibility
- Ergonomically designed bi-material handle for easy use with higher torque
- Hanging hole in the handle for use as a T handle or for use with a fall protection wire
- The handle is moulded around the blade which give a higher torque capacity

Nut Drivers:

5, 5.5, 6, 7, 8, 10, 11, 12, 13 mm

Item ID: **TTXND**



MAGNETIC SCREWDRIVER CHARGER

- Magnetic screwdriver charger and discharger
- Use to magnetise or demagnetise screwdrivers
- Supplied on a handy key ring

Item ID: **MR500**



TT SERIES

7 Pieces

SCREWDRIVER SET MIXED TT1 7 PIECES

- TT-MV PLUS steel alloy for greater strength and material flexibility
- Ergonomically designed bi-material handle for easy use with higher torque
- Hanging hole in the handle for use as a T handle or with a fall protection wire
- The handle is moulded around the blade to give a higher torque capacity

Screwdrivers:

mm:	3 x 75	5.5 x 75	6.5 x 100
mm:	PH0 x 75	PH1 x 75	PH2 x 100
mm:	PZ2 x 100		

Item ID: **TT917N**



TT SERIES

7 Pieces

SCREWDRIVER SET TX & TPX TT1 7 PIECES

- TT-MV PLUS steel alloy for greater strength and material flexibility
- Ergonomically designed bi-material handle for easy use with higher torque
- Hanging hole in the handle for use as a T handle or with a fall protection wire
- The handle is moulded around the blade to give a higher torque capacity

Screwdrivers:

mm:	TX6 x 75	TX9 x 75		
mm:	TPX10 x 100	TPX15 x 100	TPX20 x 100	
	TPX25 x 100	TPX30 x 100		

Item ID: **TT917TXN**



TT SERIES

14 Pieces

SCREWDRIVER SET MIXED TT2 14 PIECES

- TT-MV PLUS steel alloy for greater strength and material flexibility
- Ergonomically designed bi-material handle for easy use with higher torque
- Hanging hole in the handle for use as a T handle or with a fall protection wire
- The handle is moulded around the blade to give a higher torque capacity

Screwdrivers:

mm:	3 x 75	3.5 x 100	5.5 x 75	5.5 x 125
	6.5 x 38	6.5 x 100		
mm:	PH0 x 75	PH1 x 75	PH2 x 38	PH2 x 100
mm:	PZ0 x 75	PZ1 x 75	PZ2 x 38	PZ2 x 100

Item ID: **TTD914N**



TT SERIES



SCREWDRIVER SET TX TT2 12 PIECES

- TT-MV PLUS steel alloy for greater strength and material flexibility
- Ergonomically designed bi-material handle for easy use with higher torque
- Hanging hole in the handle for use as a T handle or with a fall protection wire
- The handle is moulded around the blade to give a higher torque capacity

Screwdrivers:				
mm:	TX6 x 75	TX7 x 75	TX8 x 75	TX9 x 75
	TX10 x 100	TX15 x 100	TX20 x 100	TX25 x 100
	TX27 x 100	TX30 x 100	TX40 x 100	TX45 x 125

Item ID: **TTD912TXN**



TT SERIES



SCREWDRIVER SET FLAT & PH TTX4 8 PIECES

- TT-MV PLUS steel alloy for greater strength and material flexibility
- Ergonomically designed bi-material handle for easy use with higher torque
- Hanging hole in the handle for use as a T handle or with a fall protection wire
- The handle is moulded around the blade to give a higher torque capacity

Screwdrivers:				
mm:	6.5 x 38	3 x 100	6.5 x 100	10 x 200
	5.5 x 150	8 x 150		
mm:	PH2 x 38	PH3 x 150		

Item ID: **TTX918N**



FOAM SERIES

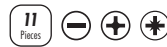

SCREWDRIVER SET MIXED FOAM2 11 PIECES

- TT-MV PLUS steel alloy for greater strength and material flexibility
- Ergonomically designed bi-material handle for easy use with higher torque
- Hanging hole in the handle for use as a T handle or with a fall protection wire
- The handle is moulded around the blade to give a higher torque capacity
- Tools are held in place using three colour pre-cut EVA foam

Screwdrivers:				
mm:	3.5 x 100	5.5 x 75	6.5 x 38	5.5 x 125
	6.5 x 100			
mm:	PH0 x 75	PH1 x 75	PH2 x 38	PH2 x 100
mm:	PZ1 x 75	PZ2 x 100		

Item ID: **TED911N**



FOAM SERIES



SCREWDRIVER SET TX FOAM2 9 PIECES

- TT-MV PLUS steel alloy for greater strength and material flexibility
- Ergonomically designed bi-material handle for easy use with higher torque
- Hanging hole in the handle for use as a T handle or with a fall protection wire
- The handle is moulded around the blade to give a higher torque capacity
- Tools are held in place using three colour pre-cut EVA foam

Screwdrivers:			
mm:	TX6 x 75	TX8 x 75	TX9 x 75
	TX10 x 100	TX15 x 100	TX20 x 100
	TX25 x 100	TX27 x 100	TX30 x 100

Item ID: **TED909TXN**



FOAM SERIES



SCREWDRIVER SET FLAT & PH FOAMX4 5 PIECES

- TT-MV PLUS steel alloy for greater strength and material flexibility
- Ergonomically designed bi-material handle for easy use with higher torque
- Hanging hole in the handle for use as a T handle or with a fall protection wire
- The handle is moulded around the blade to give a higher torque capacity
- Tools are held in place using three colour pre-cut EVA foam

Screwdrivers:			
mm:	5.5 x 150	6.5 x 150	8 x 150
			10 x 200
mm:	PH3 x 150		

Item ID: **TEX915N**

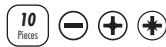

SCREWDRIVER SET WALL RACK 10 PIECES

- TT-MV PLUS steel alloy for greater strength and material flexibility
- Ergonomically designed bi-material handle for easy use with higher torque
- The handle is moulded around the blade to ensure straightness
- Supplied with a wall rack for fixing to the wall or a workbench

Screwdrivers:			
mm:	3 x 100	5.5 x 75	5.5 x 150
	6.5 x 150	8 x 150	
mm:	PH0 x 75	PH1 x 75	PH2 x 100
mm:	PZ1 x 75	PZ2 x 100	

Item ID: **WRMD10N**



SCREWDRIVER SET MIXED 53 PIECES

- TT-MV PLUS steel alloy for greater strength and material flexibility
- Ergonomically designed bi-material handle for easy use with higher torque and faster speed
- Hole in the handle for hanging or for use as a T handle for extra torque or with a fall protection wire if needed
- The handle is moulded around the blade to ensure straightness and to allow larger blade wings which give a higher torque capacity
- Includes Ratcheting bits driver with 1/4" hex drive 25mm length bits
- Bits range includes Flat, PH, PZ, TX, TPX, ROB and hexagon sizes
- Supplied in a handy carrying case

1/4" hex x 1/4" square drive adaptor					
Screwdrivers:					
⊖	mm:	3.0 x 75	3.0 x 100	4.0 x 100	5.5 x 75
		5.5 x 150	6.0 x 38	6.5 x 100	6.5 x 150
		8.0 x 150	10.0 x 200		
⊕	mm:	PH1 x 75	PH2 x 38	PH2 x 100	PH3 x 150
⊕	mm:	PZ0 x 75	PZ1 x 75	PZ2 x 38	PZ2 x 100
		PZ3 x 150			
Ratcheting Bits Driver					
25 mm BITS:					
⊖	mm:	1.2 x 5	1.4 x 7		
⊕		PH1	PH2		
⊕		PZ0	PZ1	PZ2	
⊕		TX6	TX7	TX8	TX9
		TX10	TX15 (x2)	TX20 (x2)	TX25 (x2)
		TX30	TX40		
⊕		TPX20	TPX25	TPX30	
⊕		ROB1	ROB2	ROB3	
⊕	mm:	2	3	4	5
		6	8		

Item ID: MD9053N



SCREWDRIVER SET MIXED 10 PIECES

- Includes 1,000 volt insulated 3.0mm flat blade screwdriver
- TT-MV PLUS steel alloy for greater strength and material flexibility
- Ergonomically designed bi-material handle for easy use with higher torque and faster speed
- Hole in the handle for hanging or for use as a T handle for extra torque or with a fall protection wire if needed
- The handle is moulded around the blade to ensure straightness and to allow larger blade wings which give a higher torque capacity
- Supplied in a handy carrying case

Screwdrivers:					
⊖	mm:	3.0 x 100	5.5 x 75	5.5 x 150	6.5 x 150
⊖	mm:	3.0 x 100			
⊕	mm:	PH0 x 75	PH1 x 75	PH2 x 100	
⊕	mm:	PZ1 x 75	PZ2 x 100		

Item ID: MD910N



SCREWDRIVER SET MIXED 11 PIECES

- TT-MV PLUS steel alloy for greater strength and material flexibility
- Ergonomically designed bi-material handle for easy use with higher torque and faster speed
- Hole in the handle for hanging or for use as a T handle for extra torque or with a fall protection wire if needed
- The handle is moulded around the blade to ensure straightness and to allow larger blade wings which give a higher torque capacity
- Supplied in a handy carrying case

Screwdrivers:					
⊖	mm:	3 x 100	5.5 x 75	5.5 x 150	6.5 x 38
		6.5 x 150			
⊕	mm:	PH0 x 75	PH1 x 75	PH2 x 38	PH2 x 100
⊕	mm:	PZ1 x 75	PZ2 x 100		

Item ID: MD911N



SCREWDRIVER SET FLAT 5 PIECES

- TT-MV PLUS steel alloy for greater strength and material flexibility
- Ergonomically designed bi-material handle for easy use with higher torque and faster speed
- Hole in the handle for hanging or for use as a T handle for extra torque or with a fall protection wire if needed
- The handle is moulded around the blade to ensure straightness and to allow larger blade wings which give a higher torque capacity
- Supplied in a full colour display box with PS tray

Screwdrivers:			
⊖	mm:	2.5 x 50	3 x 75
		4 x 100	5.5 x 150
		6.5 x 150	

Item ID: MD906N5



SCREWDRIVER SET MIXED 6 PIECES

- TT-MV PLUS steel alloy for greater strength and material flexibility
- Ergonomically designed bi-material handle for easy use with higher torque and faster speed
- Hole in the handle for hanging or for use as a T handle for extra torque or with a fall protection wire if needed
- The handle is moulded around the blade to ensure straightness and to allow larger blade wings which give a higher torque capacity
- Supplied in a full colour display box with PS tray

Screwdrivers:			
⊖	mm:	3 x 75	5.5 x 100
⊕	mm:	PH1 x 75	PH2 x 100
⊕	mm:	PZ1 x 75	PZ2 x 100

Item ID: MD906N



6 Pieces

SCREWDRIVER SET FLAT & PH 6 PIECES

- TT-MV PLUS steel alloy for greater strength and material flexibility
- Ergonomically designed bi-material handle for easy use with higher torque and faster speed
- Hole in the handle for hanging or for use as a T handle for extra torque or with a fall protection wire if needed
- The handle is moulded around the blade to ensure straightness and to allow larger blade wings which give a higher torque capacity
- Supplied in a full colour display box with PS tray

Screwdrivers:					
⊖	mm:	3 x 75	4 x 100	5.5 x 75	6.5 x 100
⊕	mm:	PH1 x 75	PH2 x 100		

Item ID: MD906N3



6 Pieces

SCREWDRIVER SET FLAT & PZ 6 PIECES

- TT-MV PLUS steel alloy for greater strength and material flexibility
- Ergonomically designed bi-material handle for easy use with higher torque and faster speed
- Hole in the handle for hanging or for use as a T handle for extra torque or with a fall protection wire if needed
- The handle is moulded around the blade to ensure straightness and to allow larger blade wings which give a higher torque capacity
- Supplied in a full colour display box with PS tray

Screwdrivers:					
⊖	mm:	3 x 75	4 x 100	5.5 x 75	6.5 x 100
⊕	mm:	PZ1 x 75	PZ2 x 100		

Item ID: MD906N4



6 Pieces

SCREWDRIVER SET PZ & TX 6 PIECES

- TT-MV PLUS steel alloy for greater strength and material flexibility
- Ergonomically designed bi-material handle for easy use with higher torque and faster speed
- Hole in the handle for hanging or for use as a T handle for extra torque or with a fall protection wire if needed
- The handle is moulded around the blade to ensure straightness and to allow larger blade wings which give a higher torque capacity
- Supplied in a full colour display box with PS tray

Screwdrivers:					
⊕	mm:	PZ1 x 75	PZ2 x 100		
⊕	mm:	TX10 x 100	TX15 x 100	TX20 x 100	TX25 x 100

Item ID: MD906N2



6 Pieces

SCREWDRIVER SET TX 6 PIECES

- TT-MV PLUS steel alloy for greater strength and material flexibility
- Ergonomically designed bi-material handle for easy use with higher torque and faster speed
- Hole in the handle for hanging or for use as a T handle for extra torque or with a fall protection wire if needed
- The handle is moulded around the blade to ensure straightness and to allow larger blade wings which give a higher torque capacity
- Supplied in a full colour display box with PS tray

Screwdrivers:					
⊕	mm:	TX10 x 100	TX15 x 100	TX20 x 100	
		TX25 x 100	TX30 x 100	TX40 x 100	

Item ID: MD906N1

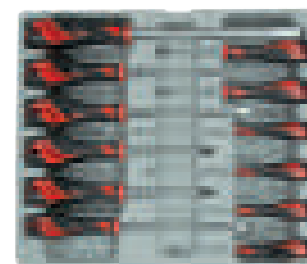

12 Pieces

SCREWDRIVER SET MIXED 12 PIECES

- TT-MV PLUS steel alloy for greater strength and material flexibility
- Ergonomically designed bi-material handle for easy use with higher torque and faster speed
- Hole in the handle for hanging or for use as a T handle for extra torque or with a fall protection wire if needed
- The handle is moulded around the blade to ensure straightness and to allow larger blade wings which give a higher torque capacity
- Supplied in a full colour display box with PS tray

Screwdrivers:					
⊖	mm:	2.5 x 75	3.5 x 100	4 x 150	5.5 x 150
		6.5 x 150	10 x 200		
⊕	mm:	PH0 x 75	PH1 x 75	PH2 x 100	PH2 x 200
⊕	mm:	PZ1 x 75	PZ2 x 100		

Item ID: MD912N



12 Pieces

SCREWDRIVER SET MIXED & INSULATED

- TT-MV PLUS steel alloy for greater strength and material flexibility
- Ergonomically designed bi-material handle for easy use with higher torque and faster speed
- Hole in the handle for hanging or for use as a T handle for extra torque or with a fall protection wire if needed
- The handle is moulded around the blade to ensure straightness and to allow larger blade wings which give a higher torque capacity
- Supplied in a full colour display box with PS tray

Screwdrivers:					
⊖	mm:	2.5 x 75	3.5 x 100	5.5 x 150	
⊖	mm:	2.5 x 75	3.0 x 100		
⊕	mm:	PH1 x 75	PH1 x 80		
⊕	mm:	PH2 x 100			
⊕	mm:	PZ2 x 100			
⊕	mm:	TX20 x 100	TX25 x 100	TX30 x 100	

Item ID: MD912N1

BITS & DRIVERS

QUALITY YOU CAN TRUST

All TengTools bits with a hexagonal drive are designed and manufactured in accordance with the latest industrial standards. Screwdriver bits and socket bits are classified as consumables and thus are only guaranteed to meet dimensional standards.

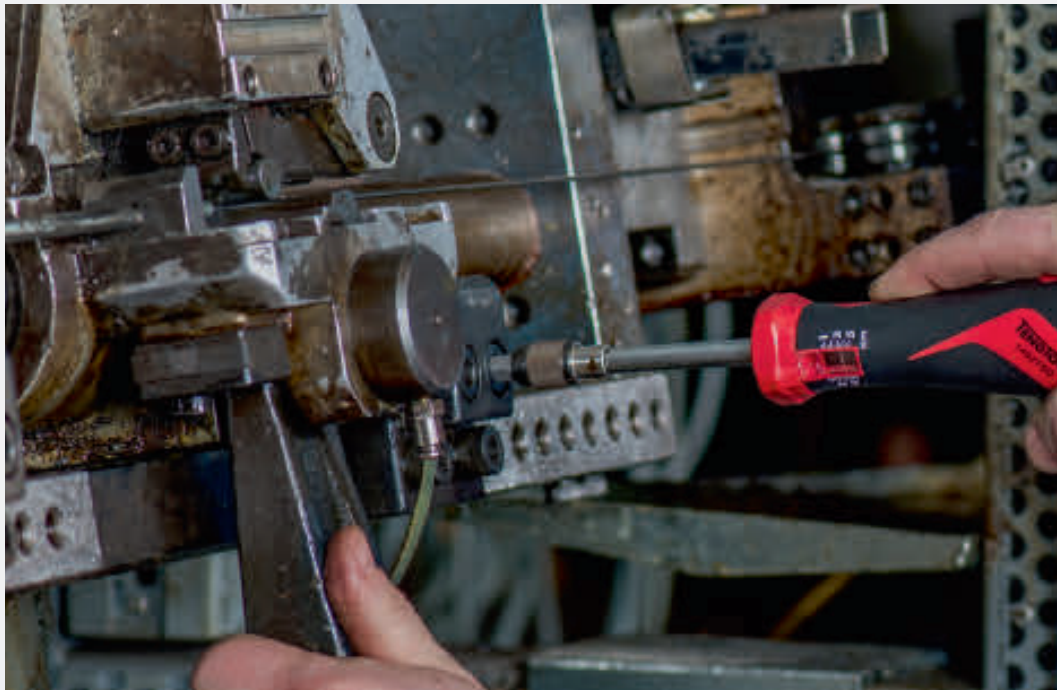

Bit sets supplied in handy pocket sized storage with bits that are easy to access. More belt clip sets have been added to the range to help you keep small tool sets in arms reach at all times.



An extensive range of bit drivers are available in the range including ratcheting drivers, stubby drivers and folding handle drivers for greater power transfer. A selection of drivers offer the option of storing bits in the handle so you do not have to waste time searching for bits when you need them.



1/4" DOUBLE ENDED FLAT BITS

- Designed for use with slotted type screws and fastenings
- Ideal for use with rechargeable and electric screwdrivers
- Designed and manufactured to DIN ISO 1173 & DIN ISO 2380

ITEM ID	Size 1 mm	Size 2 mm	Drive	Pack Qty	Length mm
FTF32406005	0.8 x 4	1.2 x 6	1/4" Hex	5	32



1/4" FLAT BITS 25MM

- For use with 1/4" hex drive bit holders and accessories
- Designed for use with slotted type screws and fastenings
- Designed and manufactured to DIN ISO 1173 & DIN ISO 2351-1

ITEM ID	Size mm	Drive	Pack Qty	Length mm
FL2506A03	0.6 x 3.5	1/4" Hex	3	25
FL2506B03	0.6 x 4.5	1/4" Hex	3	25
FL2508A03	0.8 x 4	1/4" Hex	3	25
FL2508B03	0.8 x 5.5	1/4" Hex	3	25
FL2510A03	1.0 x 5.5	1/4" Hex	3	25
FL2512A03	1.2 x 6.5	1/4" Hex	3	25
FL2516A03	1.6 x 8	1/4" Hex	3	25



1/4" FLAT BITS 50MM

- For use with 1/4" hex drive bit holders and accessories
- Designed for use with slotted type screws and fastenings
- Designed and manufactured to DIN ISO 1173 & DIN ISO 2351-1

ITEM ID	Size mm	Drive	Pack Qty	Length mm
FL5006A03	0.6 x 3.5	1/4" Hex	3	50
FL5008A03	0.8 x 4	1/4" Hex	3	50
FL5008B03	0.8 x 5.5	1/4" Hex	3	50
FL5010A03	1.0 x 5.5	1/4" Hex	3	50
FL5012A03	1.2 x 6.5	1/4" Hex	3	50



1/4" FLAT BITS 70MM

- For use with 1/4" hex drive bit holders and accessories
- Designed for use with slotted type screws and fastenings
- Designed and manufactured to DIN ISO 1173 & DIN ISO 2351-1

ITEM ID	Size mm	Drive	Pack Qty	Length mm
FL7006A02	0.6 x 3.5	1/4" Hex	2	70
FL7008A02	0.8 x 4	1/4" Hex	2	70
FL7008B02	0.8 x 5.5	1/4" Hex	2	70
FL7010A02	1.0 x 5.5	1/4" Hex	2	70



1/4" FLAT BITS 89MM

- For use with 1/4" hex drive bit holders and accessories
- Designed for use with slotted type screws and fastenings
- Designed and manufactured to DIN ISO 1173 & DIN ISO 2351-1

ITEM ID	Size mm	Drive	Pack Qty	Length mm
FL8905A01	0.5 x 3	1/4" Hex	1	89
FL8908A01	0.8 x 4	1/4" Hex	1	89



1/4" DOUBLE ENDED PH BITS

- Designed for use with Phillips type screws and fastenings
- Ideal for use with rechargeable and electric screwdrivers
- Designed and manufactured to DIN ISO 1173 & DIN ISO 8764-1

ITEM ID	Size 1 mm	Size 2 mm	Drive	Pack Qty	Length mm
PHH32000305	PH0	PH3	1/4" Hex	5	32
PHH32010205	PH1	PH2	1/4" Hex	5	32



1/4" PH BITS 25MM

- For use with 1/4" hex drive bit holders and accessories
- Designed for use with Phillips type screws and fastenings
- Designed and manufactured to DIN 3126/ISO 1173

ITEM ID	Size mm	Drive	Pack Qty	Length mm
PH2500103	PH1	1/4" Hex	3	25
PH2500110	PH1	1/4" Hex	10	25
PH2500203	PH2	1/4" Hex	3	25
PH2500210	PH2	1/4" Hex	10	25
PH2500303	PH3	1/4" Hex	3	25
PH2500310	PH3	1/4" Hex	10	25



1/4" PH BITS 50MM

- For use with 1/4" hex drive bit holders and accessories
- Designed for use with Phillips type screws and fastenings
- Designed and manufactured to DIN 3126/ISO 1173

ITEM ID	Size mm	Drive	Pack Qty	Length mm
PH5000103	PH1	1/4" Hex	3	50
PH5000203	PH2	1/4" Hex	3	50
PH5000303	PH3	1/4" Hex	3	50



1/4" PH BITS 70MM

- For use with 1/4" hex drive bit holders and accessories
- Designed for use with Phillips type screws and fastenings
- Designed and manufactured to DIN 3126/ISO 1173

ITEM ID	Size mm	Drive	Pack Qty	Length mm
PH7000102	PH1	1/4" Hex	2	70
PH7000202	PH2	1/4" Hex	2	70



1/4" PH BITS 89MM

- For use with 1/4" hex drive bit holders and accessories
- Designed for use with Phillips type screws and fastenings
- Designed and manufactured to DIN 8764-1

ITEM ID	Size mm	Drive	Pack Qty	Length mm
PH8900101	PH1	1/4" Hex	1	89
PH8900201	PH2	1/4" Hex	1	89



1/4" PH IMPACT BITS

- Designed for higher torsion
- For use with 1/4" hex drive bit holders and accessories
- Designed for use with Phillips type screws and fastenings

ITEM ID	Size mm	Drive	Pack Qty	Length mm
PHP3000101	PH1	1/4" Hex	1	30
PHP3000105	PH1	1/4" Hex	5	30
PHP3000201	PH2	1/4" Hex	1	30
PHP3000205	PH2	1/4" Hex	5	30
PHP3000301	PH3	1/4" Hex	1	30
PHP3000305	PH3	1/4" Hex	5	30
PHP5000101	PH1	1/4" Hex	1	50
PHP5000201	PH2	1/4" Hex	1	50
PHP5000301	PH3	1/4" Hex	1	50
PHP8900201	PH2	1/4" Hex	1	89



1/4" PH2G BITS 25MM

- GR type with reduced neck designed for use with dry wall screws
- For use with 1/4" hex drive bit holders and accessories
- Designed for use with Phillips type screws and fastenings
- Designed and manufactured to DIN 3126/ISO 1173

ITEM ID	Size mm	Drive	Pack Qty	Length mm
GR25002010	PH2G	1/4" Hex	10	25
GR25002100	PH2G	1/4" Hex	100	25



1/4" PH2G IMPACT BITS

- Designed for higher torsion
- PH2G type with reduced neck designed for use with dry wall screws
- For use with 1/4" hex drive bit holders and accessories

ITEM ID	Size mm	Drive	Pack Qty	Length mm
GRP3000201	PH2G	1/4" Hex	1	30
GRP3000205	PH2G	1/4" Hex	5	30
GRP5000201	PH2G	1/4" Hex	1	50



1/4" PZ BITS 50MM

- For use with 1/4" hex drive bit holders and accessories
- Designed for use with Pozidriv type screws and fastenings
- Designed and manufactured to DIN 3126/ ISO 1173

ITEM ID	Size mm	Drive	Pack Qty	Length mm
PZ5000103	PZ1	1/4" Hex	3	50
PZ5000203	PZ2	1/4" Hex	3	50
PZ5000303	PZ3	1/4" Hex	3	50



1/4" PZ IMPACT BITS

- Designed for higher torsion
- For use with 1/4" hex drive bit holders and accessories
- Designed for use with Pozidriv type screws and fastenings

ITEM ID	Size mm	Drive	Pack Qty	Length mm
PZP3000101	PZ1	1/4" Hex	1	30
PZP3000105	PZ1	1/4" Hex	5	30
PZP3000201	PZ2	1/4" Hex	1	30
PZP3000205	PZ2	1/4" Hex	5	30
PZP3000301	PZ3	1/4" Hex	1	30
PZP3000305	PZ3	1/4" Hex	5	30
PZP5000101	PZ1	1/4" Hex	1	50
PZP5000201	PZ2	1/4" Hex	1	50
PZP5000301	PZ3	1/4" Hex	1	50
PZP8900201	PZ2	1/4" Hex	1	89



1/4" TX BITS 25MM

- For use with 1/4" hex drive bit holders and accessories
- Designed for use with fastenings with an internal TX type hole
- Designed and manufactured to DIN ISO 1173

ITEM ID	Size mm	Drive	Pack Qty	Length mm
TX2500603	TX6	1/4" Hex	3	25
TX2500703	TX7	1/4" Hex	3	25
TX2500803	TX8	1/4" Hex	3	25
TX2500903	TX9	1/4" Hex	3	25
TX2501003	TX10	1/4" Hex	3	25
TX2501503	TX15	1/4" Hex	3	25
TX2502003	TX20	1/4" Hex	3	25
TX2502503	TX25	1/4" Hex	3	25
TX2502703	TX27	1/4" Hex	3	25
TX2503003	TX30	1/4" Hex	3	25
TX2504003	TX40	1/4" Hex	3	25



1/4" DOUBLE ENDED PZ BITS

- Designed for use with Pozidriv type screws and fastenings
- Ideal for use with rechargeable and electric screwdrivers
- Designed and manufactured to DIN3126

ITEM ID	Size 1 mm	Size 2 mm	Drive	Pack Qty	Length mm
PZZ32000305	PZ0	PZ3	1/4" Hex	5	32
PZZ32010205	PZ1	PZ2	1/4" Hex	5	32



1/4" PZ BITS 70MM

- For use with 1/4" hex drive bit holders and accessories
- Designed for use with Pozidriv type screws and fastenings
- Designed and manufactured to DIN 3126/ ISO 1173

ITEM ID	Size mm	Drive	Pack Qty	Length mm
PZ7000102	PZ1	1/4" Hex	2	70
PZ7000202	PZ2	1/4" Hex	2	70



1/4" PZ BITS 25MM

- For use with 1/4" hex drive bit holders and accessories
- Designed for use with Pozidriv type screws and fastenings
- Designed and manufactured to DIN 3126/ ISO 1173

ITEM ID	Size mm	Drive	Pack Qty	Length mm
PZ2500103	PZ1	1/4" Hex	3	25
PZ2500110	PZ1	1/4" Hex	10	25
PZ2500203	PZ2	1/4" Hex	3	25
PZ2500210	PZ2	1/4" Hex	10	25
PZ2500303	PZ3	1/4" Hex	3	25
PZ2500310	PZ3	1/4" Hex	10	25



1/4" PZ BITS 89MM

- For use with 1/4" hex drive bit holders and accessories
- Designed for use with Pozidriv type screws and fastenings
- Designed and manufactured to DIN 3126/ ISO 1173

ITEM ID	Size mm	Drive	Pack Qty	Length mm
PZ8900101	PZ1	1/4" Hex	1	89
PZ8900201	PZ2	1/4" Hex	1	89



1/4" DOUBLE ENDED TX BITS

- For use with fastenings with an internal TX type hole
- Ideal for use with rechargeable and electric screwdrivers
- Designed and manufactured to DIN ISO 1173

ITEM ID	Size 1 mm	Size 2 mm	Drive	Pack Qty	Length mm
TXX32101505	TX10	TX15	1/4" Hex	5	32
TXX32202505	TX20	TX25	1/4" Hex	5	32



1/4" TX BITS 50MM

- For use with 1/4" hex drive bit holders and accessories
- Designed for use with fastenings with an internal TX type hole
- Designed and manufactured to DIN ISO 1173

ITEM ID	Size mm	Drive	Pack Qty	Length mm
TX5000803	TX8	1/4" Hex	3	50
TX5001003	TX10	1/4" Hex	3	50
TX5001503	TX15	1/4" Hex	3	50
TX5002003	TX20	1/4" Hex	3	50
TX5002503	TX25	1/4" Hex	3	50
TX5002703	TX27	1/4" Hex	3	50
TX5003003	TX30	1/4" Hex	3	50



1/4" TX BITS 70MM

- For use with 1/4" hex drive bit holders and accessories
- Designed for use with fastenings with an internal TX type hole
- Designed and manufactured to DIN ISO 1173

ITEM ID	Size mm	Drive	Pack Qty	Length mm
TX7001002	TX10	1/4" Hex	2	70
TX7001502	TX15	1/4" Hex	2	70
TX7002002	TX20	1/4" Hex	2	70
TX7002502	TX25	1/4" Hex	2	70



1/4" TX BITS 89MM

- For use with 1/4" hex drive bit holders and accessories
- Designed for use with fastenings with an internal TX type hole
- Designed and manufactured to DIN ISO 1173

ITEM ID	Size mm	Drive	Pack Qty	Length mm
TX8901001	TX10	1/4" Hex	1	89
TX8902001	TX20	1/4" Hex	1	89
TX8902501	TX25	1/4" Hex	1	89
TX8903001	TX30	1/4" Hex	1	89



1/4" TX IMPACT BITS

- Designed for higher torsion
- For use with 1/4" hex drive bit holders and accessories
- Designed for use with fastenings with an internal TX hole

ITEM ID	Size mm	Drive	Pack Qty	Length mm
TXP3001001	TX10	1/4" Hex	1	30
TXP3001005	TX10	1/4" Hex	5	30
TXP3001501	TX15	1/4" Hex	1	30
TXP3001505	TX15	1/4" Hex	5	30
TXP3002001	TX20	1/4" Hex	1	30
TXP3002005	TX20	1/4" Hex	5	30
TXP3002501	TX25	1/4" Hex	1	30
TXP3002505	TX25	1/4" Hex	5	30
TXP3002701	TX27	1/4" Hex	1	30
TXP3002705	TX27	1/4" Hex	5	30
TXP3003001	TX30	1/4" Hex	1	30
TXP3003005	TX30	1/4" Hex	5	30
TXP3004001	TX40	1/4" Hex	1	30
TXP3004005	TX40	1/4" Hex	5	30
TXP5001001	TX10	1/4" Hex	1	50
TXP5001501	TX15	1/4" Hex	1	50
TXP5002001	TX20	1/4" Hex	1	50
TXP5002501	TX25	1/4" Hex	1	50
TXP5002701	TX27	1/4" Hex	1	50
TXP5003001	TX30	1/4" Hex	1	50
TXP5004001	TX40	1/4" Hex	1	50
TXP8902001	TX20	1/4" Hex	1	89
TXP8902501	TX25	1/4" Hex	1	89
TXP8903001	TX30	1/4" Hex	1	89



TX BITS 40MM

- 10/12 mm hexagon drive for use with appropriate bit holders
- Designed for use with fastenings with a TX hole
- Designed and manufactured to DIN ISO 1173

ITEM ID	Size mm	Drive	Pack Qty	Length mm
220720	TX20	10mm Hex	1	40
220725	TX25	10mm Hex	1	40
220727	TX27	10mm Hex	1	40
220730	TX30	10mm Hex	1	40
220740	TX40	10mm Hex	1	40
220745	TX45	10mm Hex	1	40
220750	TX50	10mm Hex	1	40
220755	TX55	10mm Hex	1	40
220760	TX60	12mm Hex	1	40
220770	TX70	12mm Hex	1	40



TX BITS 75MM

- 10/12 mm hexagon drive for use with appropriate bit holders
- Designed for use with fastenings with a TX hole
- Designed and manufactured to DIN ISO 1173

ITEM ID	Size mm	Drive	Pack Qty	Length mm
220820	TX20	10mm Hex	1	75
220825	TX25	10mm Hex	1	75
220827	TX27	10mm Hex	1	75
220830	TX30	10mm Hex	1	75
220840	TX40	10mm Hex	1	75
220845	TX45	10mm Hex	1	75
220850	TX50	10mm Hex	1	75
220855	TX55	10mm Hex	1	75
220860	TX60	12mm Hex	1	75
220870	TX70	12mm Hex	1	75



1/4" TPX BITS 25MM

- For use with 1/4" hex drive bit holders and accessories
- Designed for use with fastenings with a tamper proof TPX type hole
- Use with internal TPX heads
- Designed and manufactured to DIN ISO 1173

ITEM ID	Size mm	Drive	Pack Qty	Length mm
TPX2501003	TPX10	1/4" Hex	3	25
TPX2501503	TPX15	1/4" Hex	3	25
TPX2502003	TPX20	1/4" Hex	3	25
TPX2502503	TPX25	1/4" Hex	3	25
TPX2502703	TPX27	1/4" Hex	3	25
TPX2503003	TPX30	1/4" Hex	3	25
TPX2504003	TPX40	1/4" Hex	3	25



1/4" HEX BITS 25MM

- For use with 1/4" hex drive bit holders and accessories
- Designed for use with fastenings with a hexagon hole
- Use with in-hex screws or grub screws
- Designed and manufactured to DIN 3126/ ISO 1173

ITEM ID	Size mm	Drive	Pack Qty	Length mm
HEX2500203	2	1/4" Hex	3	25
HEX2500303	3	1/4" Hex	3	25
HEX2500403	4	1/4" Hex	3	25
HEX2500503	5	1/4" Hex	3	25
HEX2500603	6	1/4" Hex	3	25
HEX2500803	8	1/4" Hex	3	25



1/4" HEX BITS 50MM

- For use with 1/4" hex drive bit holders and accessories
- Designed for use with fastenings with a hexagon hole
- Use with in-hex screws or grub screws
- Designed and manufactured to DIN 3126 / ISO 1173

ITEM ID	Size mm	Drive	Pack Qty	Length mm
HEX5000403	4	1/4" Hex	3	50
HEX5000503	5	1/4" Hex	3	50
HEX5000603	6	1/4" Hex	3	50
HEX5000803	8	1/4" Hex	3	50



1/4" HEX BITS 89MM

- For use with 1/4" hex drive bit holders and accessories
- Designed for use with fastenings with a hexagon hole
- Use with in-hex screws or grub screws
- Designed and manufactured to DIN 3126 / ISO 1173

ITEM ID	Size mm	Drive	Pack Qty	Length mm
HEX8900401	4	1/4" Hex	1	89



1/4" HEX IMPACT BITS

- Designed for higher torsion
- For use with 1/4" hex drive bit holders and accessories
- Designed for use with fastenings with a hexagon hole
- Use with in-hex screws or grub screws

ITEM ID	Size mm	Drive	Pack Qty	Length mm
HEXP3000301	3mm	1/4" Hex	1	30
HEXP3000305	3mm	1/4" Hex	5	30
HEXP3000401	4mm	1/4" Hex	1	30
HEXP3000405	4mm	1/4" Hex	5	30
HEXP3000501	5mm	1/4" Hex	1	30
HEXP3000505	5mm	1/4" Hex	5	30
HEXP3000601	6mm	1/4" Hex	1	30
HEXP3000605	6mm	1/4" Hex	5	30
HEXP5000301	3mm	1/4" Hex	1	50
HEXP5000401	4mm	1/4" Hex	1	50
HEXP5000501	5mm	1/4" Hex	1	50
HEXP5000601	6mm	1/4" Hex	1	50



HEX BITS 40MM

- 10mm/12mm hexagon drive for use with appropriate bit holders
- Designed for use with fastenings with a hexagon hole
- Designed and manufactured to DIN 3126 / ISO 1173

ITEM ID	Size mm	Drive	Pack Qty	Length mm
210705	5	10mm Hex	1	40
210706	6	10mm Hex	1	40
210707	7	10mm Hex	1	40
210708	8	10mm Hex	1	40
210709	9	10mm Hex	1	40
210710	10	10mm Hex	1	40
210712	12	12mm Hex	1	40
210714	14	12mm Hex	1	40
210717	17	12mm Hex	1	40
210719	19	12mm Hex	1	40



HEX BITS 75MM

- 10mm/12mm hexagon drive for use with appropriate bit holders
- Designed for use with fastenings with a hexagon hole
- Designed and manufactured to DIN 3126 / ISO 1173

ITEM ID	Size mm	Drive	Pack Qty	Length mm
210805	5	10mm Hex	1	75
210806	6	10mm Hex	1	75
210807	7	10mm Hex	1	75
210808	8	10mm Hex	1	75
210809	9	10mm Hex	1	75
210810	10	10mm Hex	1	75
210812	12	12mm Hex	1	75
210814	14	12mm Hex	1	75
210817	17	12mm Hex	1	75
210819	19	12mm Hex	1	75



1/4" ROB BITS 25MM

- For use with 1/4" hex drive bit holders and accessories
- Designed for screws and fastenings with a square hole
- Designed and manufactured to DIN 3126 / ISO 1173

ITEM ID	Size mm	Drive	Pack Qty	Length mm
ROB2500103	ROB1	1/4" Hex	3	25
ROB2500203	ROB2	1/4" Hex	3	25
ROB2500303	ROB3	1/4" Hex	3	25



1/4" ROB IMPACT BITS

- Designed for higher torsion
- For use with 1/4" hex drive bit holders and accessories
- Designed for use with ROB recessed heads on screws and fastenings with a square hole

ITEM ID	Size mm	Drive	Pack Qty	Length mm
ROBP3000101	ROB1	1/4" Hex	1	30
ROBP3000105	ROB1	1/4" Hex	5	30
ROBP3000201	ROB2	1/4" Hex	1	30
ROBP3000205	ROB2	1/4" Hex	5	30
ROBP5000101	ROB1	1/4" Hex	1	50
ROBP5000201	ROB2	1/4" Hex	1	50
ROBP5000301	ROB3	1/4" Hex	1	50
ROBP8900101	ROB1	1/4" Hex	1	89
ROBP8900201	ROB2	1/4" Hex	1	89
ROBP8900301	ROB3	1/4" Hex	1	89



1/4" NUT SETTER

- For use with electric and rechargeable screwdrivers
- Suitable for use on ferrous fastenings

ITEM ID	Size mm	Drive	Type	Length mm
NS45108M	1/4"	1/4" Hex	Magnetic	45
NS45506M	6mm	1/4" Hex	Magnetic	45
NS45507M	7mm	1/4" Hex	Magnetic	45
NS45508M	8mm	1/4" Hex	Magnetic	45
NS45508R	8mm	1/4" Hex	Ring	45



1/4" IMPACT NUT SETTER

- 1/4" hexagon drive nut setter
- Designed for higher torsion enabling use with power tools such as electric and rechargeable screwdrivers
- Includes a magnet for holding the fastening
- Suitable for use on ferrous fastenings

ITEM ID	Size mm	Drive	Type	Length mm
NSP65I08	1/4"	1/4" Hex	Magnetic	65
NSP65S07	7mm	1/4" Hex	Magnetic	65
NSP65S08	8mm	1/4" Hex	Magnetic	65
NSP65S10	10mm	1/4" Hex	Magnetic	65
NSP65S13	13mm	1/4" Hex	Magnetic	65



1/4" MAGNETIC BIT HOLDER

- Bits holders with magnetic fittings

ITEM ID	Size mm	Holder	Length mm
ACC50MBH01	1/4" Hex	Magnetic	50
ACC70MBH01	1/4" Hex	Magnetic	70
ACC35CBH01	1/4" Hex	Chuck	35
ACC50CBH01	1/4" Hex	Chuck	50



1/4" MAGNETIC IMPACT BIT HOLDER

- S2 stainless steel for use with 1/4" hex drive impact bits
- Overall length 60mm to reach in to hard to reach places
- Recessed magnet holds the bit as well as fastenings (ferrous materials only)
- Designed for higher torsion

Item ID: **MBH114**



1/4" QUICK CHUCK IMPACT BIT HOLDER

- S2 stainless steel for use with 1/4" hex drive impact bits
- Overall length 60mm to reach in to hard to reach places
- Quick chuck bit holder for quick and easy changing between bits
- Designed for higher torsion

Item ID: **QC114**



1/4" IMPACT BIT ADAPTOR

- 1/4" hexagon drive to 1/4" square drive impact adaptor
- Overall length 50mm to enable access in to recesses
- Enables the use of 1/4" hexagon drive bit drivers with 1/4" drive impact sockets
- Designed for use with power tools such as electric and rechargeable screwdrivers
- Ball bearing socket retainer on the male end to securely grip the socket

ITEM ID:	Length mm	Depth mm	Height mm	Weight g
IBA14	50	8	8	15



1/4" BITS DRIVER EXTENSION

- Fixed shaft with quick chuck bits holder
- Rotating collar to lock or unlock the grip on the bit
- Ideal for use in hard to reach places

ITEM ID	Drive	Extension	Length	
			mm	AF
TTMD74-1	1/4" Hex	Fixed	100	4"



1/4" FLEXIBLE BITS DRIVER EXTENSION

- Flexible wound spring shaft with quick chuck bits holder
- Rotating collar to lock or unlock the grip on the bit
- Ideal for use in hard to reach places

ITEM ID	Drive	Extension	Length	
			mm	AF
TTMD74-2	1/4" Hex	Flexible	150	6"



1/4" FLEXIBLE BIT HOLDER

- Flexible wound spring shaft with quick chuck bits holder
- Ideal for use in hard to reach places

ITEM ID	Drive	Extension	Length	
			mm	AF
ACC300CBH01	1/4" Hex	Flexible	300	12"



1/4" BIT ADAPTOR MALE

- Adaptor from a 1/4" hex drive to a square socket drive
- Suitable for use with electric and rechargeable screwdrivers
- For use with standard and impact type sockets
- Ball bearing socket retainer on the male end to securely grip the socket

ITEM ID	Hex Drive	Square Drive	Length
			mm
ACCSDA1414	1/4" Hex	1/4"	50
ACCSDA1438	1/4" Hex	3/8"	50
ACCSDA1412	1/4" Hex	1/2"	50



COUPLER ADAPTORS

- Coupler adaptors for holding various bits
- Chrome vanadium
- Satin finish for a better grip when handling the adaptor
- Retaining spring to hold the bit in place
- Designed and manufactured to DIN ISO 1173
- Supplied with a metal socket clip for use with a socket rail

ITEM ID	Drive	Converts to	Weight
			g
M140060-C	1/4"	1/4" Hex Bits	20
M380060-C	3/8"	1/4" Hex Bits	32
M380061-C	3/8"	10mm Hex Bits	32
M120060-C	1/2"	5/16" Hex Bits	88
M120061-C	1/2"	10mm Hex Bits	56
M120062-C	1/2"	12mm Hex Bits	62
M120063-C	1/2"	1/4" Hex Bits	88



1/4"

1/4" MINI BITS RATCHET 60 TEETH

- 1/4" hex drive reversible bits ratchet
- Overall length 90mm making it very compact and easy to keep in the pocket
- Flip reverse mechanism for quickly changing between tightening and loosening
- Chrome vanadium satin finish drop forged steel
- For use with 1/4" drive hex bits
- 8mm double hexagon ring spanner on the other end

Item ID: 1400B



1/4"

1/4" RATCHET HEAD HEX

- Fine tooth mini ratchet head
- Designed for use together with any 1/4" hex drive bit holder
- 1/4" square drive for use with sockets and accessories
- 1/4" hexagon drive for use with screwdriver bits and accessories
- 72 teeth for use in confined spaces
- Flip reverse for quickly and easily changing between tightening and loosening
- Designed and manufactured to DIN3122D

Item ID: RHA14



7 Pieces

3/8"

1/4" BIT SET WITH 3/8" COUPLER TX 7 PIECES

- 3/8" drive bit holder/coupler
- 6 TX bits held in a "bullet holder" to avoid losing the bits

3/8" Drive x 1/4" Hex coupler

1/4" Hex Bits:

Length 25mm TX10, TX15, TX20, TX25, TX30, TX40

Item ID: 1486



4 Pieces

1/2"

5/16" BIT SET WITH 1/2" COUPLER TX 4 PIECES

- 1/2" drive bit holder/coupler
- 3 TX bits held in a "bullet holder" to avoid losing the bits

1/2" Drive x 5/16" Hex coupler

5/16" Hex Bits:

Length 25mm TX45, TX50, TX55

Item ID: 1488



10 Pieces

1/4"

1/4" BIT SET WITH 1/4" COUPLER IPR 10 PIECES

- For use with 5-wing fastenings with a tamper proof hole
- 1/4" drive bit holder/coupler
- Bits held in a "bullet holder" to avoid losing the bits

1/4" Drive x 1/4" Hex coupler

1/4" Hex Bits:

Length 25mm IPR10, IPR15, IPR20, IPR25, IPR27, IPR30, IPR40, IPR45, IPR50

Item ID: M1410T5

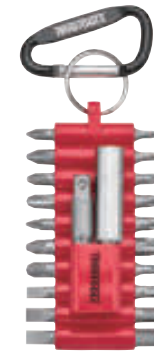

22 Pieces

HOOK ON BIT SET MIXED 22 PIECES

- Bit holder with a clip ring for use on a belt or with a safety wire if working at height
- Includes 20 assorted 25mm length bits together with a 60mm magnetic bit holder
- A 1/4" drive adaptor for use with 1/4" drive sockets and accessories

60mm magnetic bit holder, 1/4" Hex x 1/4"M adaptor

1/4" Hex Bits:	+	PZ1, PZ2, PZ3	+	PH1, PH2, PH3	+	PH2G
Length 25mm	+	TX10, TX15, TX20, TX25, TX30, TX40	+	3, 4, 5, 6	-	4.5, 5.5, 6.5 mm

Item ID: THBS22

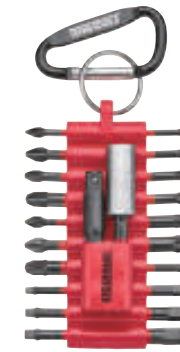

22 Pieces

HOOK ON IMPACT BIT SET MIXED 22 PIECES

- A handy bit holder with a clip ring for use on a belt or safety wire if working at height
- Includes 20 assorted 30mm length impact bits together with a 60mm magnetic bit holder
- A 1/4" drive adaptor for use with 1/4" drive impact sockets
- Designed for higher torsion enabling use with power tools

60mm Impact magnetic bit holder, 1/4" Hex x 1/4"M adaptor

1/4" Hex	+	PZ1, PZ2, PZ3	+	PH1, PH2, PH3	+	PH2G
Impact Bits:	+	TX10, TX15, TX20, TX25, TX30, TX40	+	3, 4, 5, 6	+	1, 2, 3
Length 30mm						

Item ID: THBSI22





TT
SERIES

53
Pieces

1/4"

IMPACT BIT SET TTI 53 PIECES

- Screwdriver, hex and TX bits in various lengths
- Metric and AF impact nut setters included
- New design impact bits and adaptors for higher torsion
- Suitable for use with power tools

60mm Impact magnetic bit holder,
60mm Impact quick chuck bit holder

1/4" Drive Impact nut setters - Length 65mm

Size: 1/4" 8 10 13

1/4" Hex Impact Bits: PH1, PH2 (x2), PH3 PH2G (x2) 1, 2
Length 30mm PZ1, PZ2 (x2), PZ3 3, 4 (x2), 5, 6

TX10, TX15, TX20 (x2), TX25 (x2),
TX27, TX30 (x2), TX40

1/4" Hex Impact Bits: TX10, TX15, TX20, TX25,
TX27, TX30, TX40
3, 4, 5, 6 PH2G 1, 2, 3 PZ2

1/4" Hex Impact Bits: TX20, TX25, TX30 PH2 (x2)
Length 89mm

Item ID: **TTBS53**



FOAM
SERIES

50
Pieces

IMPACT BIT SET FOAM1 50 PIECES

- Magnetic and quick chuck bit holders included for fast changing
- Designed for higher torsion
- Tools are held in place using three colour pre-cut EVA foam

60mm Impact magnetic bit holder,
60mm Impact quick chuck bit holder

1/4" Hex Impact Bits: PH1, PH2 (x2), PH3 PH2G (x2)
Length 30mm PZ1, PZ2 (x2), PZ3 3, 4 (x2), 5, 6

TX10, TX15, TX20 (x2), TX25 (x2),
TX27, TX30 (x2), TX40

1/4" Hex Impact Bits: PH1, PH2, PH3 3, 4, 5, 6
Length 50mm PZ1, PZ2, PZ3 1, 2, 3 PH2G
TX10, TX15, TX20, TX25, TX27, TX30, TX40

Item ID: **TEABS50**

NEW



TT
SERIES

Store x4 of these sets in a TCI Tray



28
Pieces

BIT SET WITH BELT CLIP MIXED 28 PIECES

- This set contains 26 of the most common 25mm bits together with a quick release bit holder and a 1/4" hex adaptor.
- Supplied in the unique TengTools TJ tray
- Clear fold up lid to see which set you need to use
- Sliding catch to secure the set when not in use

50mm quick release bit holder, 1/4" Hex x 1/4" Square drive adaptor

1/4" Drive Hex Bits:

Length 25 mm: 4,5, 5,5, 6,5 4, 5, 6 1, 2, 3
PH1, PH2, PH3 PZ1, PZ2, PZ3 PH2G (x2)
TX10, TX15, TX20, TX25, TX30, TX40
TPX20, TPX25, TPX30

Item ID: **TJ028**



TT
SERIES

Store x4 of these sets in a TCI Tray



29
Pieces

BIT SET WITH BELT CLIP MIXED 29 PIECES

- Bit set that fits into the TTTJ04 tool tray allowing you to store 4 TJ sets in a single tray
- 1/4" drive bits ratchet and magnetic bits holder
- A selection of 25mm bits

50mm quick release bit holder, 1/4" Hex x 1/4" Square drive adaptor

1/4" Drive Hex Bits:

Length 25 mm: 3,5, 5,5, 8 2, 3, 4, 5, 6, 8 1, 2, 3
PH1, PH2, PH3 PZ1, PZ2, PZ3
TX10, TX15, TX20, TX25, TX30, TX40
TPX20, TPX25, TPX30

Item ID: **TJ1429**



TT
SERIES

Store x4 of these sets in a TCI Tray



29
Pieces

IMPACT BIT SET WITH BELT CLIP MIXED

- Bit set that fits into the TTTJ04 tool tray allowing you to store 4 TJ sets in a single tray
- Impact magnetic bits holder and impact quick chuck
- A selection of 30mm impact bits

60mm magnetic impact bit holder,
60mm quick chuck impact bits holder

1/4" Drive Impact Hex Bits:

Length 30 mm: PH1, PH2, PH3 PZ1, PZ2, PZ3 1, 2
PH2G 3, 4 (x2), 5, 6
TX10, TX15, TX20 (x2), TX25 (x2), TX27, TX30 (x2)

Item ID: **TJ1430**



TT
SERIES

Store x4 of these sets in a TCI Tray



12
Pieces

IMPACT BIT SET CONSTRUCTION WITH BELT CLIP

- Bit set that fits into the TTTJ04 tool tray allowing you to store 4 TJ sets in a single tray
- 60mm magnetic bits holder
- A selection of 30mm impact bits

60mm magnetic impact bit holder

1/4" Drive Impact Hex Bits:

Length 30 mm: PH1, PH2, PH3 PH2G 1, 2
TX10, TX20, TX25, TX30

Item ID: **TJ1412**



IMPACT BIT SET WITH BELT CLIP MIXED

- Bit set that fits into the TTTJ04 tool tray allowing you to store 4 TJ sets in a single tray
- 60mm magnetic bits holder
- A selection of 30mm impact bits

60mm magnetic impact bit holder	
1/4" Drive Impact Hex Bits:	
Length 30 mm:	3, 4, 5 PH2G 1, 2 PZ1, PZ2 TX20, TX25, TX30

Item ID: **TJ1413**



IMPACT BIT SET WITH BELT CLIP TX

- Bit set that fits into the TTTJ04 tool tray allowing you to store 4 TJ sets in a single tray
- 60mm magnetic bits holder
- A selection of 30mm impact TX bits

60mm magnetic impact bit holder	
1/4" Drive Impact Hex Bits:	
Length 30 mm	TX10, TX15, TX20 (x3), TX25 (x2), TX27, TX30 (x2), TX40

Item ID: **TJ1414**



IMPACT NUT SETTER SET WITH BELT CLIP

- Bit set that fits into the TTTJ04 tool tray allowing you to store 4 TJ sets in a single tray
- Includes a magnet for holding the fastening
- Suitable for use on ferrous fastenings

Impact Nut Setters:	
Length 65 mm	1/4" 7, 8, 10, 13 mm

Item ID: **TJNS05**



1/4" SOCKET SET 6 PT 19 PIECES

- Regular 6 point single hexagon sockets for a better grip
- Chrome vanadium satin finish sockets
- A selection of screwdriver and hex bits
- Supplied in the unique TengTools case with a snap lock
- Hard wearing hinge with a metal pin for longer life
- Designed and manufactured to DIN and ISO standards

1/4" Mini bits ratchet	
Magnetic bits holder, 1/4"M x 1/4" Hex adaptor	
Regular 6 point sockets:	
mm:	8 9 10 11 12 13 1/4" Hex bits: 4, 5, 5.5, 6.5 4, 5, 6 PH1, PH2 PZ1, PZ2

Item ID: **T1419**



1/4" SOCKET SET 6 PT 20 PIECES

- Regular 6 point single hexagon sockets for a better grip
- Chrome vanadium satin finish sockets
- A selection of screwdriver and TX bits
- Supplied in the unique TengTools case with a snap lock
- Hard wearing hinge with a metal pin for longer life
- Designed and manufactured to DIN and ISO standards

1/4" Mini bits ratchet	
Magnetic bits holder, 1/4"M x 1/4" Hex adaptor	
Regular 6 point sockets:	
mm:	5.5 6 7 8 9 10 13 1/4" Hex bits: 4.5, 5.5, 6.5 TX10, TX15, TX20 PH1, PH2 PZ1, PZ2

Item ID: **T1420**



BIT SET MIXED 29 PIECES

- 25mm long screwdriver, hex and TX bits to suit different applications
- Reversible mini bits ratchet
- Supplied a bits box with a click lock lid and small enough to easily fit in the pocket

50mm magnetic bit holder, 1/4" Hex x 1/4"M adaptor, 1/4" bits ratchet with 8mm ring spanner on one end	
1/4" Drive Hex Bits:	
Length 25 mm:	4, 5, 5.5, 6.5 4, 5, 6 1, 2, 3 PH1, PH2, PH3 PZ1, PZ2, PZ3 PH2G (x2) TX10, TX15, TX20, TX25, TX30, TX40 TPX20, TPX25, TPX30

Item ID: **TM029**



IMPACT BIT SET MIXED 10 PIECES

- New design impact bits and adaptors for higher torsion
- Suitable for use with impact power tools
- Supplied in the unique TengTools bits box with a click lock lid
- Small enough to easily fit in the pocket

60mm magnetic impact bit holder	
1/4" Drive Impact Hex Bits:	
Length 30 mm:	4, 5 PH2G 1, 2 PZ2 TX20, TX25, TX30

Item ID: **TM010**



10 Pieces

IMPACT BIT SET CONSTRUCTION MIXED

- 10 piece 1/4" hex impact bit set
- All the most commonly used impact bits for the construction industry
- New design impact bits and adaptors for higher torsion
- Suitable for use with impact power tools
- Supplied in the unique TengTools bits box with a click lock lid
- Small enough to easily fit in the pocket

60mm magnetic impact bit holder

1/4" Drive Impact Hex Bits:

Length 30 mm: PZ1, PZ2, PZ3 PH2 PH2G
 TX10, TX20, TX25, TX30

Item ID: TMC010



10 Pieces

IMPACT BIT SET TX 10 PIECES

- New design impact bits and adaptors for higher torsion
- Suitable for use with impact power tools
- Supplied in the unique TengTools bits box with a click lock lid
- Small enough to easily fit in the pocket

60mm magnetic impact bit holder

1/4" Drive Impact Hex Bits:

Length 30 mm TX10, TX15, TX20 (x2), TX25 (x2), TX27, TX30, TX40

Item ID: TMTX10



27 Pieces

IMPACT BIT SET MIXED 27 PIECES

- 27 piece impact bit set
- Designed for higher torsion
- Includes a comprehensive range of impact bits and accessories
- Supplied in the unique TengTools bits box
- A sliding lock system helps keep the contents secure

60mm Impact magnetic bit holder, 1/4" Hex x 1/4" M adaptor

1/4" Drive Impact nut setters - Length 65mm

Size: 1/4" 7 8 10

1/4" Hex PH1, PH2, PH3 3, 4, 5, 6
 Impact Bits: PZ1, PZ2, PZ3 PH2G
 Length 30mm TX10, TX15, TX20, TX25, TX40
 Length 89mm TX25, TX30 1, 2, 3

Item ID: TBBSI27



5 Pieces

IMPACT NUT SETTER SET 5 PIECES

- Designed for higher torsion
- Includes a magnet for holding the fastening
- Suitable for use on ferrous fastenings
- Supplied in the unique TengTools storage case
- A sliding lock system helps keep the contents secure

1/4" Drive Impact nut setters - Length 65mm:

Size: 1/4", 7, 8, 10, 13 mm

Item ID: TBNSI5



1/4" STUBBY BITS DRIVER

- Stubby handle ideal for use in confined spaces
- For use with any 1/4" hex drive bits
- Magnetic bit holder that holds the bit in place

Item ID: MDBH



1/4" MAGNETIC BITS DRIVER 193MM

- For use with any 1/4" hex drive bits
- Magnetic bit holder that holds the bit in place
- Overall length 193mm

Item ID: MD193



1/4" MAGNETIC BITS DRIVER 217MM

- For use with any 1/4" hex drive bits
- Magnetic bit holder that holds the bit in place
- Hex shape shaft for use with a wrench for extra torque
- Overall length 217mm

Item ID: MD216



1/4" LONG FLEXIBLE BITS DRIVER

- For use with any 1/4" hex drive bits
- Magnetic bit holder that holds the bit in place
- Flexible spring wound shaft for easier access in confined spaces
- Protected with a plastic sleeve that allows the driver to turn even when the shaft is gripped
- Overall length 555mm

Item ID: MD907FL



1/4" T HANDLE QUICK CHUCK BITS DRIVER

- T drive facility for extra torque
- For use with any 1/4" hex drive bits
- Quick chuck bit holder on the long end (overall length 130mm)
- Magnetic bit holder on the short end (overall length 75mm)

Item ID: MDTHQ



1/4" QUICK CHUCK BITS DRIVER 147MM

- For use with any 1/4" hex drive bits
- Quick chuck bit holder that holds the bit in place
- Overall length 147mm

Item ID: **MDQ147**



1/4" QUICK CHUCK BITS DRIVER 183MM

- For use with any 1/4" hex drive bits
- Quick chuck bit holder that holds the bit in place
- Overall length 183mm

Item ID: **MDQ183**



1/4" QUICK CHUCK BITS DRIVER 217MM

- For use with any 1/4" hex drive bits
- Quick chuck bit holder that holds the bit in place
- Hex shape shaft for use with a wrench for extra torque
- Overall length 217mm

Item ID: **MDQ217**



1/4" STUBBY BITS DRIVER SET 9 PIECES

- Stubby handle ideal for use in confined spaces
- Includes 8 of the most commonly used bits in a bullet style holder
- Magnetic bit holder that holds the bit in place

1/4" Hex Drive Bits:	
Length 25mm	6.5, 8 mm
	PH1, PH2
	PZ1, PZ2
	4, 5 mm

Item ID: **MD908N**



1/4" STUBBY RATCHETING BITS DRIVER SET

- Stubby handle ideal for use in confined spaces
- Forward, reverse and fixed settings
- 20 teeth ratchet mechanism for 18° increments between each click
- Includes 6 bits plus a 1/4" drive socket adaptor
- Bit storage inside the handle to avoid losing bits
- Magnetic bit holder that holds the bit in place

1/4" Hex x 1/4"M adaptor	
1/4" Hex Drive Bits:	
Length 25mm	5, 7 mm
	PH1, PH2
	PZ1, PZ2

Item ID: **MDR908S**



1/4" RATCHETING BITS DRIVER SET 8 PIECES

- Forward, reverse and fixed settings
- 20 teeth ratchet mechanism for 18° increments between each click
- Includes 6 bits plus a 1/4" drive socket adaptor
- Bit storage inside the handle to avoid losing bits
- Magnetic bit holder that holds the bit in place

1/4" Hex x 1/4"M adaptor	
1/4" Hex Drive Bits:	
Length 25mm	5, 7 mm
	PH1, PH2
	PZ1, PZ2

Item ID: **MDR908**



1/4" RATCHETING BITS DRIVER DOUBLE END BITS SET 8 PIECES

- Forward, reverse and fixed settings
- 20 teeth ratchet mechanism for 18° increments between each click
- 14 different screwdrivers in one
- Bit storage inside the handle to avoid losing bits
- Magnetic bit holder that holds the bit in place

1/4" Hex Drive Bits:	
Length 25mm	4 x 6 mm
	PH0 x PH3, PH1 x PH2
	PZ0 x PZ3, PZ1 x PZ2
	TX10 x TX15, TX20 x TX25

Item ID: **MDR915**



1/4" RATCHETING ANGLED BITS DRIVER SET

- Can be used straight or offset at up to 60° to create a pistol grip for added torque
- Forward, reverse and fixed settings
- 20 teeth ratchet mechanism for 18° increments between each click
- Includes 6 bits plus a 1/4" drive socket adaptor
- Bit storage inside the handle to avoid losing bits
- Quick chuck bit holder that holds the bit in place

1/4" Hex x 1/4"M adaptor	
1/4" Hex Drive Bits:	
Length 25mm	5, 7 mm
	PH1, PH2
	PZ1, PZ2

Item ID: **MDRT908**



1/4" RATCHETING QUICK CHUCK BITS DRIVER

- Forward, reverse and fixed settings
- 20 teeth ratchet mechanism for 18° increments
- Includes 6 bits plus a 1/4" drive socket adaptor
- Bit storage inside the handle to avoid losing bits
- Quick chuck bit holder that holds the bit in place

1/4" Hex x 1/4"M adaptor	
1/4" Hex Drive Bits:	
Length 25mm	5, 7 mm
	PH1, PH2
	PZ1, PZ2

Item ID: **MDRQ908**



TT SERIES
1

38 Pieces

BITS DRIVER SET TTI 38 PIECES

- An extensive range of 1/4" hex drive 25mm screwdriver bits
- 2 quick chuck magnetic bit driver handles included giving a choice of shaft lengths
- Removable lid and dove tail joints

147mm & 183mm Quick chuck screwdriver handles

1/4" Hex bits:

Length 25mm:	⊖ 3.5, 5.5, 8 mm	⊕ PH1, PH2, PH3
	⊕ PZ1, PZ2, PZ3	⊖ ROB1, 2, 3
	⊕ TX10, TX15, TX20, TX25, TX30, TX40	
	⊕ TPX20, TPX25, TPX30	
	⊖ 2, 3, 4, 5, 6, 8	
Length 89mm:	⊕ PH1, PH2	⊖ 3, 4 mm
	⊕ PZ1, PZ2	⊕ TX10, TX20, TX25

Item ID: **TTMDQ38**



TT SERIES
1

64 Pieces 1/4"

ANGLED RATCHETING BITS DRIVER SET TTI

- Comprehensive selection of 25mm 1/4" drive hex bits
- Ratcheting magnetic bits driver with an adjustable handle angle to create a pistol type grip driver
- Removable lid and dove tail joints

Bits driver with adjustable angle setting,
1/4" M x 1/4" hex coupler adaptor

1/4" Drive Regular 6 point sockets:

mm:	4, 5, 5.5, 6, 7, 8, 9, 10, 11, 12, 13 mm	
1/4" Hex bits:		
Length 25mm:	⊖ 3.5, 4, 4.5, 5, 5.5 (x2), 6.5, 7, 8 mm	⊕ PH2G (x3)
	⊕ PH1 (x4), PH2 (x4), PH3 (x2)	⊖ ROB1, 2, 3
	⊕ TX6, TX7, TX8, TX9, TX10, TX15, TX20 (x3), TX25 (x3), TX27, TX30, TX40	
	⊕ PZ1, PZ2 (x3), PZ3 (x2)	⊖ 2, 3, 4 (x3), 5, 6, 8

Item ID: **TTMDRT64**



TT SERIES
1

49 Pieces 1/4"

BITS DRIVER SET TTI 49 PIECES

- Comprehensive selection of 25mm and 89mm 1/4" drive hex bits
- 1/4" drive regular sockets from 4 to 13mm
- Various drivers and accessories for use with bits and/or sockets

147mm Quick chuck driver, 1/4" drive ratchet head adaptor,
1/4" M x 1/4" Hex adaptor

1/4" Drive Regular 6 point sockets:

mm:	4, 5, 5.5, 6, 7, 8, 9, 10, 11, 12, 13 mm	
1/4" Hex bits:		
Length 25mm:	⊖ 3.5, 5.5, 8 mm	⊕ PZ1, PZ2, PZ3
	⊕ PH1, PH2, PH3	⊖ 2, 3, 4, 5, 6, 8
	⊕ TX10, TX15, TX20, TX25, TX30, TX40	
	⊕ TPX20, TPX25, TPX30	⊖ ROB1, 2, 3
Length 89mm:	⊕ PH1, PH2	⊖ 4 mm
	⊕ TX10, TX20, TX25	⊕ PZ2
		⊖ 4 mm

Item ID: **TTMDQ49**



TT SERIES
1

62 Pieces 1/4"

T-HANDLE BITS DRIVER SET TTI 62 PIECES

- Comprehensive selection of 25mm 1/4" drive hex bits included
- T-handle bits driver with quick chuck adaptor on the long end and a magnetic bits holder on the short end

75mm Quick chuck T handle, 1/4" M x 1/4" Hex adaptor

1/4" Drive Regular 6 point sockets:

mm:	5, 5.5, 6, 7, 8, 9, 10, 11, 12, 13 mm	
1/4" Drive TX-E bit sockets:		
TX-E:	E4, E5, E6, E7, E8	
1/4" Hex bits:		
Length 25mm:	⊖ 3.5, 5.5, 8 mm	⊕ PZ1, PZ2, PZ3
	⊕ PH1, PH2, PH3	⊖ 2, 3, 4, 5, 6, 8
	⊕ TX6, TX7, TX8, TX9, TX10, TX15, TX20 (x3), TX25 (x3), TX27, TX30, TX40	
	⊕ TPX10, TPX15, TPX20 (x2), TPX25 (x2), TPX27, TPX30, TPX40	
	⊕ PH2G (x3)	⊖ ROB1, 2, 3

Item ID: **TTTHQ62**



TT SERIES
1

74 Pieces

RATCHETING SCREWDRIVER BIT SET TTI

- An extensive range of 1/4" hex drive 25mm screwdriver bits
- Reversible, magnetic, ratcheting bits driver, extension bars and adaptors included
- Removable lid and dove tail joints

Ratcheting bits handle, 6" flexible extension, 4" extension,
1/4" M x 1/4" hex coupler adaptor, 1/4" F:1/4" hex coupler adaptor

1/4" Hex bits:

Length 25mm:	⊖ 3.5, 4.0, 4.5, 5, 5.5 (x2), 6.5, 7, 8 mm	⊕ PH2G
	⊕ PH1 (x4), PH2 (x7), PH3	⊖ ROB1, 2, 3
	⊕ TX6, TX7, TX8, TX9, TX10, TX15, TX20 (x3), TX25 (x3), TX27, TX30, TX40	
	⊕ TPX10, TPX15, TPX20 (x2), TPX25 (x2), TPX27, TPX30, TPX40	
	⊕ PZ1 (x4), PZ2 (x7), PZ3	⊖ 2, 3, 4, 5, 6, 8

Item ID: **TTMD74**



TT SERIES
1

76 Pieces 1/4"

BITS DRIVER SET TTI 76 PIECES

- Quick chuck magnetic bits driver and adaptor for use with bits and/or sockets

217mm Quick chuck screwdriver handle, 1/4" M x 1/4" Hex adaptor

1/4" Drive Regular 6 point sockets:

mm:	4, 5, 5.5, 6, 7, 8, 9, 10, 11, 12, 13 mm	
1/4" Hex bits:		
Length 25mm:	⊖ 3.5, 4.0, 4.5, 5.5 (x2), 6.5, 8.0 mm	⊕ PH2G (x3)
	⊕ PH1 (x3), PH2 (x6), PH3	⊖ ROB1, 2, 3
	⊕ TX6, TX7, TX8, TX9, TX10, TX15, TX20 (x3), TX25 (x3), TX27, TX30, TX40	
	⊕ TPX10, TPX15, TPX20 (x2), TPX25 (x2), TPX27, TPX30, TPX40	
	⊕ PZ1 (x3), PZ2 (x6), PZ3	⊖ 2, 3, 4, 5, 6, 8

Item ID: **TTMDQ76**



TT
SERIES
1

84
Pieces 1/4"

RATCHETING BITS DRIVER SET TTI 84 PIECES

- Reversible ratcheting bits driver, flexible extension and adaptor for use with bits and/or sockets

Ratcheting Quick chuck screwdriver handle, 1/4" M x 1/4" Hex adaptor, 150mm flexible extension bar

1/4" Drive Regular 6 point sockets:

mm: 4, 5, 5.5, 6, 7, 8, 9, 10, 11, 12, 13 mm

1/4" Hex bits:

- | | | |
|--------------|--|--------------------|
| Length 25mm: | ⊖ 3.5, 4.0, 4.5, 5.5 (x2), 6.5, 8.0 mm | ⊕ PH2G (x3) |
| | ⊕ PH1 (x3), PH2 (x6), PH3 | ⊖ ROB1, 2, 3 |
| | ⊕ TX6, TX7, TX8, TX9, TX10, TX15, TX20 (x3), TX25 (x3), TX27, TX30, TX40 | |
| | ⊕ TPX10, TPX15, TPX20 (x2), TPX25 (x2), TPX27, TPX30, TPX40 | |
| | ⊕ PZ1 (x3), PZ2 (x6), PZ3 | ⊖ 2, 3, 4, 5, 6, 8 |

Item ID: **TTMDR84**



TT
SERIES
x4

41
Pieces 1/4"

SOCKET & BIT SET FLEXIBLE HANDLE TTX4

- Long reach bit and socket drivers set
- Comprehensive selection of 25mm 1/4" drive hex bits
- 1/4" drive regular sockets from 4 to 13mm
- Ideal for use in difficult to reach places

555mm flexible spinner handle with 1/4" drive, 555mm flexible bits driver with 1/4" hex drive, 1/4" M x 1/4" hex coupler adaptor

1/4" Drive Regular 6 point sockets:

mm: 4, 4.5, 5, 5.5, 6, 7, 8, 9, 10, 11, 12, 13 mm

1/4" Hex bits:

- | | | |
|--------------|---|---------------------|
| Length 25mm: | ⊖ 4, 5.5, 8 mm | ⊕ 3, 4, 5, 6, 8, 10 |
| | ⊕ PH0, PH1, PH2, PH3, PH4 | |
| | ⊕ PZ0, PZ1, PZ2, PZ3 | |
| | ⊕ TX8, TX10, TX15, TX20, TX25, TX27, TX30, TX40 | |

Item ID: **TTXMD41N**



FOAM
SERIES
1

78
Pieces 1/4"

BITS DRIVER SET FOAM1 78 PIECES

- Various drivers and accessories for use with bits and/or sockets
- Includes the TengTools mini bits ratchet adaptor for use with the quick chuck bits driver to create a reversible 1/4" drive ratchet
- Tools are held in place using three colour pre-cut EVA foam

147mm Quick chuck driver, 1/4" drive ratchet head adaptor, 1/4" M x 1/4" Hex adaptor, 50mm Bit holder

1/4" Drive Regular 6 point sockets:

mm: 4, 5, 5.5, 6, 7, 8, 9, 10, 11, 12, 13 mm

1/4" Hex bits:

- | | | |
|--------------|--|--------------------|
| Length 25mm: | ⊖ 3.5, 4.0, 4.5, 5.5 (x2), 6.5, 8.0 mm | ⊕ PH2G (x3) |
| | ⊕ PH1 (x3), PH2 (x6), PH3 | ⊖ ROB1, 2, 3 |
| | ⊕ TX6, TX7, TX8, TX9, TX10, TX15, TX20 (x3), TX25 (x3), TX27, TX30, TX40 | |
| | ⊕ TPX10, TPX15, TPX20 (x2), TPX25 (x2), TPX27, TPX30, TPX40 | |
| | ⊕ PZ1 (x3), PZ2 (x6), PZ3 | ⊖ 2, 3, 4, 5, 6, 8 |

Item ID: **TEAMDQ78**



6
Pieces 1/2"

1/2" & 5/16" IMPACT DRIVER SET 6 PIECES

- Reversible action impact driver for shifting stubborn fastenings
- 1/2" drive square drive for use with impact sockets and accessories
- Removable bit holder included for use with 5/16" hexagon drive impact bits
- Set includes four impact bits covering the most popular screw head sizes and types
- Supplied in a handy storage case

Reversible impact driver, coupler adaptor

5/16" Hex bits: Length 36mm ⊖ 8, 10 ⊕ PH2, PH3

Item ID: **ID506**



4
Pieces

5/16" IMPACT BIT SET MIXED 4 PIECES

- Spare bits for the ID506 impact driver

5/16" Hex bits: Length 36mm ⊖ 8, 10 ⊕ PH2, PH3

Item ID: **ID506BIT**



15
Pieces 1/2"

1/2" & 5/16" IMPACT DRIVER SET 15 PIECES

- Reversible action heavy duty impact driver for shifting stubborn fastenings
- 1/2" drive square drive for use with impact sockets and accessories
- Removable bit holder included for use with 5/16" hexagon drive impact bits
- Set includes 12 impact bits covering the most popular screw head sizes and types
- Supplied in a handy storage case

Heavy duty reversible impact driver, coupler adaptor, 5/16" Hex x 3/8" M adaptor

5/16" Hex bits: Length 36mm ⊖ 6, 8, 10, 12 ⊕ PH1, PH2, PH3, PH4
⊖ 4, 5, 6, 8

Item ID: **ID515**



13
Pieces

5/16" IMPACT BIT SET MIXED 13 PIECES

- Spare bits for the ID515 impact driver

5/16" Hex x 3/8" M adaptor

5/16" Hex bits: Length 36mm ⊖ 6, 8, 10, 12 ⊕ PH1, PH2, PH3, PH4
⊖ 4, 5, 6, 8

Item ID: **ID515BIT**



5/16" HEX IMPACT BITS

- 5/16" hexagon drive impact bits
- For use with 1/2" drive impact drivers
- Designed for use with fastenings with a hexagon hole
- Use with in-hex screws or grub screws

ITEM ID:	Drive	Description	Length mm
910504	5/16" hex	4mm hex impact bit	36
910505	5/16" hex	5mm hex impact bit	36
910506	5/16" hex	6mm hex impact bit	36
910508	5/16" hex	8mm hex impact bit	36
910510	5/16" hex	10mm hex impact bit	36
920001	5/16" hex	PZ1 impact bit	36
920002	5/16" hex	PZ2 impact bit	36
920003	5/16" hex	PZ3 impact bit	36
940006	5/16" hex	6mm flat impact bit	36
940008	5/16" hex	8mm flat impact bit	36
940010	5/16" hex	10mm flat impact bit	36
940012	5/16" hex	12mm flat impact bit	36
930001	5/16" hex	PH1 impact bit	36
930002	5/16" hex	PH2 impact bit	36
930003	5/16" hex	PH3 impact bit	36
930004	5/16" hex	PH4 impact bit	36
970030	5/16" hex	TX30 impact bit	36
970040	5/16" hex	TX40 impact bit	36
970045	5/16" hex	TX45 impact bit	36
970050	5/16" hex	TX50 impact bit	36
970055	5/16" hex	TX55 impact bit	36



7 Pieces 1/4"

1/4" IMPACT DRIVER SET 7 PIECES

- For use with 1/4" hexagon drive impact bits
- Supplied complete with the most popular screwdriver head sizes and types
- Screw extractor bits also included for removing damaged fastenings
- Bits are held in a handy "bullet holder" for safe storage

1/4" Drive reversible impact driver			
Screw Extractors:	1	2	3
1/4" Hex Impact Bits:	PH1, PH2		5mm
Length 50mm			

Item ID: **IDSE7**



TT SERIES 19 Pieces 1/4"

1/4" IMPACT DRIVER SET TT1 19 PIECES

- Includes a range of impact bits, impact sockets and screw extractors
- A complete set for removing stubborn fastenings

1/4" Drive reversible impact driver, Impact Bit Adaptor, 1/4" Hex x 1/4"M adaptor			
1/4" Drive Impact 6 point sockets:			
Reg mm:	8	10	13
Screw Extractors:	1	2	3
1/4" Hex Impact Bits:	3, 4, 5, 6	TX25, TX30, TX40	
Length 50mm	PH2, PH3	PZ2, PZ3	

Item ID: **TTID19**



TT SERIES 20 Pieces 1/2"

1/2" IMPACT DRIVER SET TT1 20 PIECES

- Includes a range of impact bits for removing stubborn fastenings

Reversible impact driver, coupler adaptor, 5/16" Hex x 1/2"M adaptor			
5/16" Hex bits:	6, 8, 10, 12	PH1, PH2, PH3, PH4	
Length 36mm	4, 5, 6, 8	TX30, TX40, TX45, TX50, TX55	

Item ID: **TTID20**



Impact Drivers & Bits

There is nothing more frustrating than wasting time and effort trying to loosen a stuck nut or bolt. Hand impact drivers are simple tools that work amazingly well for this task. Compared to a power impact tool there is far greater control with these models, they give greater access and they are so easy to use. If you can hold the tool and swing a hammer, then you can use this affordable impact tool!

After inserting the correct impact bit into the impact driver engage the stubborn screw or bolt. Apply downward pressure, while at the same time attempting to turn the impact driver in the direction you want the screw or nut to turn. Now the fun part! Whack the top of the impact driver with a hammer until the screw or nut is loosened enough to use a faster tool, such as a socket and a ratchet.



FOAM SERIES 95 Pieces 1/4"

TORQUE SCREWDRIVER SET FOAM2

- 1-5 Nm torque screwdriver with accessories
- Accurate to +/- 6% and conforms to ISO6789 for assured accuracy
- Ratcheting bits driver set included
- Supplied in the unique TengTools FOAM2 tray
- Tools are held in place using three colour pre-cut EVA foam clearly showing where each tool belongs

1/4" Drive	1-5 Nm Torque screwdriver, Quick release chuck, Sliding T-bar, 6" Flexible extension, Ratcheting bits driver with assorted bits, 1/4"M x 1/4" hex adaptor		
1/2" Drive	1/2"M x 5/16" Hex adaptor, Reversible impact driver, 5/16" Hex bit adaptor		
5/16" Hex bits:	TX30, TX40, TX45, TX50, TX55	6, 8, 10, 12	
Length 36mm	PH1, PH2, PH3, PH4	4, 5, 6, 8	
1/4" Hex bits:	3.5, 4, 4.5, 5.5 (x2), 6.5, 8	1, 2, 3	
Length 25mm	PZ1 (x3), PZ2 (x6), PZ3	2, 3, 4, 5, 6, 8	
	PH1 (x3), PH2 (x6), PH3	PH2C (x3)	
	TX6, TX7, TX8, TX9, TX10, TX15, TX20 (x3), TX25 (x3), TX27, TX30, TX40		
	TPX10, TPX15, TPX20 (x2), TPX25 (x2), TPX27, TPX30, TPX40		

Item ID: **TEDSD14**

HEX & TX KEYS

VERSATILE, STRONG AND DURABLE

TengTools wide range of hex & TX keys consists of a range of keys made of chrome vanadium steel for industrial use and a series made of chrome-molybdenum for heavy duty usage.



CHROME VANADIUM STEEL

Stronger, harder and more durable than regular carbon steels. This guarantees the high level of quality that you would expect from a TengTools item

Our cases are designed to hold the wrenches tight enough so they didn't fall out but with a flexible enough grip that they were are still easily removed

For higher torque applications it is better to use the straight end Hex keys for maximum fastener engagement

Available in metric & imperial sizes up to 19mm or 1/2"



CHROME MOLYBDENUM STEEL

It is an alloy tool steel with chromium (Cr), molybdenum (Mo), iron (Fe) and carbon (C) alloy elements. The highest quality steel that we use. It is particularly hard and strong, but also has an amount of flex. Ideal to use when more torque is required.

Ballpoint heads are ideal for areas that are hard to reach. Fastenings can be turned at an angle of 25° in a Hex or TX key.





HEX KEY METRIC

- Metric hexagon key wrench
- Individually marked for size
- Ground key ends for a better finish and accurate fit
- Manufactured in chrome vanadium steel with a black phosphate finish
- Designed and manufactured to DIN 2936

ITEM ID:	Size mm	Short Arm Length mm	Long Arm Length mm
3105007	0.7	8	35
3105009	0.9	10	38
3105013	1.3	12	41
3105015	1.5	14	45
310502	2	16	50
3105025	2.5	18	56
310503	3	20	63
310504	4	25	70
3105045	4.5	26	75
310505	5	28	80
3105055	5.5	30	85
310506	6	32	90
310507	7	34	95
310508	8	36	100
310509	9	38	106
310510	10	40	112
310511	11	42	118
310512	12	45	125
310514	14	56	140
310516	16	60	152
310517	17	63	160
310518	18	66	159
310519	19	70	180
310522	22	80	200
310527	27	100	250
310532	32	125	315
310536	36	140	355



HEX KEY AF

- Individually marked for size
- Ground key ends for a better finish and accurate fit
- Manufactured in chrome vanadium steel with a black phosphate finish
- Designed and manufactured to ASME B18.3

ITEM ID:	Size AF	Short Arm Length mm	Long Arm Length mm
310102	1/16"	14	44
3101025	5/64"	15	48
310103	3/32"	17	51
3101035	7/64"	18	54
310104	1/8"	19	57
3101045	9/64"	20	60
310105	5/32"	21	64
310106	3/16"	24	70
310107	7/32"	26	76
310108	1/4"	28	83
310110	5/16"	32	95
310112	3/8"	35	108
310114	7/16"	38	121
310116	1/2"	41	133
310120	5/8"	48	159



EXTRA LONG HEX KEY METRIC

- Extra long metric hexagon key wrench
- Individually marked for size
- Manufactured in chrome vanadium steel with a black phosphate finish

ITEM ID:	Size mm	Short Arm Length mm	Long Arm Length mm
3205015	1.5	14	90
320502	2	16	100
3205025	2.5	18	112
320503	3	20	126
320504	4	25	140
320505	5	28	160
320506	6	32	180
320508	8	36	200
320510	10	40	224

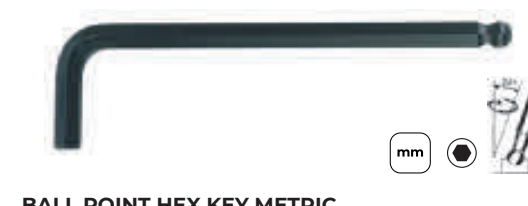

BALL POINT HEX KEY METRIC

- Ball point end on the long key end giving access at angles of up to 25°
- Ideal for use in confined spaces
- Regular hex end on the short arm giving the ability to apply higher torque
- Manufactured in chrome vanadium steel with a black phosphate finish

ITEM ID:	Size mm	Short Arm Length mm	Long Arm Length mm
3105015BL-C	1.5	14	77
310502BL-C	2	16	83
3105025BL-C	2.5	18	90
310503BL-C	3	20	98
310504BL-C	4	25	106
310505BL-C	5	28	118
310506BL-C	6	32	137
310507BL-C	7	34	147
310508BL-C	8	36	156
310510BL-C	10	40	170

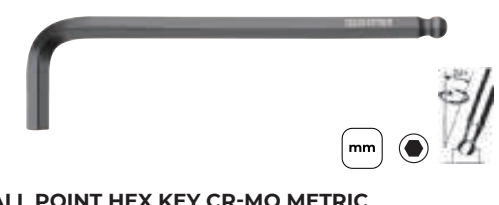

BALL POINT HEX KEY CR-MO METRIC

- Manufactured in Chrome molybdenum steel for added strength
- Ball point end on the long key end giving access at angles of up to 25°
- Ideal for use in confined spaces
- Regular hex end on the short arm giving the ability to apply higher torque
- Individually marked for size for easier identification

ITEM ID:	Size mm	Short Arm Length mm	Long Arm Length mm
3905015BL	1.5	14	77
390502BL	2	16	83
3905025BL	2.5	18	90
390503BL	3	20	98
390504BL	4	25	106
390505BL	5	28	118
390506BL	6	32	137
390508BL	8	36	156
390510BL	10	40	170



BALL POINT HEX KEY AF

- Ball point end on the long key end giving access at angles of up to 25°
- Ideal for use in confined spaces
- Regular hex end on the short arm giving the ability to apply higher torque
- Manufactured in chrome vanadium steel with a black phosphate finish

ITEM ID:	Size AF	Short Arm Length mm	Long Arm Length mm
3101025BL	5/64"	15	82
310103BL	3/32"	17	88
310104BL	1/8"	19	96
310105BL	5/32"	21	105
310106BL	3/16"	24	114
310107BL	7/32"	26	124
310108BL	1/4"	28	135
310110BL	5/16"	32	151
310112BL	3/8"	35	170



BALL POINT HEX KEY CR-MO AF

- Manufactured in Chrome molybdenum steel for added strength
- Ball point end on the long key end giving access at angles of up to 25°
- Ideal for use in confined spaces
- Regular hex end on the short arm giving the ability to apply higher torque
- Individually marked for size for easier identification of the right size wrench

ITEM ID:	Size AF	Short Arm Length mm	Long Arm Length mm
3901025BL	5/64"	15	82
390103BL	3/32"	17	88
390104BL	1/8"	19	96
390105BL	5/32"	21	105
390106BL	3/16"	24	114
390107BL	7/32"	26	124
390108BL	1/4"	28	135
390110BL	5/16"	32	151
390112BL	3/8"	35	170



T HANDLE BALL POINT HEX KEY METRIC

- Ball point end on the long key end giving access at angles of up to 25°
- Ideal for use in confined spaces
- Regular hex end on the short arm giving the ability to apply higher torque
- Manufactured in chrome molybdenum for extra strength
- Ergonomically designed bi-material handle for easy use with higher torque
- Hole in the handle for hanging or for use with a fall protection wire

ITEM ID:	Size mm	Short Arm Length mm	Long Arm Length mm
510502	2	12	100
5105025	2.5	12	100
510503	3	12	100
510504	4	12	100
510505	5	15	150
510506	6	15	150
510507	7	15	150
510508	8	18	190
510510	10	20	200
510512	12	20	200



T HANDLE HEX KEY METRIC

- Regular hex end on both arms giving the ability to apply higher torque
- Larger contact zone with the fastening reduces wear inside hexagon socket screws
- Manufactured in chrome molybdenum for extra strength
- Ergonomically designed bi-material handle for easy use with higher torque
- Hole in the handle for hanging or for use with a fall protection wire

ITEM ID:	Size mm	Short Arm Length mm	Long Arm Length mm
5106025	2.5	15	100
510603	3	15	100
510604	4	15	100
510605	5	18	150
510606	6	18	150
510607	7	18	150
510608	8	18	190





AF

T HANDLE BALL POINT HEX KEY AF

- Ball point end on the long key end giving access at angles of up to 25°
- Ideal for use in confined spaces
- Regular hex end on the short arm giving the ability to apply higher torque
- Manufactured in chrome molybdenum for extra strength
- Ergonomically designed bi-material handle for easy use with higher torque
- Hole in the handle for hanging or for use with a fall protection wire

ITEM ID:	Size AF	Short Arm Length mm	Long Arm Length mm
510103	3/32"	12	100
510104	1/8"	12	100
510105	5/32"	12	100
510106	3/16"	12	100
510107	7/32"	15	150
510108	1/4"	15	150
510110	5/16"	15	150



9 Pieces mm

HEX KEY SET 9 PIECES

- Regular hex end on both arms giving the ability to apply higher torque
- Chrome vanadium steel with a black finish
- Each key can be easily removed or used by simply twisting in it's individual holder
- Supplied with a folding plastic holder to keep the keys together

Hex Keys with Folding Plastic Holder:
 1.5, 2, 2.5, 3, 4, 5, 6, 8, 10 mm

Item ID: **1479MMR**



9 Pieces mm

EXTRA LONG HEX KEY SET 9 PIECES

- Regular hex end on both arms giving the ability to apply higher torque
- Chrome vanadium steel with a black finish
- Each key can be easily removed or used by simply twisting in it's individual holder
- Supplied with a folding plastic holder to keep the keys together

Hex Keys with Folding Plastic Holder:
 1.5, 2, 2.5, 3, 4, 5, 6, 8, 10 mm

Item ID: **1479MMRL**



7 Pieces mm

BALL POINT HEX KEY SET 7 PIECES

- Ball point end on the long key end giving access at angles of up to 25°
- Ideal for use in confined spaces
- Regular hex end on the short arm giving the ability to apply higher torque
- Chrome vanadium steel with a black finish
- Each key can be easily removed or used by simply twisting in it's individual holder
- Supplied with a plastic holder to keep the keys together

Hex Keys with Folding Plastic Holder:
 2.5, 3, 4, 5, 6, 8, 10 mm

Item ID: **1475**



9 Pieces mm

BALL POINT HEX KEY SET 9 PIECES

- Ball point end on the long key end giving access at angles of up to 25°
- Ideal for use in confined spaces
- Regular hex end on the short arm giving the ability to apply higher torque
- Chrome vanadium steel with a black finish
- Each key can be easily removed or used by simply twisting in it's individual holder
- Supplied with a folding plastic holder to keep the keys together

Hex Keys with Folding Plastic Holder:
 1.5, 2, 2.5, 3, 4, 5, 6, 8, 10 mm

Item ID: **1479MM**



9 Pieces mm

BALL POINT HEX KEY SET A 9 PIECES

- Includes 7mm, commonly used in automotive applications
- Ball point end on the long key end giving access at angles of up to 25°
- Ideal for use in confined spaces
- Regular hex end on the short arm giving the ability to apply higher torque
- Chrome vanadium steel with a black finish
- Each key can be easily removed or used by simply twisting in it's individual holder
- Supplied with a folding plastic holder to keep the keys together

Hex Keys with Folding Plastic Holder:
 1.5, 2, 2.5, 3, 4, 5, 6, 7, 10 mm

Item ID: **1479MMA**



9 Pieces mm

BALL POINT HEX KEY SET CR-MO 9 PIECES

- Chrome molybdenum steel for extra strength
- Ball point end on the long key end giving access at angles of up to 25°
- Ideal for use in confined spaces
- Regular hex end on the short arm giving the ability to apply higher torque
- Each key can be easily removed or used by simply twisting in it's individual holder
- Supplied with a folding plastic holder to keep the keys together

Hex Keys with Folding Plastic Holder:
 1.5, 2, 2.5, 3, 4, 5, 6, 7, 10 mm

Item ID: **1499MM**



7 Pieces AF

BALL POINT HEX KEY SET AF 7 PIECES

- Ball point end on the long key end giving access at angles of up to 25°
- Ideal for use in confined spaces
- Regular hex end on the short arm giving the ability to apply higher torque
- Chrome vanadium steel with a black finish
- Each key can be easily removed or used by simply twisting in it's individual holder
- Supplied with a plastic holder to keep the keys together

Hex Keys with Folding Plastic Holder:
 1/8", 5/32", 3/16", 7/32", 1/4", 5/16", 3/8"

Item ID: **1474**



9 Pieces AF

BALL POINT HEX KEY SET AF 9 PIECES

- Ball point end on the long key end giving access at angles of up to 25°
- Ideal for use in confined spaces
- Regular hex end on the short arm giving the ability to apply higher torque
- Chrome vanadium steel with a black finish
- Each key can be easily removed or used by simply twisting in it's individual holder
- Supplied with a folding plastic holder to keep the keys together

Hex Keys with Folding Plastic Holder:

5/64", 3/32", 1/8", 5/32", 3/16", 7/32", 1/4", 5/16", 3/8"

Item ID: **1479AF**

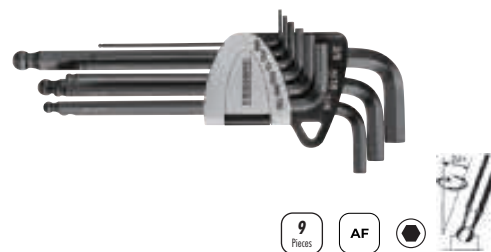

9 Pieces AF

BALL POINT HEX KEY SET CR-MO AF 9 PIECES

- Chrome molybdenum steel for extra strength
- Ball point end on the long key end giving access at angles of up to 25°
- Ideal for use in confined spaces
- Regular hex end on the short arm giving the ability to apply higher torque
- Each key can be easily removed or used by simply twisting in it's individual holder
- Supplied with a folding plastic holder to keep the keys together

Hex Keys with Folding Plastic Holder:

5/64", 3/32", 1/8", 5/32", 3/16", 7/32", 1/4", 5/16", 3/8"

Item ID: **1499AF**



7 Pieces mm

FOLDING HEX KEY SET 1.5-6 MM ALU 7 PIECES

- Chrome vanadium steel with a black finish
- Retractable keys held in a fold up aluminium holder
- Designed and manufactured to DIN2936

Hex Keys with Aluminium Holder:

1.5, 2, 2.5, 3, 4, 5, 6 mm

Item ID: **1476NMM**



7 Pieces mm

FOLDING HEX KEY SET 2.5-10 MM ALU 7 PIECES

- Chrome vanadium steel with a black finish
- Retractable keys held in a fold up aluminium holder
- Designed and manufactured to DIN2936

Hex Keys with Aluminium Holder:

2.5, 3, 4, 5, 6, 8, 10 mm

Item ID: **1476NMM1**



7 Pieces AF

FOLDING HEX KEY SET AF ALU 7 PIECES

- Chrome vanadium steel with a black finish
- Retractable keys held in a fold up aluminium holder
- Designed and manufactured to ASME B18.3

Hex Keys with Aluminium Holder:

1/16", 5/64", 3/32", 1/8", 5/32", 3/16", 7/32"

Item ID: **1476NAF**



7 Pieces mm

FOLDING HEX KEY SET 1.5-6 MM 7 PIECES

- Chrome vanadium steel with a black finish
- Retractable keys held in a fold up chromed holder
- Features a fold out ring connector for use with a safety wire for added security when working at heights

Hex Keys with Chromed Holder:

1.5, 2, 2.5, 3, 4, 5, 6 mm

Item ID: **1471MM**



7 Pieces mm

FOLDING HEX KEY SET 2.5-10 MM 7 PIECES

- Chrome vanadium steel with a black finish
- Retractable keys held in a fold up chromed holder
- Features a fold out ring connector for use with a safety wire for added security when working at heights

Hex Keys with Chromed Holder:

1.5, 2, 2.5, 3, 4, 5, 6 mm

Item ID: **1471MMA**



7 Pieces AF

FOLDING HEX KEY SET AF 7 PIECES

- Chrome vanadium steel with a black finish
- Retractable keys held in a fold up chromed holder
- Features a fold out ring connector for use with a safety wire for added security when working at heights

Hex Keys with Chromed Holder:

1/16", 5/64", 3/32", 1/8", 5/32", 3/16", 7/32"

Item ID: **1471AF**



7 Pieces AF

FOLDING HEX KEY SET AF 6 PIECES

- Chrome vanadium steel with a black finish
- Retractable keys held in a fold up chromed holder
- Features a fold out ring connector for use with a safety wire for added security when working at heights

Hex Keys with Chromed Holder:

1/8", 5/32", 3/16", 1/4", 5/16", 3/8"

Item ID: **1471AFA**



10 Pieces AF

HEX KEY SET AF 10 PIECES

- Chrome vanadium steel with a black finish
- Each key can be removed by simply unscrewing from it's individual holder
- Supplied on a ring to keep the keys together

Hex Keys with Ring Holder:

1/16", 5/64", 3/32", 1/8", 5/32", 3/16", 7/32", 1/4", 5/16", 3/8"

Item ID: **1424**



10 Pieces mm

HEX KEY SET 10 PIECES

- Chrome vanadium steel with a black finish
- Each key can be removed by simply unscrewing from it's individual holder
- Supplied on a ring to keep the keys together

Hex Keys with Ring Holder:

1.5, 2, 2.5, 3, 4, 5, 6, 7, 8, 10 mm

Item ID: **1425**



TT SERIES

1

7 Pieces mm

T-HANDLE BALL POINT HEX KEY SET TT1

- Ball point end on the long key end giving access at angles of up to 25°
- Regular hex end on the short arm gives the ability to apply higher torque
- Removable lid and dove tail joints

Ball Point T-Handle Hex Drivers:

100 mm long: 2.5, 3, 4 mm

150 mm long: 5, 6, 7 mm

190 mm long: 8 mm

Item ID: **TTHEX7**



TT SERIES

1

7 Pieces mm

T-HANDLE HEX KEY SET TTI 7 PIECES

- Regular hex end on the short and long arms gives the ability to apply higher torque
- Removable lid and dove tail joints

T-Handle Hex Drivers:

100 mm long: 2.5, 3, 4 mm

150 mm long: 5, 6, 7 mm

190 mm long: 8 mm

Item ID: **TTHEX7S**



TT SERIES

1

7 Pieces AF mm

T-HANDLE BALL POINT HEX KEY SET AF TT1

- Ball point end on the long key end giving access at angles of up to 25°
- Regular hex end on the short and long arms gives the ability to apply higher torque
- Removable lid and dove tail joints

Ball Point T-Handle Hex Drivers:

100 mm long: 3/32", 1/8", 5/32"

150 mm long: 3/16", 7/32", 1/4"

190 mm long: 5/16"

Item ID: **TTHEX7AF**



TT SERIES

1

28 Pieces mm AF

BALL POINT HEX & TX KEY SET TT1 28 PIECES

- Includes a range of ball point keys covering metric and AF hex key & TX keys
- Removable lid and dove tail joints

Ball Point Hex & TX Keys:

1.5, 2, 2.5, 3, 4, 5, 6, 7, 8, 10 mm

5/64", 3/32", 1/8", 5/32", 3/16", 7/32", 1/4", 5/16", 3/8"

TX8, TX9, TX10, TX15, TX20, TX25, TX27, TX30, TX40

Item ID: **TTHT28**



FOAM SERIES

2

7 Pieces mm

T-HANDLE BALL POINT HEX KEY SET FOAM2

- Ball point end on the long key end giving access at angles of up to 25°
- Regular hex end on the short arm giving the ability to apply higher torque
- Tools are held in place using three colour pre-cut EVA foam

Ball Point T-Handle Hex Drivers:

100 mm long: 2.5, 3, 4 mm

150 mm long: 5, 6, 7 mm

190 mm long: 8 mm

Item ID: **TEDHEX7**



FOAM SERIES
2

42 Pieces mm AF

BALL POINT HEX & TX KEY SET FOAM2

- Includes metric and inch hex keys
- TX keys and mini TX keys
- Also includes a handy fold up key set including hex, TX and screwdriver blades
- Tools are held in place using three colour pre-cut EVA foam

Ball Point Hex & TX Keys:

1.5, 2, 2.5, 3, 4, 5, 6, 7, 8, 10 mm

5/64", 3/32", 1/8", 5/32", 3/16", 7/32", 1/4", 5/16", 3/8"

TX8, TX9, TX10, TX15, TX20, TX25, TX27, TX30, TX40

Mini TX Keys:

TX6, TX7, TX8, TX9, TX10, TX15

Fold Up Key Set:

4, 5, 6mm Hex, TX25, TX30, 5.5mm Flat, PH2, PZ2

Item ID: **TEDHT42**



7 Pieces mm

T-HANDLE BALL POINT HEX KEY WALL RACK

- Ball point end on the long key end giving access at angles of up to 25°
- Regular hex end on the short arm to apply higher torque to stubborn fastenings
- Supplied with a wall rack for fixing to the wall or a workbench

Ball Point T-Handle Hex Drivers:

100 mm long: 2.5, 3, 4 mm

150 mm long: 5, 6, 7 mm

190 mm long: 8 mm

Item ID: **WRHEX07**

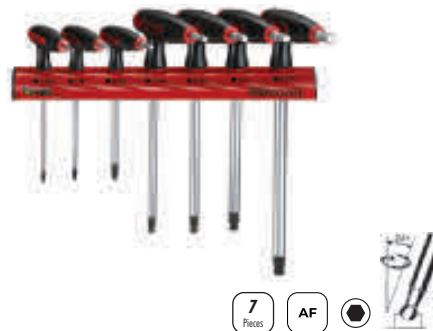

7 Pieces AF

T-HANDLE BALL POINT HEX KEY AF WALL RACK

- Ball point end on the long key end giving access at angles of up to 25°
- Regular hex end on the short arm to apply higher torque to stubborn fastenings
- Supplied with a wall rack for fixing to the wall or a workbench
- Template and fixings included

Ball Point T-Handle Hex Drivers:

100 mm long: 3/32", 1/8", 5/32"

150 mm long: 3/16", 7/32", 1/4"

190 mm long: 5/16"

Item ID: **WRHEX07AF**



TX KEY

- Manufactured in chrome vanadium steel with a black phosphate finish

ITEM ID:	Size TX	For Screws M	Length mm
320008	8	2.5	16x80
320009	9	3	16x83
320010	10	3.0-3.5	17x86
320015	15	3.5-4.0	18x90
320020	20	4.0-5.0	19x95
320025	25	4.5-5.0	20x100
320027	27	4.5-6.0	22x105
320030	30	6.0-7.0	24x114
320040	40	7.0-8.0	26x124
320045	45	8.0-10.0	29x133
320050	50	10	32x152



BALL POINT TX KEY

- Ball point end on the long key end giving access at angles up to 25°
- Ideal for use in confined spaces
- Regular TX end on the short arm giving the ability to apply higher torque
- Manufactured in chrome vanadium steel with a black phosphate finish

ITEM ID:	Size TX	For Screws M	Length mm
320008BL	8	2.5	16x80
320009BL	9	3	16x83
320010BL	10	3.0-3.5	17x86
320015BL	15	3.5-4.0	18x90
320020BL	20	4.0-5.0	19x95
320025BL	25	4.5-5.0	20x100
320027BL	27	4.5-6.0	22x105
320030BL	30	6.0-7.0	24x114
320040BL	40	7.0-8.0	26x124
320045BL	45	8.0-10.0	29x133
320050BL	50	10	32x152



BALL POINT TX KEY CR-MO

- Manufactured in chrome molybdenum steel for added strength
- Ball point end on the long key end giving access at angles up to 25°
- Ideal for use in confined spaces
- Regular hex end on the short arm giving the ability to apply higher torque
- Individually marked for size for easier identification of the right size wrench

ITEM ID:	Size TX	Short Arm Length mm	Long Arm Length mm
390908BL	8	16	80
390909BL	9	16	83
390910BL	10	17	86
390915BL	15	18	90
390920BL	20	19	95
390925BL	25	20	100
390927BL	27	22	105
390930BL	30	24	114
390940BL	40	26	124



T HANDLE BALL POINT TX KEY

- TPX type on the long key end for tamper proof TX fastenings
- Regular TX end on the short arm giving the ability to apply higher torque
- Manufactured in chrome molybdenum for extra strength
- Ergonomically designed bi-material handle for use with higher torque
- Hole in the handle for hanging or for use with a fall protection wire

ITEM ID:	Size TX	Short Arm Length mm	Long Arm Length mm
520009	TX/TPX9	12	100
520010	TX/TPX10	12	100
520015	TX/TPX15	12	100
520020	TX/TPX20	12	100
520025	TX/TPX25	15	150
520027	TX/TPX27	15	150
520030	TX/TPX30	15	150
520040	TX/TPX40	18	190
520045	TX/TPX45	20	200
520050	TX/TPX50	20	200
520055	TX/TPX55	20	200

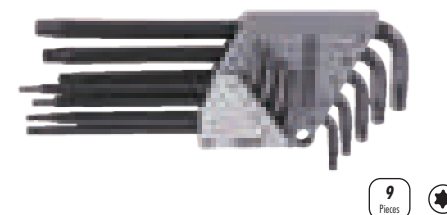

TX KEY SET 9 PIECES

- Chrome vanadium steel with a black finish
- Each key can be easily removed or used by simply twisting in it's individual holder
- Supplied with a folding plastic holder to keep the keys together

TX Keys with folding plastic holder:
 TX8, TX9, TX10, TX15, TX20, TX25, TX27, TX30, TX40

Item ID: **1479TX**



BALL POINT TX KEY SET 9 PIECES

- Ball point end on the long key end giving access at angles up to 25°
- Ideal for use in confined spaces
- Regular end on the short arm giving the ability to apply higher torque
- Chrome vanadium steel with a black finish
- Each key can be easily removed or used by simply twisting in it's individual holder
- Supplied with a folding plastic holder to keep the keys together

TX Keys with folding plastic holder:
 TX8, TX9, TX10, TX15, TX20, TX25, TX27, TX30, TX40

Item ID: **1479TX1**



BALL POINT TX KEY SET CR-MO 9 PIECES

- Chrome molybdenum steel for added strength
- Ball point end on the long key end giving access at angles up to 25°
- Ideal for use in confined spaces
- Regular end on the short arm giving the ability to apply higher torque
- Each key can be easily removed or used by simply twisting in it's individual holder
- Supplied with a folding plastic holder to keep the keys together

TX Keys with folding plastic holder:
 TX8, TX9, TX10, TX15, TX20, TX25, TX27, TX30, TX40

Item ID: **1499TX**



FOLDING TX KEY SET 8 PIECES

- Chrome vanadium steel with a black finish
- Retractable keys held in a fold up aluminium holder

TX Keys with Aluminium Holder:
 TX9, TX10, TX15, TX20, TX25, TX27, TX30, TX40

Item ID: **1476NTX**



FOLDING BALL POINT TX KEY SET 8 PIECES

- Ball point end giving access at angles of up to 25°, ideal for use in confined spaces
- Chrome vanadium steel with a black finish
- Retractable keys held in a fold up aluminium holder

TX Keys with Aluminium Holder:

- TX9, TX10, TX15, TX20, TX25, TX27, TX30, TX40

Item ID: **1476NTX1**



FOLDING TX KEY SET CR-MO 8 PIECES

- Chrome molybdenum steel for added strength
- Retractable keys held in a fold up chromed holder
- Features a fold out ring connector for use with a safety wire for added security when working at heights

TX Keys with Chromed Holder:

- TX9, TX10, TX15, TX20, TX25, TX27, TX30, TX40

Item ID: **1476NTX2**



TX KEY SET 7 PIECES

- Chrome vanadium steel with a matt finish
- Each key can be removed by simply unscrewing from it's individual holder
- Supplied on a ring to keep the keys together

TX Keys with Ring Holder:

- TX10, TX15, TX20, TX25, TX27, TX30, TX40

Item ID: **1487**



TT
SERIES

T-HANDLE TX/TPX KEY SET TTI 7 PIECES

- TPX type on the long key end for tamper proof TX fastenings
- Regular TX end on the short arm giving the ability to apply higher torque
- Removable lid and dove tail joints

T-Handle TX Drivers:

100 mm long:	TX/TPX10, TX/TPX15, TX/TPX20
150 mm long:	TX/TPX25, TX/TPX27, TX/TPX30
190 mm long:	TX/TPX40

Item ID: **TTTX7**



FOAM
SERIES

T-HANDLE BALL POINT TX KEY SET FOAM2

- TPX end on the long key end for use with tamper proof TPX fastenings
- Regular TX end on the short arm giving the ability to apply higher torque
- Tools are held in place using three colour pre-cut EVA foam

T-Handle TX Drivers:

100 mm long:	TX/TPX10, TX/TPX15, TX/TPX20
150 mm long:	TX/TPX25, TX/TPX27, TX/TPX30
190 mm long:	TX/TPX40

Item ID: **TEDTX7**



T-HANDLE TX/TPX KEY WALL RACK

- TPX type on the long key end for tamper proof TX fastenings
- Regular TX end on the short arm to apply higher torque to stubborn fastenings
- Supplied with a wall rack for fixing to the wall or a workbench

T-Handle TX Drivers:

100 mm long:	TX/TPX10, TX/TPX15, TX/TPX20
150 mm long:	TX/TPX25, TX/TPX27, TX/TPX30
190 mm long:	TX/TPX40

Item ID: **WRTX07**

NEW



TPX KEY CR-MO

- TPX type on both end for tamper proof TX fastenings
- Manufactured in chrome molybdenum steel for added strength
- Individually marked for size

ITEM ID:	Size TX	Short Arm Length mm	Long Arm Length mm
390808TPX	TPX8	16	80
390809TPX	TPX9	16	83
390810TPX	TPX10	17	86
390815TPX	TPX15	18	90
390820TPX	TPX20	19	95
390825TPX	TPX25	20	100
390827TPX	TPX27	22	105
390830TPX	TPX30	24	114
390840TPX	TPX40	26	124

NEW



9 PIECE TPX KEY SET 9 PIECES

- Chrome molybdenum steel for added strength
- TPX type on both end for tamper proof TX fastenings
- Each key can be easily removed or used by simply twisting in it's individual holder
- Supplied with a folding plastic holder to keep the keys together

TPX Keys with folding plastic holder:

- TX8, TX9, TX10, TX15, TX20, TX25, TX27, TX30, TX40

Item ID: **1498TPX**



FOLDING KEY SET MIXED 8 PIECES

- Hex, TX and screwdriver key set
- A set of 8 keys
- Chrome vanadium steel with a black finish
- Retractable keys held in a fold up aluminium holder

Ergonomically Designed Aluminium Holder

Individual Keys:

	mm: 1 x 5.5
	PH1
	PZ2
	TX25 TX30
	mm: 4 5 6

Item ID: 1477NX



BICYCLE KEY SET 11 PIECES

- Designed for cyclists to carry easily
- Includes hexagon, TX and screwdriver keys together with a tyre lever and chain repair tool
- Chrome nickel finish
- Supplied in a handy fold up aluminium case

Ergonomically Designed Aluminium Holder,
Tyre lever, Chain tool

Individual Keys:

	mm: 1 x 5.5
	PH2
	TX25 TX30
	mm: 4 5 6

Item ID: 1473



“ I have wasted so much money on cheaper tools. It is so frustrating when they break! With TengTools I know my tools are up to any task I throw at them. ”

TengTools ambassador
Vanessa Ruck

PLIERS

DESIGNED TO MAXIMISE PERFORMANCE

The extensive TengTools range includes pliers for most applications. In addition, the range includes the usual side cutters, combination pliers and slip joint pliers as well as a number of cable pliers, side cutters for cable ties, frapping pliers, nail nippers, electronic pliers, precision shears and tweezers. Two types of handles are available to choose from: slim rubber dipped as well as ergonomic TPR bi-material handles.



Made from chrome molybdenum alloy steel for maximum durability and strength

The cutting capacity is laser marked next to the cutting edge makes it easy to see which pliers you need to choose

TPR GRIP

An ergonomic bi-material handle that is more comfortable in your hand

Extra support when using greater force and a lighter weight

The total length is designed to provide maximum leverage for each pair of pliers, irrespective of whether they are combination, water pump, flat or circlip pliers

VINYL GRIP

A light compact material that is textured to avoid the tool slipping in your hand. The slim design allows for greater access in tight spaces





SIDE CUTTING PLIER

- Chrome molybdenum steel
- 80° cutting edge angle
- Electricians style function
- Vinyl grip for easier use in pockets or tool pouches
- DIN5749

ITEM ID:	Length			High Leverage	Cutting Capacity mm				Weight g
	AF	mm	GRIP		●	◐	◑	◒	
MB441-5	5	135	Vinyl	-	1.5	1.8	2.3	4	111
MB441-6	6	155	Vinyl	-	1.6	2	2.5	4	150
MB442-5	5	140	Vinyl	Y	1.5	1.8	2.3	4	180
MB442-6	6	160	Vinyl	Y	2	2.5	3.8	4	180
MB442-7	7	180	Vinyl	Y	2	2.5	4	4	220
MB442-8	8	200	Vinyl	Y	2.5	3	4	4	240



TPR GRIP

SIDE CUTTING PLIER TPR GRIP

- Chrome molybdenum steel
- 80° cutting edge angle
- Electricians style function
- TPR grip for a more secure and comfortable grip
- DIN5749

ITEM ID:	Length			High Leverage	Cutting Capacity mm				Weight g
	AF	mm	GRIP		●	◐	◑	◒	
MB441-5T	5	135	TPR	-	1.5	1.8	2.3	4	126
MB441-6T	6	155	TPR	-	1.6	2	2.5	4	176
MB442-6T	6	160	TPR	Y	2	2.5	3.8	4	199
MB442-8T	8	200	TPR	Y	2.5	3	4	4	275

● Piano Wire	● Steel Wire
◐ Hard Wire	● Stainless Steel Wire
◑ Medium Hard Wire	● Spring Steel Wire
◒ Soft Wire	● Fe Iron Wire



HEAVY DUTY SIDE CUTTING PLIER WITH SPRING

- Heavy duty with return spring
- Chrome molybdenum steel
- 80° cutting edge angle
- High leverage function for increased cutting capacity
- Vinyl grip for easier use in pockets or tool pouches
- DIN5749

ITEM ID:	Length			High Leverage	Cutting Capacity mm				Weight g
	AF	mm	GRIP		●	◐	◑	◒	
MB442-7S	7	180	Vinyl	Y	2	2.5	4	4	250



TPR GRIP

ANGLED SIDE CUTTING PLIER TPR GRIP

- Chrome molybdenum steel
- 80° cutting edge angle
- Offset nose for access
- High leverage function for increased cutting capacity
- TPR grip for a more secure and comfortable grip
- DIN5749

ITEM ID:	Length			High Leverage	Cutting Capacity mm				Weight g
	AF	mm	GRIP		●	◐	◑	◒	
MB442B-8T	8	200	TPR	Y	2.5	3	4	4	275



CABLE CUTTER

- One hand function with pitch guard for simple safe operation
- High carbon steel for durability and strength
- Vinyl grip for easier use in pockets or tool pouches

ITEM ID:	Length			Weight g
	AF	mm	GRIP	
MB444-6	6	160	Vinyl	181
MB444-8	8	200	Vinyl	322
MB444-10	10	250	Vinyl	381



TPR GRIP

CABLE CUTTER TPR GRIP

- Ideal for cutting copper and aluminium cable up to 38mm²
- One hand function with pitch guard for simple safe operation
- High carbon steel for durability and strength
- TPR grip for a more secure and comfortable grip

ITEM ID:	Length			Capacity mm ²	Weight g
	AF	mm	GRIP		
MB444-8T	8	208	TPR	38	347



TPR GRIP

HEAVY DUTY CABLE CUTTER TPR HANDLE

- Drop forged
- Chrome molybdenum alloy hardened steel cutting blades
- Compound leverage action to increase cutting power
- Simple automatic latch design for one handed operation
- Cuts copper and aluminium electrical cables up to 12mm diameter
- Bi-material handles for a comfortable grip

ITEM ID:	Length			Capacity mm
	AF	mm	GRIP	
496	12	250	TPR	12



HEAVY DUTY CABLE CUTTER

- Ideal for cutting copper and aluminium cable up to 60mm²
- One hand function with pitch guard for simple safe operation
- Chrome molybdenum for increased durability and strength
- Vinyl grip for easier use in pockets or tool pouches

ITEM ID:	Length			Capacity mm ²	Weight g
	AF	mm	GRIP		
MB445-10	10	250	Vinyl	60	412



Do's and Dont's of Pliers

Do's

- Use the right plier for the material
- Make sure the plier grips securely
- Use the right size plier
- Keep it clean & dry

Dont's

- Do not use a plier that does not grip or cut the material
- Do not use on live electrics



MINI BOLT CUTTER

- Chrome molybdenum alloy steel
- 80° cutting edge angle
- Induction hardened cutting edges (HRC58) for increased cutting capacity
- Return spring for easier operation
- Locking function for safe and secure storage
- Vinyl grip for easier use in pockets or tool pouches

ITEM ID:	Length			Cutting Capacity mm			Weight g
	AF	mm	GRIP				
BC408	8	200	Vinyl	3.6	4	5.2	260



TPR GRIP

MINI BOLT CUTTER TPR GRIP

- Chrome molybdenum alloy steel
- 80° cutting edge angle
- Induction hardened cutting edges (HRC58) for increased cutting capacity
- Return spring for easier operation
- Locking function for safe and secure storage
- TPR grip for a more secure and comfortable grip

ITEM ID:	Length			Cutting Capacity mm			Weight g
	AF	mm	GRIP				
BC408T	8	200	TPR	3.6	4	5.2	275

	Piano Wire		Steel Wire
	Hard Wire		Stainless Steel Wire
	Medium Hard Wire		Spring Steel Wire
	Soft Wire		Iron Wire



BOLT CUTTER

- Hardened central cutting edge for durability
- 30° cutting angle for more efficient cutting
- Compound action for easier application of force
- Adjustable centering screw for increased safety when cutting
- Tubular handle with plastic grips for more comfortable use

ITEM ID:	Length			Capacity	Weight g
	AF	mm	GRIP		
BC414	14"	350	7mm HRC15 or 4mm HRC40	1000	
BC418	18"	450	8mm HRC15 or 5mm HRC40	1600	
BC424	24"	600	10mm HRC15 or 6mm HRC40	2500	
BC430	30"	750	13mm HRC15 or 7mm HRC40	3500	
BC436	36"	900	16mm HRC15 or 8mm HRC40	5000	

SPARE PARTS FOR BOLT CUTTERS

- Replacement jaws for bolt cutters
- Includes replacement cutters and fittings
- Economical way to extend the life of the tool

ITEM ID:	For Bolt Cutters:
BC414J	BC414
BC418J	BC418
BC424J	BC424
BC430J	BC430
BC436J	BC436



CABLE/WIRE CUTTER

- Cuts up to 4.0mm stainless steel wire or 1.5mm spring steel cables
- Return spring mechanism for easier operation
- Vinyl grips make the tool more comfortable to use

ITEM ID:	Length			Cutting Capacity mm			Weight g
	AF	mm	GRIP				
498-7N	7	190	Vinyl	4	7	1.5	270



FLUSH CUT PLIER

- Special shaped cutting angle - ideal for cutting cable tie tails flush
- Suitable for cutting other soft materials such as lead, tin, etc.
- Return spring for easier operation
- Vinyl grip for easier use in pockets or tool pouches

ITEM ID:	Length			Weight g
	AF	mm	GRIP	
MB541-5	5	125	Vinyl	100
MB541-6	6	150	Vinyl	143
MB541-7	7	180	Vinyl	227



END NIPPER

- Chrome molybdenum alloy steel for durability and strength
- Vinyl grip for easier use in pockets or tool pouches
- DIN5748

ITEM ID:	Length			Cutting Capacity mm			Weight g
	AF	mm	GRIP				
MB448-6	6	160	Vinyl	1.6	1.8	3.4	200
MB448-8	8	200	Vinyl	1.6	1.8	3.4	250



CARPENTERS PLIER

- 85° cutting edge angle
- Vinyl grip for easier use in pockets or tool pouches

ITEM ID:	Length			Cutting Capacity mm			Weight g
	AF	mm	GRIP				
MB489-7	7	180	Vinyl	1.6	2	262	
MB489-8	8	200	Vinyl	1.8	2.2	283	



TOWER PINCER PLIER

- Chrome molybdenum alloy steel for durability and strength
- Vinyl grip for easier use in pockets or tool pouches

ITEM ID:	Length			Cutting Capacity mm			Weight g
	AF	mm	GRIP				
MB449-9	9	220	Vinyl	1.8	2	3.4	355
MB449-10	10	250	Vinyl	2	2.2	3.8	408
MB449-11	11	280	Vinyl	2.5	3	4	492



COMBINATION PLIER

- Features a pipe grip with serrated jaw for a more secure grip
- Chrome molybdenum alloy steel for durability and strength
- 80° cutting edge angle
- Vinyl grip for easier use in pockets or tool pouches
- DIN5746

ITEM ID:	Length			High Leverage	Cutting Capacity mm			Weight g
	AF	mm	GRIP		●	◐	◑	
MB451-7	7	180	Vinyl	N	1.8	2	3.8	195
MB451-8	8	200	Vinyl	N	2	2.2	4	253
MB452-6	6	160	Vinyl	Y	1.6	1.8	3.4	200
MB452-7	7	180	Vinyl	Y	1.8	2	3.8	210
MB452-8	8	200	Vinyl	Y	2	2.2	4	240
MB452-9	9	225	Vinyl	Y	2	2.2	4	380



TPR GRIP

HEAVY DUTY COMBINATION PLIER TPR GRIP

- High leverage function for increased gripping and cutting power
- Features a pipe grip with serrated jaw for a more secure grip
- Chrome molybdenum alloy steel for durability and strength
- 80° cutting edge angle
- TPR grip for a more secure and comfortable grip
- DIN5746

ITEM ID:	Length			High Leverage	Cutting Capacity mm			Weight g
	AF	mm	GRIP		●	◐	◑	
MB452-6T	6	160	TPR	Y	1.6	1.8	3.4	210
MB452-7T	7	180	TPR	Y	1.8	2	3.8	220
MB452-8T	8	200	TPR	Y	2	2.2	4	266

●	Piano Wire	●	Steel Wire
◐	Hard Wire	●	Stainless Steel Wire
◑	Medium Hard Wire	●	Spring Steel Wire
◒	Soft Wire	Fe	Iron Wire



LONG NOSE PLIER

- Long straight jaws for easier access
- Jaws with a serrated grip for increased gripping power
- Chrome molybdenum alloy steel for durability and strength
- 80° cutting edge angle
- Vinyl grip for easier use in pockets or tool pouches
- DIN5745

ITEM ID:	Length			Cutting Capacity mm			Weight g
	AF	mm	GRIP	●	◐	◑	
MB461-5	5	140	Vinyl	1	1.5	2.5	130
MB461-6	6	160	Vinyl	1	1.5	2.5	130
MB461-8	8	200	Vinyl	1.5	1.8	2.8	180



TPR GRIP

LONG NOSE PLIER TPR GRIP

- Long straight jaws for easier access
- Jaws with a serrated grip for increased gripping power
- Chrome molybdenum alloy steel for durability and strength
- 80° cutting edge angle
- TPR grip for a more secure and comfortable grip
- DIN5745

ITEM ID:	Length			Cutting Capacity mm			Weight g
	AF	mm	GRIP	●	◐	◑	
MB461-6T	6	160	TPR	1	1.5	2.5	139
MB461-8T	8	200	TPR	1.5	1.8	2.8	185



BENT LONG NOSE PLIER

- Long 45° offset jaws for easier access
- Jaws with a serrated grip for increased gripping power
- Chrome molybdenum alloy steel for durability and strength
- 80° cutting edge angle
- Vinyl grip for easier use in pockets or tool pouches
- DIN5745

ITEM ID:	Length			Cutting Capacity mm			Weight g
	AF	mm	GRIP	●	◐	◑	
MB463-5	5	140	Vinyl	1	1.5	2.5	150
MB463-6	6	160	Vinyl	1	1.5	2.5	160
MB463-8	8	200	Vinyl	1.5	1.8	2.8	167



TPR GRIP

BENT LONG NOSE PLIER TPR GRIP

- Long 45° offset jaws for easier access
- Jaws with a serrated grip for increased gripping power
- Chrome molybdenum alloy steel for durability and strength
- 80° cutting edge angle
- TPR grip for a more secure and comfortable grip
- DIN5745

ITEM ID:	Length			Cutting Capacity mm			Weight g
	AF	mm	GRIP	●	◐	◑	
MB463-8T	8	200	TPR	1.5	1.8	2.8	186



FLAT NOSE PLIER

- Long straight jaws for easier access
- Chrome molybdenum alloy steel for durability and strength
- Vinyl grip for easier use in pockets or tool pouches
- DIN5745

ITEM ID:	Length			Weight g
	AF	mm	GRIP	
MB464-6	6	165	Vinyl	120



TPR GRIP

FLAT NOSE PLIER TPR GRIP

- Long straight jaws for easier access
- Chrome molybdenum alloy steel for durability and strength
- TPR grip for a more secure and comfortable grip
- DIN5745

ITEM ID:	Length			Weight g
	AF	mm	GRIP	
MB464-6T	6	165	TPR	120



ROUND NOSE PLIER

- Polished finish with a smooth tip
- Return spring for easier use
- Chrome molybdenum alloy steel for durability and strength
- Vinyl grip for easier use in pockets or tool pouches

ITEM ID:	Length			Weight g
	AF	mm	GRIP	
MB465-6	6	150	Vinyl	170



LONG REACH PLIER

- The long reach enables the plier to reach in to recessed areas
- Body hardness HRC43-48 for long lasting use
- Vinyl grip for easier use in pockets or tool pouches

ITEM ID:	Length				Type	Weight g
	AF	mm	GRIP			
AT096	11	275	Vinyl		Straight	300
AT097	11	275	Vinyl	Angled 45		300



GROOVE JOINT WATER PUMP PLIER

- Serrated jaws for a more secure grip
- Non slip groove joints for use with higher force
- Chrome vanadium with a polished head
- Vinyl grip for easier use in pockets or tool pouches

ITEM ID:	Length				Capacity mm	Weight g
	AF	mm	GRIP			
MB410	10	250	Vinyl		45	425
MB412	12	300	Vinyl		60	600
MB416	16	400	Vinyl		90	1330



WATER PUMP PLIER

- Pipe grip with serrated jaws for increased grip
- Chrome vanadium steel construction
- Vinyl grip for easier use in pockets or tool pouches

ITEM ID:	Length			Capacity mm	Jaw Hardness	Weight g
	AF	mm	GRIP			
MB481-7	7	180	Vinyl	3-25	HRC 55	159
MB481-10	10	250	Vinyl	3-38	HRC 55	175



TPR GRIP

WATER PUMP PLIER TPR GRIP

- Pipe grip with serrated jaws for increased grip
- Chrome vanadium steel construction
- TPR grip for a more secure and comfortable grip

ITEM ID:	Length			Capacity mm	Jaw Hardness	Weight g
	AF	mm	GRIP			
MB481-7T	7	180	TPR	3-25	HRC 55	344
MB481-10T	10	250	TPR	3-38	HRC 55	371



QUICK SET WATER PUMP PLIER HRC60

- Simply position the upper jaw against the work piece and press the button to close the jaw - quick, simple and time saving
- Pipe grip with serrated jaws for increased grip
- Shaped to protect the operators fingers

ITEM ID:	Length			Jaw Hardness	Capacity mm	Weight g
	AF	mm	GRIP			
MB482-7Q	7	190	Vinyl	HRC 60	3-25	182
MB482-10Q	10	250	Vinyl	HRC 60	3-38	335



QUICK SET WATER PUMP PLIER

- Simply position the upper jaw against the work piece and press the button to close the jaw - quick, simple and time saving
- Pipe grip with serrated jaws for increased grip
- Shaped to protect the operators fingers

ITEM ID:	Length				Jaw Hardness	Capacity mm	Weight g
	AF	mm	GRIP	Jaws			
MB481-10Q	10	250	Vinyl	Cr-V	HRC 55	3-38	380



TPR GRIP

QUICK SET WATER PUMP PLIER TPR GRIP

- Simply position the upper jaw against the work piece and press the button to close the jaw - quick, simple and time saving
- Pipe grip with serrated jaws for increased grip
- Shaped to protect the operators fingers

ITEM ID:	Length				Jaw Hardness	Capacity mm	Weight g
	AF	mm	GRIP	Jaws			
MB481-10TQ	10	250	TPR	Cr-V	HRC 55	3-38	405



TPR GRIP

QUICK SET WATER PUMP PLIER TPR GRIP HRC60

- Simply position the upper jaw against the work piece and press the button to close the jaw - quick, simple and time saving
- Pipe grip with serrated jaws for increased grip
- Shaped to protect the operators fingers

ITEM ID:	Length				Jaw Hardness	Capacity mm	Weight g
	AF	mm	GRIP	Jaws			
MB482-10TQ	10	250	TPR		HRC 60	3-38	359



TT SERIES



4 Pieces

PLIER SET VINYL GRIP TTI 4 PIECES

- Vinyl grip for easier use in pockets or tool pouches
- All the most commonly used pliers in one set

Pliers:	
SIDE CUTTER	6" / 155 mm
COMBINATION	7" / 180 mm
LONG NOSE	8" / 200 mm
WATER PUMP	10" / 250 mm

Item ID: TT440



TT SERIES



28 Pieces

TPR GRIP

PLIER SET TPR GRIP TTI 4 PIECES

- TPR grip for a more secure and comfortable grip
- All the most commonly used pliers in one set

Pliers:	
SIDE CUTTER	6" / 155 mm
COMBINATION	7" / 180 mm
LONG NOSE	8" / 200 mm
WATER PUMP	10" / 250 mm

Item ID: TT440-T

	Piano Wire		Steel Wire
	Hard Wire		Stainless Steel Wire
	Medium Hard Wire		Spring Steel Wire
	Soft Wire		Iron Wire



TT SERIES
2 Pieces

PLIER SET VINYL GRIP TT2 8 PIECES

- Vinyl grip for easier use in pockets or tool pouches
- All the most commonly used pliers in one set
- Supplied in the unique TengTools double width TC tray

Pliers:			
HEAVY DUTY SIDE CUTTER	6" / 160 mm	LONG NOSE	6" / 160 mm
	8" / 200 mm		8" / 200 mm
HIGH LEVERAGE COMBINATION	6" / 160 mm	WATER PUMP	7" / 180 mm
	8" / 200 mm		10" / 250 mm

Item ID: **TTD441**



TT SERIES
2 Pieces

PLIER SET TPR GRIP TT2 8 PIECES

- TPR grip for a more secure and comfortable grip
- All the most commonly used pliers in one set
- Supplied in the unique TengTools double width TC tray

Pliers:			
HEAVY DUTY SIDE CUTTER	6" / 160 mm	LONG NOSE	6" / 160 mm
	8" / 200 mm		8" / 200 mm
HIGH LEVERAGE COMBINATION	6" / 160 mm	WATER PUMP	7" / 180 mm
	8" / 200 mm		10" / 250 mm

Item ID: **TTD441-T**



TT SERIES
x4

2 Pieces

PLIER & WRENCH SET TTX4 2 PIECES

- 2 tools for gripping even the most stubborn nuts and bolts
- Supplied in the unique TengTools drawer width TTX tray

Pliers:	
QUICK ACTION WATER PUMP	10" / 250 mm
Wrenches	
ALIGATOR ADJUSTABLE	8" / 200 mm

Item ID: **TTXMB02**



FOAM SERIES
2

5 Pieces

TPR GRIP

PLIER SET TPR GRIP FOAM2 5 PIECES

- TPR grip for a more secure and comfortable grip
- All the most commonly used pliers in one set
- Supplied in the unique TengTools double width TC tray
- Tools are held in place using three colour pre-cut EVA foam clearly showing where each tool belongs

Pliers:	
SIDE CUTTER	5" / 135 mm
HEAVY DUTY SIDE CUTTERS	8" / 200 mm
HIGH LEVERAGE COMBINATION PLIERS	8" / 200 mm
LONG NOSE PLIERS	8" / 200 mm
WATER PUMP PLIERS	10" / 250 mm

Item ID: **TED441-T**



4 Pieces

TPR GRIP

PLIER SET WALL RACK 4 PIECES

- TPR grip for a more secure and comfortable grip
- All the most commonly used pliers in one set
- Supplied with a wall rack for fixing to the wall or a work-bench

Pliers:	
SIDE CUTTER	6" / 155 mm
HIGH LEVERAGE COMBINATION PLIERS	7" / 180 mm
LONG NOSE PLIERS	8" / 200 mm
WATER PUMP PLIERS	10" / 250 mm

Item ID: **WRMB04**

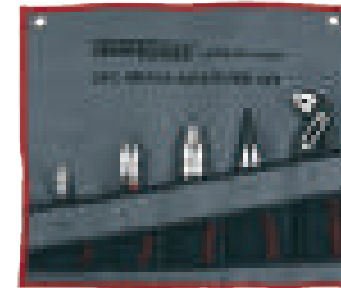

5 Pieces

PLIER SET TOOL ROLL 5 PIECES

- All the most commonly used pliers in one set
- All the pliers have a vinyl grip for easier use in pockets or tool pouches
- Supplied in a heavy duty tool roll storage wallet

Pliers:	
SIDE CUTTER	4 1/2" / 110 mm
	6" / 155 mm
COMBINATION PLIERS	7" / 180 mm
LONG NOSE PLIERS	8" / 200 mm
WATER PUMP PLIERS	10" / 250 mm

Item ID: **445W**

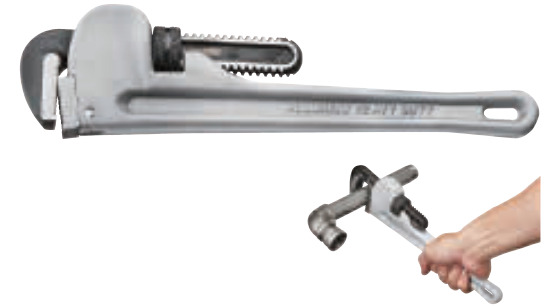

ALUMINIUM PIPE WRENCH

- Lightweight aluminium construction
- Sturdy design with steel jaws and adjustment thread
- One hand operation

ITEM ID:	Length		Capacity		Weight g
	mm	AF	mm	AF	
PWC12	300	12"	43	1-11/16"	670
PWC14	350	14"	50	1-31/32"	860
PWC18	450	18"	60	2-23/64"	1390
PWC24	600	24"	76	3"	2220
PWC36	900	36"	102	4-1/64"	4030



TPR GRIP

WIRE STRIPPING PLIER TPR GRIP

- Medium carbon alloy steel construction
- With adjuster screw to suit wire diameters from 0.2 to 4.5mm²
- Return spring for easier operation
- TPR grip for a more secure and comfortable grip

ITEM ID:	Length			Capacity mm	Weight g
	mm	AF	GRIP		
MB499-7T	155	6	TPR	0.2 - 4.5	175



MINI SIDE CUTTING PLIER

- 68° cutting angle angle
- Cuts up to 0.8mm wire
- High carbon steel construction
- Return spring for easier operation
- Vinyl grip for easier use in pockets or tool pouches

ITEM ID:	Length			Capacity mm	Weight g
	mm	AF	GRIP		
MBM441	125	5	Vinyl	0.8	67



MINI LONG NOSE PLIER

- Long straight jaws for easier access
- 68° cutting angle angle
- Cuts up to 0.8mm wire
- High carbon steel construction
- Return spring for easier operation
- Vinyl grip for easier use in pockets or tool pouches

ITEM ID:	Length			Capacity mm	Weight g
	mm	AF	GRIP		
MBM461	125	5	Vinyl	0.8	81



MINI ROUND NOSE PLIER

- Long straight jaws for easier access
- High carbon steel construction
- Return spring for easier operation
- Vinyl grip for easier use in pockets or tool pouches

ITEM ID:	Length			Weight g
	mm	AF	GRIP	
MBM467	125	5	Vinyl	71



MINI BENT LONG NOSE PLIER

- Long offset straight jaws for easier access
- High carbon steel construction
- Return spring for easier operation
- Vinyl grip for easier use in pockets or tool pouches

ITEM ID:	Length			Weight g
	mm	AF	GRIP	
MBM469	150	6	Vinyl	78



MINI END CUTTING PLIER

- 68° cutting angle angle
- Cuts up to 0.8mm wire
- High carbon steel construction
- Return spring for easier operation
- Vinyl grip for easier use in pockets or tool pouches

ITEM ID:	Length			Capacity mm	Weight g
	mm	AF	GRIP		
MBM449	110	4 ½	Vinyl	0.8	70



MINI FLAT NOSE PLIER

- Long straight jaws for easier access
- High carbon steel construction
- Return spring for easier operation
- Vinyl grip for easier use in pockets or tool pouches

ITEM ID:	Length			Weight g
	mm	AF	GRIP	
MBM464	125	5	Vinyl	85



MINI NEEDLE NOSE PLIER

- Long straight jaws for easier access
- High carbon steel construction
- Return spring for easier operation
- Vinyl grip for easier use in pockets or tool pouches

ITEM ID:	Length			Weight g
	mm	AF	GRIP	
MBM468	150	6	Vinyl	75



TT
SERIES



MINI PLIERS & SCREWDRIVER SET TTI 16 PIECES

- Mini screwdrivers feature a rotating end piece for easier use when "transporting" the fastening
- Mini pliers feature high carbon steel construction and vinyl grip handles

Mini Screwdrivers:

	mm:	2.0 x 40	2.4 x 40	3.0 x 40
	mm:	PH00 x 40	PH0 x 40	PH1 x 40
	mm:	TX6 x 40	TX7 x 40	TX8 x 40
		TX9 x 40	TX10 x 40	TX15 x 40

Mini Pliers:

4 ½"	SIDE CUTTER
4 ½"	END CUTTER
5"	LONG NOSE PLIER
5"	FLAT NOSE PLIER

Item ID: **TTMI16**



SELF LOCKING PLIER

- Serrated jaw for improved grip
- Made from special grade stainless steel suitable for use in special environments
- Three step lock function and precision joint construction for precise gripping
- Matt finish
- Hot drop forged construction for greater strength and durability

ITEM ID:	Length		Jaw Type	Weight
	mm	AF		
SLP1160	160	6	Straight Serrated	43
SLP2180	180	7	Straight Serrated	45
SLP3160	160	6	Curved Serrated	50
SLP3180	180	7	Curved Serrated	58



STRAIGHT TWEEZERS

- Serrated jaw for improved grip
- Made from special grade stainless steel suitable for use in special environments
- Matt finish
- Hot drop forged construction for greater strength and durability

ITEM ID:	Length	Tip Type		Weight
		mm	Tip Type	
TW1160	160	Straight	Serrated	37
TW1180	180	Straight	Serrated	37



BENT TWEEZERS SERRATED JAW

- Serrated jaw for improved grip
- Made from special grade stainless steel suitable for use in special environments
- Matt finish
- Hot drop forged construction for greater strength and durability

ITEM ID:	Length	Tip Type		Weight
		mm	Tip Type	
TW2125	125	Bent	Serrated	29



BENT TWEEZERS SMOOTH JAW

- Smooth jaw for a more delicate grip
- Made from special grade stainless steel suitable for use in special environments
- Matt finish
- Hot drop forged construction for greater strength and durability

ITEM ID:	Length	Tip Type		Weight
		mm	Tip Type	
TW2160	160	Bent	Smooth	42



Z SHAPE NEEDLE TIPS TWEEZERS

- Needle tips for a more precise grip
- Made from special grade stainless steel suitable for use in special environments
- Matt finish
- Hot drop forged construction for greater strength and durability

ITEM ID:	Length	Tip Type		Weight
		mm	Tip Type	
TW2180	170	Z Shape	Needle Tip	35



CIRCLIP PLIER INTERCHANGEABLE TIPS

- 10-50mm capacity covering a wide range of applications
- Interchangeable heads for bent or straight with 1.2 and 1.5mm tips
- Inner or Outer fitting giving 8 different possible combinations
- Magnetic tips to help hold the circlip when inserting or removing, especially useful with smaller circlips
- A return spring gives smooth and easy operation
- Vinyl grips make the tool more comfortable to use

Handle:		
REVERSIBLE, SPRING LOADED HANDLE WITH LOCKING PIN		
Magnetic Tips:		
STRAIGHT	INNER / OUTER	1.2 mm TIP
	INNER / OUTER	1.5 mm TIP
45° TIP	INNER / OUTER	
90° TIP	INNER / OUTER	

Item ID: 480

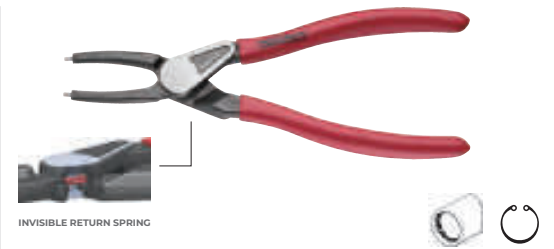

CIRCLIP PLIER INNER STRAIGHT PRO

- Invisible return spring for easier operation
- For use with inner type circlips or snap rings
- Bearing steel tips for heavy duty applications
- Non slip tip angle enabling the ring to stock securely to the tip when compressing or expanding the circlip
- Chrome vanadium construction
- Vinyl grip for easier use in pockets or tool pouches
- DIN 5256

ITEM ID:	Length		Capacity	Type	Tip	Weight
	mm	AF				
MBE470-5	140	5	12-25	Straight	Inner	1.3 80
MBE470-7	185	7	19-60	Straight	Inner	1.8 150
MBE470-9	235	9	40-100	Straight	Inner	2.3 295

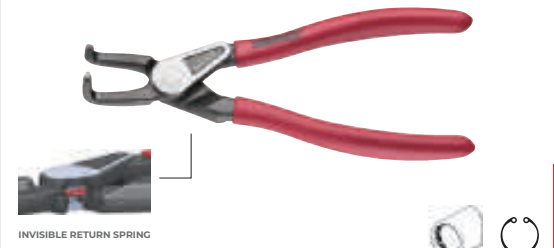

CIRCLIP PLIER INNER BENT PRO

- Invisible return spring for easier operation
- For use with inner type circlips or snap rings
- Bearing steel tips for heavy duty applications
- Non slip tip angle enabling the ring to stock securely to the tip when compressing or expanding the circlip
- Chrome vanadium construction
- Vinyl grip for easier use in pockets or tool pouches
- DIN 5256

ITEM ID:	Length		Capacity	Type	Tip	Weight
	mm	AF				
MBE471-5	125	5	12-25	Bent	Inner	1.3 80
MBE471-7	170	7	19-60	Bent	Inner	1.8 150
MBE471-9	215	9	40-100	Bent	Inner	2.3 295

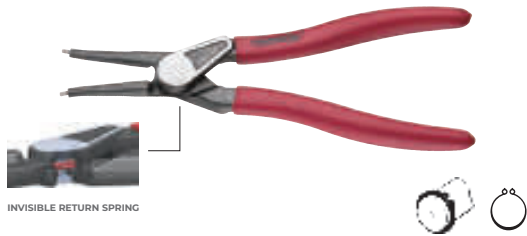

CIRCLIP PLIER OUTER STRAIGHT PRO

- Invisible return spring for easier operation
- For use with outer type circlips or snap rings
- Bearing steel tips for heavy duty applications
- Non slip tip angle enabling the ring to stock securely to the tip when compressing or expanding the circlip
- Chrome vanadium construction
- Vinyl grip for easier use in pockets or tool pouches
- DIN5254

ITEM ID:	Length		Capacity	Type	Tip	Weight
	mm	AF				
MBE472-5	140	5	12-25	Straight	Outer	1.3 90
MBE472-7	185	7	19-60	Straight	Outer	1.8 170
MBE472-9	235	9	40-100	Straight	Outer	2.3 310



CIRCLIP PLIER INNER STRAGHT

- For use with inner type circlips or snap rings
- Chrome vanadium construction
- Return spring for easier use
- Vinyl grip for easier use in pockets or tool pouches
- DIN 5256

ITEM ID:	Length		Capacity	Type	Tip	Weight
	mm	AF				
MB470-5	130	5	12-25	Straight	Inner	1.3 100
MB470-7	175	7	19-60	Straight	Inner	1.8 134
MB470-9	225	9	40-100	Straight	Inner	2.3 160



CIRCLIP PLIER OUTER STRAIGHT

- For use with outer type circlips or snap rings
- Chrome vanadium construction
- Return spring for easier use
- Vinyl grip for easier use in pockets or tool pouches
- DIN5254

ITEM ID:	Length		Capacity	Type	Tip	Weight
	mm	AF				
MB472-5	130	5	12-25	Straight	Outer	1.3 100
MB472-7	175	7	19-60	Straight	Outer	1.8 134
MB472-9	225	9	40-100	Straight	Outer	2.3 160

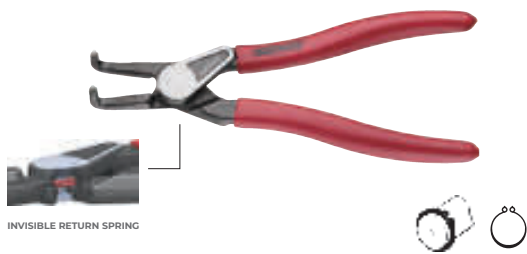

CIRCLIP PLIER OUTER BENT PRO

- Invisible return spring for easier operation
- For use with outer type circlips or snap rings
- Bearing steel tips for heavy duty applications
- Non slip tip angle enabling the ring to stock securely to the tip when compressing or expanding the circlip
- Chrome vanadium construction
- Vinyl grip for easier use in pockets or tool pouches
- DIN5254

ITEM ID:	Length		Capacity	Type	Tip	Weight
	mm	AF				
MBE473-5	125	5	12-25	Bent	Outer	1.3 90
MBE473-7	170	7	19-60	Bent	Outer	1.8 170
MBE473-9	215	9	40-100	Bent	Outer	2.3 310



CIRCLIP PLIER INNER BENT

- For use with inner type circlips or snap rings
- Chrome vanadium construction
- Return spring for easier use
- Vinyl grip for easier use in pockets or tool pouches
- DIN 5256

ITEM ID:	Length		Capacity	Type	Tip	Weight
	mm	AF				
MB471-5	130	5	12-25	Bent	Inner	1.3 100
MB471-7	175	7	19-60	Bent	Inner	1.8 134
MB471-9	225	9	40-100	Bent	Inner	2.3 160



CIRCLIP PLIER OUTER BENT

- For use with outer type circlips or snap rings
- Chrome vanadium construction
- Return spring for easier use
- Vinyl grip for easier use in pockets or tool pouches
- DIN5254

ITEM ID:	Length		Capacity	Type	Tip	Weight
	mm	AF				
MB473-5	130	5	12-25	Bent	Outer	1.3 100
MB473-7	175	7	19-60	Bent	Outer	1.8 134
MB473-9	225	9	40-100	Bent	Outer	2.3 160

NEW



TT SERIES

4 Pieces

CIRCLIP PLIER SET PRO 12-25 MM TTI 4 PIECES

- Invisible return spring for easier operation.
- For use with inner and outer type circlips or snap rings.
- 1.3mm bearing steel tip for heavy duty applications.
- Non slip tip angle enabling the ring to stock securely to the tip when compressing or expanding the circlip.
- 12 to 25mm capacity.
- Chrome vanadium construction.
- Vinyl grip for easier use in pockets or tool pouches
- DIN5254 and DIN5256

5" / 130 mm Circlip Pliers:		Capacity
STRAIGHT	INNER	12 - 25 mm
	OUTER	12 - 25 mm
BENT	INNER	12 - 25 mm
	OUTER	12 - 25 mm



Item ID: TT474-5E

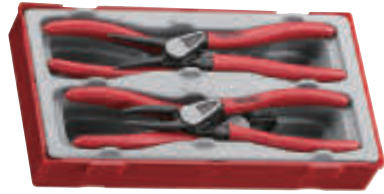

TT SERIES
1

4 Pieces

CIRCLIP PLIER SET PRO 19-60 MM TTI 4 PIECES

- Invisible return spring for easier operation
- For use with inner and outer type circlips or snap rings
- 1.8mm bearing steel tips for heavy duty applications
- Non slip tip angle enabling the ring to stock securely to the tip when compressing or expanding the circlip
- 19 to 60mm capacity
- Chrome vanadium construction
- Return spring for easier use
- Vinyl grip for easier use in pockets or tool pouches
- DIN5254 and DIN5256

7" Circlip Pliers:		Capacity
STRAIGHT	INNER	19 - 60 mm
	OUTER	19 - 60 mm
BENT	INNER	19 - 60 mm
	OUTER	19 - 60 mm



INVISIBLE RETURN SPRING

Item ID: **TT474-7E**

NEW



TT SERIES
x4

4 Pieces

CIRCLIP PLIER SET PRO 40-100 MM TTX4

- Invisible return spring for easier operation.
- For use with inner and outer type circlips or snap rings.
- 2,3mm bearing steel tip for heavy duty applications.
- Non slip tip angle enabling the ring to stock securely to the tip when compressing or expanding the circlip.
- 40 to 100mm capacity.
- Chrome vanadium construction.
- Vinyl grip for easier use in pockets or tool pouches
- DIN5254 and DIN5256

9" / 225 mm Circlip Pliers:		Capacity
STRAIGHT	INNER	40 - 100 mm
	OUTER	40 - 100 mm
BENT	INNER	40 - 100 mm
	OUTER	40 - 100 mm



INVISIBLE RETURN SPRING

Item ID: **TTX474-9E**



TT SERIES
1

4 Pieces

CIRCLIP PLIER SET 10-25 MM TTI 4 PIECES

- For use with inner and outer type circlips or snap rings
- 1.3mm tip and 10 to 25mm capacity
- Chrome vanadium construction
- Return spring for easier use
- Vinyl grip for easier use in pockets or tool pouches
- DIN5254/DIN5256

5" / 130 mm Circlip Pliers:		Capacity
STRAIGHT	INNER	12 - 25 mm
	OUTER	12 - 25 mm
BENT	INNER	12 - 25 mm
	OUTER	12 - 25 mm

Item ID: **TT474-5**



TT SERIES
1

4 Pieces

CIRCLIP PLIER SET 19-60 MM TTI 4 PIECES

- For use with inner and outer type circlips or snap rings
- 1.8mm tip and 19 to 60mm capacity
- Chrome vanadium construction
- Return spring for easier use
- Vinyl grip for easier use in pockets or tool pouches
- DIN5254 and DIN5256

7" / 175 mm Circlip Pliers:		Capacity
STRAIGHT	INNER	19 - 60 mm
	OUTER	19 - 60 mm
BENT	INNER	19 - 60 mm
	OUTER	19 - 60 mm

Item ID: **TT474-7**



TT SERIES
x4

4 Pieces

CIRCLIP PLIER SET 40-100 MM TTX4 4 PIECES

- For use with inner and outer type circlips or snap rings
- 2.3mm tip and 40 to 100mm capacity
- Chrome vanadium construction
- Return spring for easier use
- Vinyl grip for easier use in pockets or tool pouches
- DIN5254 and DIN5256

9" / 225 mm Circlip Pliers:		Capacity
STRAIGHT	INNER	40 - 100 mm
	OUTER	40 - 100 mm
BENT	INNER	40 - 100 mm
	OUTER	40 - 100 mm

Item ID: **TTX474-9**



CURVED JAW POWER GRIP PLIER

- Self locking with release lever
- With locking nut on adjustment knob for pre-setting, ideal for repeated use
- Wire cutter and crimper function
- Chrome molybdenum

ITEM ID:	AF	Length		Capacity	Weight
		mm	mm		
40I-4	4	100	25	75	
40I-5	5	125	28	180	
40I-7	7	180	38	345	
40I-10	10	250	47	514	
40I-12	12	300	50	680	



FLAT JAW POWER GRIP PLIER

- Self locking with release lever
- With locking nut on adjustment knob for pre-setting, ideal for repeated use
- Chrome molybdenum

ITEM ID:	AF	Length		Capacity	Weight
		mm	mm		
40I-10F	10	250	45	527	
40I-12F	12	300	52	693	



LONG NOSE POWER GRIP PLIER

- Self locking with release lever
- With locking nut on adjustment knob for pre-setting, ideal for repeated use
- Wire cutter and crimper function
- Chrome molybdenum

ITEM ID:	Length		Capacity mm	Weight g
	AF	mm		
404-4	4	100	35	180
404-6	6	155	35	197
404-9	9	230	70	380



OIL FILTER REMOVAL PLIER

- 53-118mm capacity to suit most oil filters
- Two stage grip areas on the jaws for added versatility
- Ideal for removing and installing objects of many shapes when a tight grip is required
- Chrome vanadium with drop forged jaws, heat treated and nickel plated

Item ID: 409



LONG NOSE GRIP PLIER NON PINCH

- Narrow jaw for use in confined spaces
- Self locking with non pinch, one handed operation release lever
- With locking nut on adjustment knob for pre-setting, ideal for repeated use
- Wire cutter and crimper function
- Chrome molybdenum

ITEM ID:	Length		Capacity mm	Weight g
	AF	mm		
404-6S	6	160	35	185



TT
SERIES
1

5
Pieces

POWER GRIP PLIER SET TTI 5 PIECES

- All the most commonly used power grip pliers in one set
- Self locking with release lever
- With locking nut on adjustment knob for pre-setting, ideal for repeated use
- Wire cutter and crimper function
- Chrome molybdenum

Power Grip Pliers:	
	4" / 100 mm
STANDARD ROUND JAW	7" / 180 mm
	10" / 250 mm
	4" / 100 mm
LONG NOSE	6" / 155 mm

Item ID: TTVG05



TT
SERIES
x2

3
Pieces

POWER GRIP PLIER SET TTX2 3 PIECES

- The most commonly used power grip pliers in one set
- Self locking with release lever
- With locking nut on adjustment knob for pre-setting, ideal for repeated use
- Wire cutter and crimper function
- Chrome molybdenum

Power Grip Pliers:	
STANDARD ROUND JAW	4" / 100 mm
	4" / 100 mm
LONG NOSE	6" / 155 mm

Item ID: TTVZG03



POWER GRIP PLIER SET

- The two most commonly used types in one handy set
- Self locking with release lever
- With locking nut on adjustment knob for pre-setting, ideal for repeated use
- Wire cutter and crimper function
- Chrome molybdenum

Power Grip Pliers:	
STANDARD ROUND JAW	10" / 250 mm
LONG NOSE	6" / 155 mm

Item ID: 402



C CLAMP POWER GRIP PLIER

- Self locking with release lever
- With locking nut on adjustment knob for pre-setting, ideal for repeated use
- Chrome vanadium with nickel plating

ITEM ID:	L	L	Capacity mm	Throat Depth mm	Throat Height mm	Weight g
	mm	AF				
406-6	172	6"	0-50	40	60	235
406	280	11"	0-80	70	100	772



C CLAMP POWER GRIP PLIER NON PINCH

- Non pinch one hand operation for easier use
- Self locking with release lever
- With locking nut on adjustment knob for pre-setting, ideal for repeated use
- Chrome vanadium with nickel plating

ITEM ID:	L	L	Capacity mm	Throat Depth mm	Throat Height mm	Weight g
	mm	AF				
406-6S	172	6"	0-50	40	60	235
406S	285	11"	0-80	70	100	760



SWIVEL C CLAMP POWER GRIP PLIER

- Swivel pads for a self levelling grip when clamping
- Self locking with release lever
- With locking nut on adjustment knob for pre-setting, ideal for repeated use
- Chrome vanadium

ITEM ID:	L mm	L AF	Capacity mm	Throat Depth mm	Throat Height mm	Weight g
406-6P	172	6"	0-50	40	60	235
406P	280	11"	0-80	70	100	772



SWIVEL C CLAMP GRIP PLIER NON PINCH

- Swivel pads for a self levelling grip when clamping
- Non pinch one hand operation for easier use
- Self locking with release lever
- With locking nut on adjustment knob for pre-setting, ideal for repeated use
- Chrome vanadium with nickel plating

ITEM ID:	L mm	L AF	Capacity mm	Throat Depth mm	Throat Height mm	Weight g
406-6SP	172	6"	0-50	40	60	235
406SP	285	11"	0-80	70	100	760



C CLAMP LONG POWER GRIP PLIER

- Self locking with release lever
- With locking nut on adjustment knob for pre-setting, ideal for repeated use
- Chrome vanadium

ITEM ID:	L mm	L AF	Capacity mm	Throat Depth mm	Throat Height mm	Weight g
418S	450	18"	0-150	250	130	1192



SWIVEL C CLAMP LONG POWER GRIP PLIER

- Swivel pad for a self levelling grip when clamping
- Self locking with release lever
- With locking nut on adjustment knob for pre-setting, ideal for repeated use
- Chrome vanadium

ITEM ID:	L mm	L AF	Capacity mm	Throat Depth mm	Throat Height mm	Weight g
418SP	450	18"	0-150	250	130	1192



WELDING POWER GRIP PLIER

- Self locking with release lever
- With locking nut on adjustment knob for pre-setting, ideal for repeated use
- Chrome vanadium

ITEM ID:	L mm	L AF	Capacity mm	Weight g
407	230	9"	0-65	580



WELDING POWER GRIP PLIER NON PINCH

- Non pinch one hand operation for easier use
- Self locking with release lever
- With locking nut on adjustment knob for pre-setting, ideal for repeated use
- Chrome vanadium with nickel plating

ITEM ID:	L mm	L AF	Cap Width mm	Jaw Depth mm	Weight g
407AS	270	11"	90	85	855



SHEET METAL POWER GRIP PLIER

- Self locking with release lever
- With locking nut on adjustment knob for pre-setting, ideal for repeated use
- Chrome vanadium

ITEM ID:	L mm	L AF	Capacity mm	Weight g
408	230	8"	0-65	580



SWIVEL CLAMPING POWER GRIP PLIER

- Swivel pads for a self levelling grip when clamping
- Non pinch one hand operation for easier use
- Self locking with release lever
- With locking nut on adjustment knob for pre-setting, ideal for repeated use
- Chrome vanadium with nickel plating

ITEM ID:	L mm	L AF	Capacity mm	Weight g
409P	300	12"	0-65	580



SWIVEL CLAMPING GRIP PLIER NON PINCH

- Swivel pads for a self levelling grip when clamping
- Non pinch one hand operation for easier use
- Self locking with release lever
- With locking nut on adjustment knob for pre-setting, ideal for repeated use
- Chrome vanadium with nickel plating

ITEM ID:	L mm	L AF	Cap Width mm	Weight g
409SP	300	12"	88	740



TABLE CLAMP

- Swivel pad for a self levelling grip when clamping
- Non pinch one hand operation for easier use
- Self locking with release lever
- With locking nut on adjustment knob for pre-setting, ideal for repeated use

ITEM ID:	L mm	Clamping Height mm	Clamp Hole mm	Weight g
410SP	230	65	4	580
410P	320	65	10	580

INSULATED TOOLS

PROTECT YOURSELF FROM ELECTRIC SHOCK

All 1000-volt tools from TengTools conform to or exceed all specifications that the relevant authorities have established. Each tool is individually tested before it is marked with a special standard tag and a marking that indicates the year of manufacture.

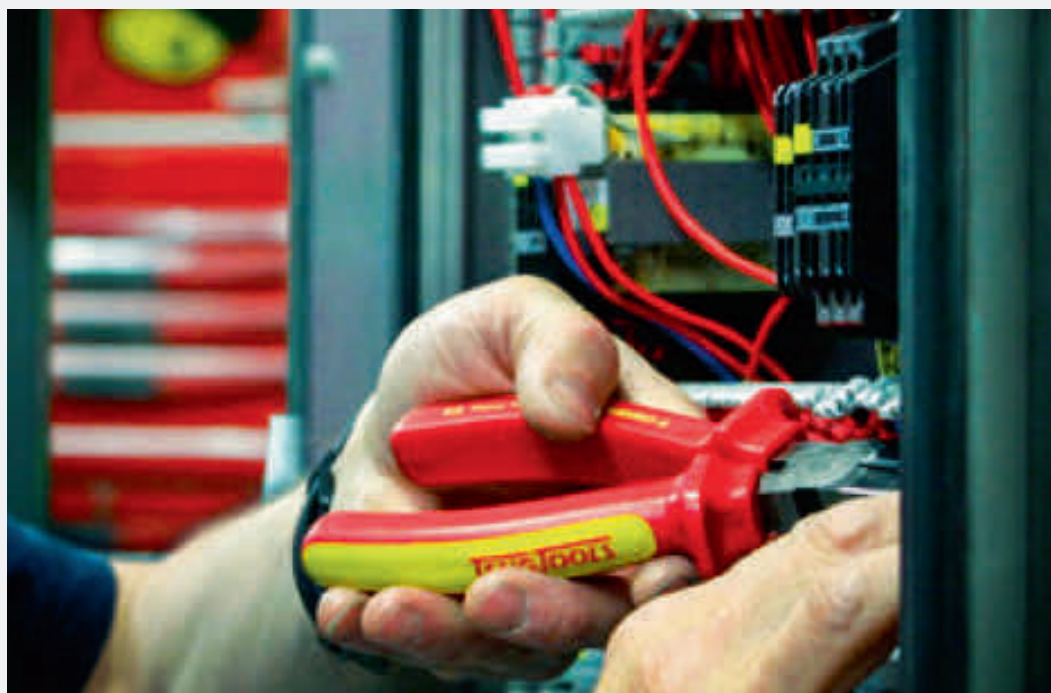

INSULATED SCREWDRIVERS

The bi-material handle is designed for increased comfort and smooth action preventing blisters after continuous use. It gives better support and increased power transfer.

Size and tip marked at the bottom of each handle for easy identification

Integrated protective insulation with two colours to clearly indicate if there is any damage to the insulation

RBD shafts are ultra slim allowing for recessed screws to be accessed easily



TT-MV PLUS steel alloy for greater strength and material flexibility



INSULATED RATCHET

Twist reverse mechanism for quickly changing between tightening and loosening

Insulation made in two parts, yellow insulating core and a red outer layer. Any damage to the insulation can be detected quickly with the visibility of the yellow core layer

72 Teeth ratchet give a working arc of just 5° making it ideal for working in confined spaces

Insulation properties have been tested in resistance to cold and fire as well as in pressurised environments

Ergonomically designed handle for increased comfort and smooth action



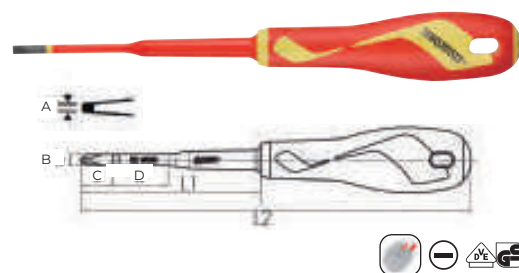

FLAT SLIM INSULATED SCREWDRIVER

- Reduced blade diameter giving an ultra slim blade for easier access
- Approved for live working up to 1,000 volts
- Integrated protective insulation with two colours to clearly indicate if there is any damage to the insulation
- For use with slotted screws
- TT-MV PLUS steel alloy for greater strength and material flexibility
- Ergonomically designed bi-material handle for easy use with higher torque
- Designed and manufactured to DIN 2380 and IEC 60900

ITEM ID:	a mm	b mm	c mm	d mm	Shaft	L1 mm	L2 mm	Weight g	HDL
MDV724N	0.8	4	15	31.5	RBD	101	210	51	M
MDV726N	1	5.5	15	31.5	RBD	127	235	66	M

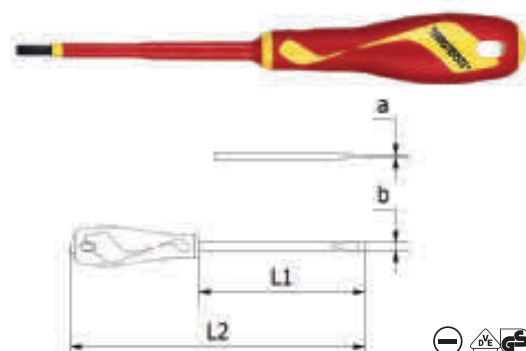

FLAT INSULATED SCREWDRIVER

- Approved for live working up to 1,000 volts
- Integrated protective insulation with two colours to clearly indicate if there is any damage to the insulation
- For use with slotted screws
- TT-MV PLUS steel alloy for greater strength and material flexibility
- Ergonomically designed bi-material handle for easy use with higher torque
- Designed and manufactured to DIN 2380 and IEC 60900

ITEM ID:	a mm	b mm	Shaft	L1 mm	L2 mm	Weight g	HDL
MDV820N	0.4	2.5	Straight	75	171	49	S
MDV822N	0.5	3	Straight	100	196	56	S
MDV823N	0.6	3.5	Straight	100	196	58	S
MDV824N	0.8	4	Straight	100	208	60	M
MDV826N	1	5.5	Straight	125	233	89	M
MDV828N	1.2	6.5	Straight	150	266	135	L

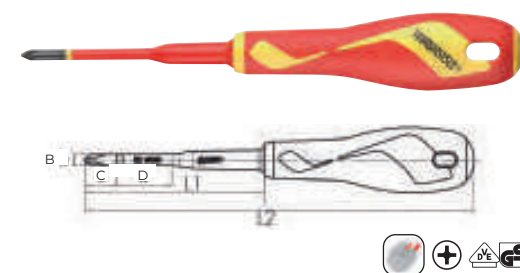

PH SLIM INSULATED SCREWDRIVER

- Reduced blade diameter giving an ultra slim blade for easier access
- Approved for live working up to 1,000 volts
- Integrated protective insulation with two colours to clearly indicate if there is any damage to the insulation
- For use with Phillips type screws
- TT-MV PLUS steel alloy for greater strength and material flexibility
- Ergonomically designed bi-material handle for easy use with higher torque
- Designed and manufactured to DIN 2380 and IEC 60900

ITEM ID:	+	b mm	c mm	d mm	Shaft	L1 mm	L2 mm	Weight g	HDL
MDV742N	PH1	4.5	18	30	RBD	81	190	51	M
MDV744N	PH2	6	18	30.5	RBD	100	217	95	L

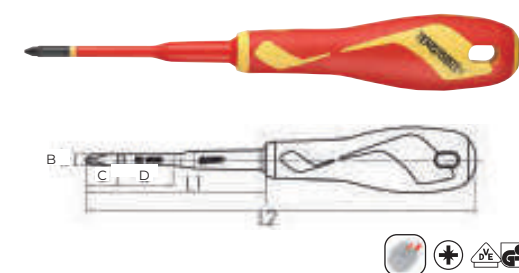

PZ SLIM INSULATED SCREWDRIVER

- Reduced blade diameter giving an ultra slim blade for easier access
- Approved for live working up to 1,000 volts
- Integrated protective insulation with two colours to clearly indicate if there is any damage to the insulation
- For use with Pozidriv type screws
- TT-MV PLUS steel alloy for greater strength and material flexibility
- Ergonomically designed bi-material handle for easy use with higher torque
- Designed and manufactured to DIN 2380 and IEC 60900

ITEM ID:	+	b mm	c mm	d mm	Shaft	L1 mm	L2 mm	Weight g	HDL
MDV762N	PZ1	4.5	18	30	RBD	81	190	51	M
MDV764N	PZ2	6	18	30.5	RBD	100	217	95	L

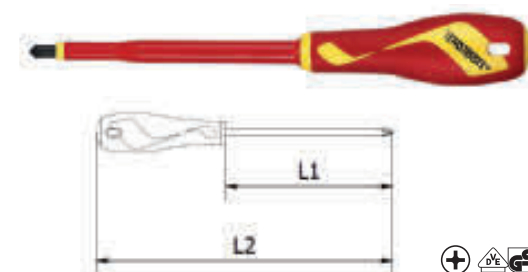

PH INSULATED SCREWDRIVER

- Approved for live working up to 1,000 volts
- Integrated protective insulation with two colours to clearly indicate if there is any damage to the insulation
- For use with Phillips type screws
- TT-MV PLUS steel alloy for greater strength and material flexibility
- Ergonomically designed bi-material handle for easy use with higher torque
- Designed and manufactured to DIN 2380 and IEC 60900

ITEM ID:	+	Shaft	L1 mm	L2 mm	Weight g	HDL
MDV840N	PH0	Straight	60	156	49	S
MDV842N	PH1	Straight	80	188	54	M
MDV844N	PH2	Straight	100	216	118	L
MDV846N	PH3	Straight	150	275	177	XL

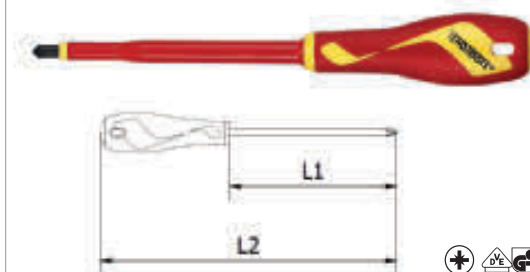

PZ INSULATED SCREWDRIVER

- Approved for live working up to 1,000 volts
- Integrated protective insulation with two colours to clearly indicate if there is any damage to the insulation
- For use with Pozidriv type screws
- TT-MV PLUS steel alloy for greater strength and material flexibility
- Ergonomically designed bi-material handle for easy use with higher torque
- Designed and manufactured to DIN 2380 and IEC 60900

ITEM ID:	+	Shaft	L1 mm	L2 mm	Weight g	HDL
MDV860N	PZ0	Straight	60	156	49	S
MDV862N	PZ1	Straight	80	188	54	M
MDV864N	PZ2	Straight	100	216	118	L
MDV866N	PZ3	Straight	150	275	177	XL

Insulated according to IEC 60900, usable up to 1000 V
 VDE tested, also in conformance to GPSG (Equipment and Product Safety Act)

Reduced blade diameter (RBD)



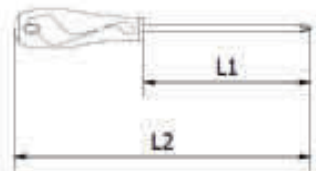

FLAT/PH INSULATED SCREWDRIVER

- Approved for live working up to 1,000 volts
- Integrated protective insulation with two colours to clearly indicate if there is any damage to the insulation
- TT-MV PLUS steel alloy for greater strength and material flexibility
- Ergonomically designed bi-material handle for easy use with higher torque
- Designed and manufactured to IEC 60900

ITEM ID:	+	Shaft	L1 mm	L2 mm	Weight g	HDL
MDV844NF	Slotted/PH2	Straight	100	216	118	L
MDV864NF	Slotted/PZ2	Straight	100	216	118	L

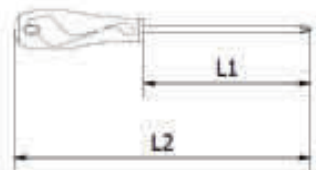

ROB INSULATED SCREWDRIVER

- Approved for live working up to 1,000 volts
- Integrated protective insulation with two colours to clearly indicate if there is any damage to the insulation
- For use with ROB type screws with a square hole
- TT-MV PLUS steel alloy for greater strength and material flexibility
- Ergonomically designed bi-material handle for easy use with higher torque
- Designed and manufactured to IEC 60900

ITEM ID:	⊖	Shaft	L1 mm	L2 mm	Weight g	HDL
MDV802N	ROB2	Straight	100	216	118	L

- Insulated according to IEC 60900, usable up to 1000 V
VDE tested, also in conformance to GPSG (Equipment and Product Safety Act)
- Reduced blade diameter (RBD)



LARGE INSULATED HANDLE FOR INTERCHANGEABLE BLADES

- Approved for live working up to 1,000 volts
- Integrated protective insulation with two colours to clearly indicate if there is any damage to the insulation
- For use 1000V interchangeable blades
- Ergonomically designed bi-material handle for easy use with higher torque
- Designed and manufactured to IEC 60900

ITEM ID:	Length mm	Height mm	Width mm	Weight g	HDL
MDV700	122	36.7	37	66 g	L



SMALL INSULATED HANDLE FOR INTERCHANGEABLE BLADES

- Approved for live working up to 1,000 volts
- Integrated protective insulation with two colours to clearly indicate if there is any damage to the insulation
- For use 1000V interchangeable blades
- Ergonomically designed bi-material handle for easy use with higher torque
- Designed and manufactured to IEC 60900

ITEM ID:	Length mm	Height mm	Width mm	Weight g	HDL
MDV710	100	23	23	26g	S



INSULATED INTERCHANGE-ABLE SCREWDRIVERS BLADES

- Approved for live working up to 1,000 volts
- For use with 1000V handles
- Designed and manufactured to IEC 60900

ITEM ID:	Tip	Shaft	Length mm	Height mm	Width mm	Weight g	
MDV731	⊖	3	Straight	111	13	13	9 g
MDV732	⊖	4	RBD	151	13	13	15 g
MDV733	⊖	5.5	RBD	131	13	13	21 g
MDV734	⊖	6.5	RBD	151	13	13	28 g
MDV751	+	PH1	RBD	131	13	13	15 g
MDV752	+	PH2	RBD	151	13	13	26 g
MDV771	+	PZ1	RBD	131	13	13	15 g
MDV772	+	PZ2	RBD	151	13	13	26 g



INSULATED SCREWDRIVER BLADE SET TTI

- Interchangeable blades for a wide range of tips in one set
- Approved for live working up to 1,000 volts
- Designed and manufactured to DIN ISO 2380, DIN ISO 8764-1 and IEC 60900

Insulated handles: 22x100mm, 37x122mm			
1000V Insulated Screwdriver blades:			
⊖	Reg mm:	3 x 70	
⊖	Slim mm:	4 x 100	5.5 x 80 6.5 x 100
+	Slim mm:	PH1 x 80	PH2 x 100
+	Slim mm:	PZ1 x 80	PZ2 x 100

Item ID: **TTV710N**



INSULATED SCREWDRIVER SET MIXED TTI

- Approved for live working up to 1,000 volts
- Integrated protective insulation with two colours to clearly indicate if there is any damage
- Designed and manufactured to DIN ISO 2380, DIN ISO 8764-1 and IEC 60900

1000V Insulated Screwdrivers:			
⊖	mm:	4 x 100	5.5 x 125
+	mm:	PH1 x 80	PH2 x 100
+	mm:	PZ1 x 80	PZ2 x 100

Item ID: **TTV706N**



INSULATED SCREWDRIVER SET MIXED TTI

- Approved for live working up to 1,000 volts
- Integrated protective insulation with two colours to clearly indicate if there is any damage
- Designed and manufactured to DIN ISO 2380, DIN ISO 8764-1 and IEC 60900

1000V Insulated Screwdrivers:			
⊖	mm:	2.5 x 75	4 x 100 5.5 x 125
+	mm:	PH0 x 60	PH1 x 80 PH2 x 100
+	mm:	PZ2 x 100	

Item ID: **TTV907N**



TT
SERIES
2



INSULATED SCREWDRIVER SET MIXED TT2

- Approved for live working up to 1,000 volts
- Integrated protective insulation with two colours to clearly indicate if there is any damage
- Designed and manufactured to DIN ISO 2380, DIN ISO 8764-1 and IEC 60900

1000V Insulated Screwdrivers:					
⊖	mm:	2.5 x 75	3 x 100	4 x 100	5.5 x 125
⊕	mm:	PH0 x 60	PH1 x 80	PH2 x 100	
⊕	mm:	PZ0 x 60	PZ1 x 80	PZ2 x 100	

Item ID: **TTDV910N**



FOAM
SERIES
2



INSULATED SCREWDRIVER SET MIXED FOAM2

- Approved for live working up to 1,000 volts
- Integrated protective insulation with two colours to clearly indicate if there is any damage
- A 100-250 volt tester is also included for checking circuits
- Tools are held in place using three colour pre-cut EVA foam
- Designed and manufactured to DIN ISO 8764-1, DIN ISO 2380 and IEC 60900

100-250V Voltage Tester					
1000V Insulated Screwdrivers:					
⊖	mm:	2.5 x 75	3 x 100	4 x 100	5.5 x 125
⊕	mm:	PH0 x 60	PH1 x 80	PH2 x 100	
⊕	mm:	PZ2 x 100			

Item ID: **TEDV909N**

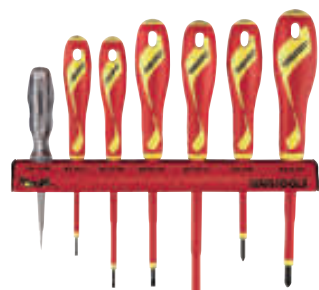

INSULATED SCREWDRIVER FLAT & PH WALL RACK

- Approved for live working up to 1,000 volts
- Protective insulation with two colours to clearly indicate if there is any damage to the insulation
- Supplied with a wall rack for fixing to the wall or a workbench
- Designed and manufactured to DIN ISO 2380, DIN ISO 8764-1 and IEC60900

105 - 250V Voltage Tester					
1000V Insulated Screwdrivers:					
⊖	mm:	2.5 x 75	3 x 100	4 x 100	5.5 x 125
⊕	mm:	PH1 x 80	PH2 x 100		

Item ID: **WRMDV07N**



INSULATED SCREWDRIVER MIXED WALL RACK

- Approved for live working up to 1,000 volts
- Protective insulation with two colours to clearly indicate if there is any damage to the insulation
- Supplied with a wall rack for fixing to the wall or a workbench
- Designed and manufactured to DIN ISO 2380, DIN ISO 8764-1 and IEC60900

1000V Insulated Screwdrivers:					
⊖	mm:	3 x 100	5.5 x 125		
⊕	mm:	PH1 x 80	PH2 x 100		
⊕	mm:	PZ2 x 100			

Item ID: **WRMDV05N**



INSULATED SCREWDRIVER SET FLAT & PH

- Approved for live working up to 1,000 volts
- Integrated protective insulation with two colours to clearly indicate if there is any damage to the insulation
- Designed and manufactured to DIN ISO 2380, DIN ISO 8764 and IEC60900

1000V Insulated Screwdrivers:					
⊖	mm:	2.5 x 75	3 x 100	4 x 100	5.5 x 125
⊕	mm:	PH1 x 80	PH2 x 100		

Item ID: **MDV906N**

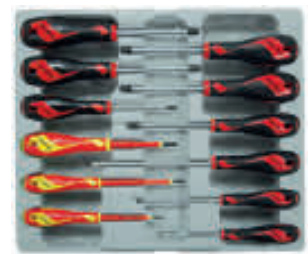

SCREWDRIVER SET MIXED & INSULATED

- TT-MV PLUS steel alloy for greater strength and material flexibility
- Ergonomically designed bi-material handle for easy use with higher torque and faster speed
- Hole in the handle for hanging or for use as a T handle for extra torque or with a fall protection wire if needed
- The handle is moulded around the blade to ensure straightness and to allow larger blade wings which give a higher torque capacity
- Supplied in a full colour display box with PS tray

Screwdrivers:					
⊖	mm:	2.5 x 75	3.5 x 100	5.5 x 150	
⊖	mm:	2.5 x 75	3.0 x 100		
⊕	mm:	PH1 x 75	PH1 x 80		
⊕	mm:	PH2 x 100			
⊕	mm:	PZ2 x 100			
⊕	mm:	TX20 x 100	TX25 x 100	TX30 x 100	

Item ID: **MD912N1**



What are our insulated tools tested for?

- Insulation properties, i.e. resistance up to 1000 volts in dry or humid environments.
- Resistance to the cold, i.e. how well the tool withstands the cold
- Durability, i.e. that the insulating handles do not come loose
- Resistance to fire, i.e. how well the tool withstands fire
- Insulating properties under pressure, i.e. how well the tool maintains its insulating properties when subjected to pressure

Insulated according to IEC 60900, usable up to 1000 V
VDE tested, also in conformance to GPSG (Equipment and Product Safety Act)
Reduced blade diameter (RBD)



NEW



1/4" INSULATED TORQUE SCREWDRIVER 1-5NM

- Approved for live working up to 1,000 volts
- Torque screwdriver covering 1-5Nm for our VDE interchangeable blades
- Slipper mechanism ensures that no torque is applied beyond the set torque
- Simple to adjust and easy to read window Nm scale
- Twist locking facility to ensure the set torque is maintained
- Accurate to +/- 6% and conforms to ISO6789 for assured reliability and accuracy
- Individually tested and certified at the time of manufacture
- Each torque wrench has it's own individual certification number for easier quality control management
- Design and manufactured to IEC 60900

ITEM ID:	Range Nm
1492TVSD	1-5

NEW



TT SERIES

9 Pieces



1000V TORQUE SCREWDRIVER BLADE SET TTI

- Slim blades with reduced blade diameter for easier access to recessed screws and spring elements
- Approved for live working up to 1,000 volts
- Designed and manufactured to IEC 60900

Torque Screwdriver 1/4 in 1-5Nm 1000V			
1000V Insulated Screwdriver blades:			
Reg mm:	3 x 70		
Slim mm:	4 x 100	5.5 x 80	6.5 x 100
Slim mm:	PH1 x 80	PH2 x 100	
Slim mm:	PZ1 x 80	PZ2 x 100	

Item ID: TTVSD09

NEW



TT SERIES

9 Pieces



TORQUE SCREWDRIVER BLADE SET FOAMI

- Slim blades with reduced blade diameter for easier access to recessed screws and spring elements
- Approved for live working up to 1,000 volts
- Tools are hold in place using three colour pre-cut EVA foam
- Designed and manufactured to IEC60900

Torque Screwdriver 1/4 in 1-5Nm 1000V			
1000V Insulated Screwdriver blades:			
Reg mm:	3 x 70		
Slim mm:	4 x 100	5.5 x 80	6.5 x 100
Slim mm:	PH1 x 80	PH2 x 100	
Slim mm:	PZ1 x 80	PZ2 x 100	

Item ID: TEAVSD09



INSULATED SIDE CUTTING PLIER

- Approved for live working up to 1,000 volts
- Chrome molybdenum steel
- 80° cutting edge angle
- Electricians style function
- TPR grip for a more secure and comfortable grip
- Designed and manufactured to DIN5749 and IEC60900

ITEM ID:	Length		GRIP	Cutting Capacity mm			Weight g
	AF	mm		●	◐	◑	
MBV441-6	6"	150	TPR	1.6	2.0	2.5	206



HEAVY DUTY INSULATED SIDE CUTTING PLIER

- Approved for live working up to 1,000 volts
- Chrome molybdenum steel
- 80° cutting edge angle
- High leverage function for increased cutting capacity
- TPR grip for a more secure and comfortable grip
- Designed and manufactured to DIN5749 and IEC60900

ITEM ID:	Length		GRIP	Cutting Capacity mm			Weight g
	AF	mm		●	◐	◑	
MBV442-8	8"	200	TPR	2.5	3.0	4.0	305



INSULATED COMBINATION PLIER

- Approved for live working up to 1,000 volts
- Features a pipe grip with serrated jaw for a more secure grip
- Chrome molybdenum alloy steel for durability and strength
- 80° cutting edge angle
- TPR grip for a more secure and comfortable grip
- Designed and manufactured to DIN5746 and IEC60900

ITEM ID:	Length		GRIP	Cutting Capacity mm			Weight g
	AF	mm		●	◐	◑	
MBV451-7	7"	175	TPR	1.8	2.0	3.8	225
MBV451-8	8"	200	TPR	2.0	2.2	4.0	283



INSULATED LONG NOSE PLIER

- Approved for live working up to 1,000 volts
- Long straight jaws for easier access
- Jaws with a serrated grip for increased gripping power
- Chrome molybdenum alloy steel for durability and strength
- 80° cutting edge angle
- TPR grip for a more secure and comfortable grip
- Designed and manufactured to DIN5745 and IEC60900

ITEM ID:	Length		GRIP	Cutting Capacity mm			Weight g
	AF	mm		●	◐	◑	
MBV461-8	8"	200	TPR	1.5	1.8	2.8	199

Insulated according to IEC 60900, usable up to 1000 V

VDE tested, also in conformance to GPSC (Equipment and Product Safety Act)

- Piano Wire
- Hard Wire
- Medium Hard Wire



INSULATED WIRE STRIPPING PLIER

- 7" 1,000 volt insulated wire stripping pliers
- Approved for live working up to 1,000 volts
- Medium carbon alloy steel construction
- With adjuster screw to suit wire diameters from 0.2 to 4.5mm
- Return spring for easier operation
- TPR grip for a more secure and comfortable grip
- Designed and manufactured to IEC 60900

ITEM ID:	Length		AF	Cutting Capacity mm		Weight g
	mm	GRIP		mm	g	
MBV499-7	6"	155	TPR	0.2 - 4.5	175	



INSULATED PLIER SET TTI 4 PIECES

- Approved for live working up to 1,000 volts
- TPR grip for a more secure and comfortable grip
- Designed and manufactured to DIN5745, DIN5746, DIN5749 and IEC 60900

1000V Insulated Pliers:	
SIDE CUTTER	6" / 150 mm
LONG NOSE	8" / 200 mm
COMBINATION PLIERS	7" / 175 mm
WIRE STRIPPING PLIERS	6" / 155 mm

Item ID: **TTV440**



INSULATED PLIER SET FOAM2 4 PIECES

- Approved for live working up to 1,000 volts
- TPR grip for a more secure and comfortable grip
- Tools are held in place using three colour pre-cut EVA foam
- Designed and manufactured to DIN5745, DIN5746, DIN5749 and IEC 60900

1000V Insulated Pliers:	
SIDE CUTTER	6" / 150 mm
LONG NOSE	8" / 200 mm
COMBINATION PLIERS	8" / 200 mm
WIRE STRIPPING PLIERS	6" / 155 mm

Item ID: **TEDV440**

Insulated according to IEC 60900, usable up to 1000 V
VDE tested, also in conformance to GPSC (Equipment and Product Safety Act)

- Piano Wire
- Hard Wire
- Medium Hard Wire

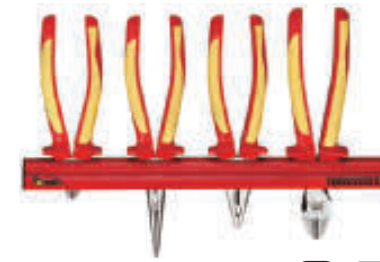

INSULATED PLIER SET WALL RACK 4 PIECES

- Approved for live working up to 1,000 volts
- TPR grip for a more secure and comfortable grip
- Supplied with a wall rack for fixing to the wall or a workbench
- Designed and manufactured to DIN5745, DIN5746, DIN5749 and IEC60900

1000V Insulated Pliers:	
SIDE CUTTER	6" / 150 mm
HEAVY DUTY SIDE CUTTERS	8" / 200 mm
LONG NOSE	8" / 200 mm
COMBINATION PLIERS	7" / 175 mm

Item ID: **WRMBV04**



Manufactured to the highest standard

IEC 60 900 is an international standard for testing tools designed for electrical work on the production line

DIN EN 60900 is a European standard drawn up in 1995 and which states that each individual tool must be tested with regard to insulation for 1000 volts

VDE is an independent authority that tests and checks tools with regard to construction, production and packaging



MECCA PRO INSULATED SCREWDRIVER & PLIER SET 18 PIECES

- Approved for live working up to 1,000 volts
- Screwdrivers with Integrated protective insulation with two colours to clearly indicate if there is any damage to the insulation
- TPR grip on the pliers and bi-material handles on the screwdrivers for a more secure and comfortable grip
- Hard wearing case with tools laid out to easily identify where tools belong
- Secure lock system to ensure that the lid is closed correctly
- Designed and manufactured to IEC 60900

1000V Screwdrivers:						
	mm:	2.5 x 75	3 x 100	4 x 100	5.5 x 125	6.5 x 150
	mm:	PH0 x 60	PH1 x 80	PH2 x 100	PH3 x 150	
	mm:	PZ0 x 60	PZ1 x 80	PZ2 x 100	PZ3 x 150	

1000V Pliers:	
6" side cutters, 8" heavy duty side cutters, 8" combination, 8" long nose, 7" wire strippers	

Item ID: **TV18N**



NEW



3/8" DRIVE INSULATED RATCHET

- Approved for live working up to 1,000 volts
- 72 teeth giving 5 degree increments between clicks
- Twist reverse for quickly and easily changing between tightening and loosening
- Design and manufactured to DIN3122D and IEC60900

ITEM ID:	Drive	Reverse	No. of Teeth	Length mm	Weight g
MV3800	3/8"	Twist	72	200	343

NEW



3/8" DRIVE INSULATED EXTENSION BAR

- Approved for live working up to 1,000 volts
- Integrated protective insulation with two colours to clearly indicate if there is any damage
- Ball recess on the female end to grip the ratchet
- Ball socket retainer on the male end to securely grip the socket
- Chrome vanadium
- Design and manufactured to DIN3123B and IEC60900

ITEM ID:	Drive	Length mm	Weight g
MV380020	3/8"	91	77
MV380021	3/8"	166	135

NEW



3/8" DRIVE INSULATED SOCKETS

- Approved for live working up to 1,000 volts
- Integrated protective insulation with two colours to clearly indicate if there is any damage
- 6 point single hexagon socket for a better grip
- Chrome vanadium
- Ball recess on the female end to grip the ratchet
- Design and manufactured to DIN3120/3124, ISO2725 and IEC 60900

ITEM ID:	Size mm	L mm	D1 mm	D2 mm	Weight g
MV380506	6	46	14.8	23	29
MV380507	7	46	15.7	23	29
MV380508	8	46	17	23	30
MV380509	9	46	18.2	23	31
MV380510	10	46	19.4	23	31
MV380511	11	46	20.7	23	32
MV380512	12	46	23	23	33
MV380513	13	46	23	23	37
MV380514	14	46	24.7	23	39
MV380515	15	46	26	23	40
MV380516	16	46	26.8	23	42
MV380517	17	46	29	23	47
MV380518	18	46	29.6	23	49
MV380519	19	46	30.7	23	53
MV380520	20	46	32.2	23	55

NEW

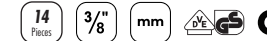

INSULATED SOCKET SET 3/8" DRIVE TTI

- Approved for live working up to 1,000 volts
- 6 point single hexagon socket for a better grip
- Integrated protective insulation with two colours to clearly indicate if there is any damage to the insulation
- Designed and manufactured to DIN, ISO and IEC 60900

3/8" Drive Insulated Ratchet	
6" Insulated Extension bar	
Regular 6 point Insulated sockets:	
mm:	8 9 10 11 12 13
	14 15 16 17 18 19

Item ID: **TTV3814**

NEW



INSULATED SOCKET SET 3/8" DRIVE 18 PIECES

- Approved for live working up to 1,000 volts
- 6 point single hexagon socket for a better grip
- Integrated protective insulation with two colours to clearly indicate if there is any damage to the insulation
- Tools are hold in place using three colour pre-cut EVA foam clearly showing where each tools belongs
- Designed and manufactured to DIN, ISO and IEC 60900 standards

3/8" Drive Insulated Ratchet	
3" and 6" Insulated Extension bars	
Regular 6 point Insulated sockets:	
mm:	6 7 8 9 10 11 12 13
	14 15 16 17 18 19 20

Item ID: **TEDV3818**

1000V



1000V



CUTTING TOOLS

ACCURACY, EFFICIENCY, AND SPEED

Selecting the right cutting tool for the correct application is vital to complete the task safely and efficiently. From snap off blade knives to tin snips and hacksaws to tap & die sets we have the tools you will need here.



HIGH LEVERAGE TIN SNIPS

Chrome molybdenum alloy steel drop forged cutting blades for extra strength

Cuts up to 1.5mm cold rolled steel or 0.9mm stainless steel

Spring loaded high leverage handles for increased cutting capacity

Double spring with high torsional strength for frequent use

Safety lock for safe storage

Bi-material grip for more comfortable use



HACKSAW

12" Swedish steel M2 HSS 24 teeth blade for consistent quality

Includes facility for presetting at a 45° or 90° cutting angles

Soft rubber grip area on the handle and frame for a better grip

Ergonomically designed aluminium handle



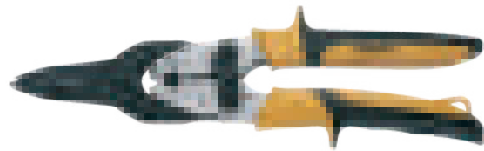

STRAIGHT CUT TIN SNIPS

- Chrome molybdenum alloy steel drop forged cutting blades
- Cuts up to 1.5mm steel or 0.9mm stainless steel
- Spring loaded high leverage handles for increased cutting capacity
- Safety lock for safe storage
- Bi-material grip for more comfortable use

ITEM ID:	Length	Type	Handle	Steel mm	Stainless Steel mm
490	10"	Straight	Yellow	1.5	0.9



STRAIGHT/LEFT CUT TIN SNIPS

- Chrome molybdenum alloy steel drop forged cutting blades
- Cuts up to 1.5mm steel or 0.9mm stainless steel
- Blade angle designed to cut towards the left when cutting curves
- Also cuts in a straight line
- Spring loaded high leverage handles for increased cutting capacity
- Safety lock for safe storage
- Bi-material grip for more comfortable use

ITEM ID:	Length	Type	Handle	Steel mm	Stainless Steel mm
492	10"	Straight/Left	Red	1.5	0.9



STRAIGHT/RIGHT CUT TIN SNIPS

- Chrome molybdenum alloy steel drop forged cutting blades
- Cuts up to 1.5mm steel or 0.9mm stainless steel
- Blade angle designed to cut towards the right when cutting curves
- Also cuts in a straight line
- Spring loaded high leverage handles for increased cutting capacity
- Safety lock for safe storage
- Bi-material grip for more comfortable use

ITEM ID:	Length	Type	Handle	Steel mm	Stainless Steel mm
491	10"	Straight/Right	Grey	1.5	0.9



OFF SET STRAIGHT/RIGHT TIN SNIPS

- Cuts up to 1.5mm steel or 0.9mm stainless steel
- Blade angle designed to cut towards the right when cutting curves
- Also cuts in a straight line
- Bi-material grip for more comfortable use

ITEM ID:	Length	Type	Steel mm	Stainless Steel mm
493	10"	Off set/Right	1.5	0.9



OFF SET STRAIGHT/LEFT TIN SNIPS

- Cuts up to 1.5mm steel or 0.9mm stainless steel
- Blade angle designed to cut towards the right when cutting curves
- Also cuts in a straight line
- Bi-material grip for more comfortable use

ITEM ID:	Length	Type	Steel mm	Stainless Steel mm
494	10"	Off set/Left	1.5	0.9



LONG BLADE STRAIGHT CUT TIN SNIPS

- Chrome molybdenum alloy steel drop forged cutting blades
- Cuts up to 0.9mm cold rolled steel or 0.53mm stainless steel
- Spring loaded high leverage handles for increased cutting capacity
- Safety lock for safe storage
- Bi-material grip for more comfortable use

ITEM ID:	Length	Type	Steel mm	Stainless Steel mm
495	11"	Straight/Long cut	0.9	0.53



HIGH LEVERAGE STRAIGHT CUT TIN SNIPS

- Chrome molybdenum alloy steel drop forged cutting blades
- Cuts up to 1.5mm cold rolled steel or 0.9mm stainless steel
- Spring loaded high leverage handles for increased cutting capacity
- Double spring with high torsional strength for frequent use
- Safety lock for safe storage
- Ergonomically designed handle for more comfortable use

ITEM ID:	Length	Type	Copper mm	Steel mm	Hard Steel mm	Stainless Steel mm
490W	10"	Straight	1.8	1.5	1	0.9



HIGH LEVERAGE RIGHT/STRAIGHT CUT TIN SNIPS

- Chrome molybdenum alloy steel drop forged cutting blades
- Cuts up to 1.5mm cold rolled steel or 0.9mm stainless steel
- Blade angle designed to cut towards the right when cutting curves
- Also cuts in a straight line
- Spring loaded high leverage handles for increased cutting capacity
- Double spring with high torsional strength for frequent use
- Safety lock for safe storage
- Ergonomically designed handle for more comfortable use

ITEM ID:	Length	Type	Copper mm	Steel mm	Hard Steel mm	Stainless Steel mm
491W	10"	Straight/Right	1.8	1.5	1	0.9



HIGH LEVERAGE LEFT/STRAIGHT CUT TIN SNIPS

- Chrome molybdenum alloy steel drop forged cutting blades
- Cuts up to 1.5mm cold rolled steel or 0.9mm stainless steel
- Blade angle designed to cut towards the left when cutting curves
- Also cuts in a straight line
- Spring loaded high leverage handles for increased cutting capacity
- Double spring with high torsional strength for frequent use
- Safety lock for safe storage
- Ergonomically designed handle for more comfortable use

ITEM ID:	Length	Type	Copper mm	Steel mm	Hard Steel mm	Stainless Steel mm
492W	10"	Straight/Left	1.8	1.5	1	0.9

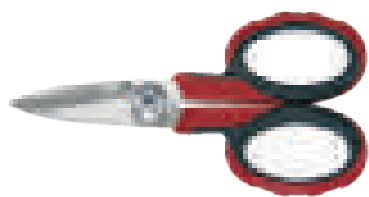

SCISSOR

- High carbon stainless steel blades for accurate cutting
- Cutting capacity of 22mm in soft materials
- Bi-material grip for added comfort

ITEM ID:	Length mm	Blade Length mm	Capacity mm
497	138	42	22



INTRICATE CUTTING SCISSOR

- Straight cutting jaws
- Sharp cutting edge
- Special grade stainless steel
- Hot drop forged for strength
- Matt finish

ITEM ID:	Length mm	Blade Type	Weight g
SR1160	160	straight, sharp	61
SR1180	180	straight, sharp	77
SR2180	180	straight, blunt	69
SR3160	160	curved, sharp	61



TT
SERIES

2

5
Pieces

CUTTING TOOL SET TT2 5 PIECES

- Includes high leverage tin snips for straight, left and right cutting
- Utility knife with retractable blade and ergonomic grip
- High carbon stainless steel blade industrial scissors
- Heavy duty cable cutters with compound leverage for easier cutting

Cutting Tools:

Tin snips (straight/left & straight/right), utility knife, scissors, heavy duty cable cutters

Item ID: **TTDCT05**



HACKSAW

- Ergonomically designed aluminium handle
- Soft rubber grip area on the handle and frame for a better grip
- 12" Swedish steel M2 HSS 24 TPI blade for consistent quality
- Includes facility for presetting at a 45° or 90° cutting angles

ITEM ID:	Description
701N1	Hacksaw frame
702	2 spare 24 teeth blades



HACKSAW

- Ergonomically designed curved aluminium handle
- Soft rubber grip area on the handle and frame for a better grip
- 12" Swedish steel M2 HSS 24 TPI blade for consistent quality
- Includes facility for presetting at a 45° or 90° cutting angles

ITEM ID:	Description
701N	Hacksaw frame
702	2 spare 24 teeth blades



HACKSAW

- Ergonomically designed aluminium handle for a better grip
- 12" Swedish steel M2 HSS 24 TPI blade for consistent quality
- Includes facility for presetting at a 45° or 90° cutting angles
- Key hole saw facility for cutting in to holes
- Includes storage space for extra blades in the handle

ITEM ID:	Description
701	Hacksaw frame
702	2 spare 24 teeth blades



MINI HACKSAW

- 6 blade positions for cutting up, down or sideways
- Supplied with 3 TengTools 6" mini hacksaw blades

ITEM ID:	Description
705	Mini hacksaw frame
705-5	5 spare blades



MINI HACKSAW

- Cast aluminium strong frame construction
- Ergonomic rubber grip on the handle for more comfortable use
- Suitable for use with 16 and 24 TPI blades for cutting metal or wood
- One of each blade included

ITEM ID:	Description
705A	Mini hacksaw frame
705A-5	16 teeth blade for wood
705-5	5 spare blades



HACKSAW BLADE HOLDER

- Plastic with a non slip handle
- Suitable for use with any standard 12" hacksaw blades
- Supplied with a TengTools 12" hacksaw blade
- Ideal for use as a key hole saw

Item ID: **704**



GUN SAW SET

- Ergonomically designed pistol style grip
- 4 blade positions for cutting up, down or sideways
- Supplied with a 24 TPI blade for cutting metal
- Supplied with a 10 TPI blade for cutting wood, plastics, etc.

ITEM ID:	Description
703	Gun saw set
703-10	10 teeth blade for wood/plastic
703-24	24 teeth blade for metal



3 Pieces

HACKSAW AND KNIFE SET

- Professional quality hacksaws for technicians and engineers

Contents:
12" Hacksaw
Junior Hacksaw
Utility Knife

Item ID: **700-PRO5**



SNAP OFF KNIFE 9 MM

- Metal casing with a break off tool for removing blunt blade sections
- Sliding blade holder to retract blade when not in use
- Handy pocket clip

ITEM ID:	Description
710A	Hobby Knife
710A-10	10 spare 9mm blades



HOBBY KNIFE WITH 9MM BLADE

- Plastic casing with a break off tool for removing blunt blade sections
- Slide incorporates a locking mechanism to lock the blade in place at any position, in or out
- Sliding metal blade holder to retract blade when not in use
- Handy pocket clip

ITEM ID:	Description
710H	Hobby Knife
710A-10	10 spare 9mm blades



HOBBY KNIFE WITH 9MM BLADE

- Plastic casing with a break off tool for removing blunt blade sections
- Sliding metal blade holder to retract blade when not in use
- Handy pocket clip
- Supplied with 2 spare blades

ITEM ID:	Description
710F	Hobby Knife
710A-10	10 spare 9mm blades



SNAP OFF KNIFE 18 MM

- Plastic casing with a break off tool for removing blunt blade sections
- Slide locking mechanism to lock the blade in place at any position, in or out
- Sliding metal blade holder to retract blade when not in use
- Handy pocket clip

ITEM ID:	Description
710C	Hobby Knife
710F-10	10 spare 18mm blades



HOBBY KNIFE WITH 18MM BLADE

- Plastic casing with a break off tool for removing blunt blade sections
- Slide locking mechanism to lock the blade in place at any position, in or out
- Sliding metal blade holder to retract blade when not in use
- Handy pocket clip
- Supplied with two 18mm snap off blades

ITEM ID:	Description
710G	Hobby Knife
710F-10	10 spare 18mm blades

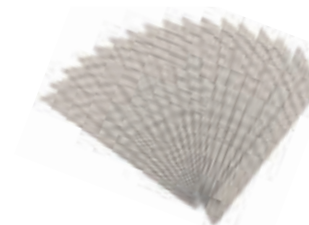

SPARE BLADES

- Spare 9mm break off blades for TengTools craft knives
- Pack of 100 blades

Item ID: **710A-100**



SPARE BLADES

- Spare 18mm break off blades for TengTools craft knives
- Pack of 100 blades

Item ID: **710F-100**



4 Pieces

SNAP OFF KNIFE SET 4 PIECES

- 2 knives with 9mm snap off blades and 2 with 18mm snap off blades

Contents:
9mm blade with metal body
9mm blade with plastic body
18mm blade with plastic body
18mm blade with plastic body and position lock

Item ID: **710S**



MINI FOLDING UTILITY KNIFE

- Knife folds away in to a pocket knife
- Locking mechanism prevents accidental opening of the knife
- Retractable blade with simple slide action for changing blades

ITEM ID:	Description
P-UKF	Utility knife
710U-10	10 spare blades



QUICK ACTION UTILITY KNIFE

- Ergonomically designed handle with soft non slip grip area
- Retractable 3 step blade for safer use and storage
- Storage for spare blades with quick opening and closing action
- Supplied with 2 spare TengTools blades

ITEM ID:	Description
710N	Utility knife
710-10	10 spare blades



FOLDING UTILITY KNIFE

- Knife folds away in to a pocket knife
- Locking mechanism prevents accidental opening of the knife
- Retractable blade with simple slide action for changing blades
- Supplied with 3 TengTools utility knife blades

ITEM ID:	Description
712	Utility knife
710-10	10 spare blades



SAFETY UTILITY KNIFE

- Bi-material plastic handle for a more comfortable grip
- Non slip grip area for a more secure grip
- Features an automatic blade return mechanism
- Handy release button for quickly and easily ejecting used blades
- Replacement blade automatically inserted from the internal storage section
- Supplied with 6 blades stored in the handle

ITEM ID:	Description
711	Utility knife
710-10	10 spare blades



UTILITY KNIFE

- Retractable blade for safer use and storage
- Storage for spare blades with screw lock access
- Supplied with 2 spare TengTools blades

ITEM ID:	Description
710	Utility knife
710-10	10 spare blades



SPARE BLADES

- Spare blades for TengTools utility knives
- Pack of 100 blades with storage for used blades

Item ID: **710-100**



DRILL BITS FULLY GROUND

- Fully ground drill bit
- Standard drill bits for use in steel and cast iron, etc
- Spiral angle of 28° to expel swarf etc
- Point angle of 118° and a split point for better positional accuracy
- Designed and manufactured to DIN338

ITEM ID:	Size mm	Flute Length mm	Overall Length mm	Pack Qty
DBX010	1	12	34	10
DBX015	1.5	18	40	10
DBX020	2	24	49	10
DBX025	2.5	30	57	10
DBX030	3	33	61	10
DBX033	3.3	36	65	10
DBX035	3.5	39	70	10
DBX040	4	43	75	10
DBX042	4.2	43	75	10
DBX045	4.5	47	80	10
DBX050	5	52	86	10
DBX055	5.5	57	93	10
DBX060	6	57	93	10
DBX065	6.5	63	101	10
DBX068	6.8	69	109	10
DBX070	7	69	109	10
DBX075	7.5	69	109	10
DBX080	8	75	117	5
DBX085	8.5	75	117	5
DBX090	9	81	125	5
DBX095	9.5	81	125	5
DBX100	10	87	133	5
DBX105	10.5	87	133	5
DBX110	11	94	142	5
DBX115	11.5	94	142	5
DBX120	12	101	151	5
DBX125	12.5	101	151	5
DBX130	13	101	151	5



SPARE BLADES

- Spare hook type blades for TengTools utility knives
- Pack of 10 blades with storage for used blades

Item ID: **710-10H**



REPLACEMENT HOOK BLADES UTILITY KNIFE

- Spare hook type blades for TengTools utility knives
- Pack of 100 blades with storage for used blades

Item ID: **710-100H**



TT
SERIES

40
Pieces

KNIFE SET TTI 40 PIECES

- Includes a selection of different knives to suit all types of use
- Spare blades included for each type of knife

Knives:
Utility knife with auto load function, folding universal knife, folding mini utility knife, hobby knife with 9mm blade, hobby knife with 18mm blade

Spare blades:
5 x Regular knife blades, 10 x Mini knife blades, 10 x 9mm Snap off blades, 10 x 18mm Snap off blades

Item ID: **TTK40**



TT
SERIES

28
Pieces

DRILL BIT SET 1.0-13.0 MM TT1 28 PIECES

- Standard drill bits for use with steel and cast iron, etc.
- Spiral angle of 28° for clean cutting
- Split point angle of 118° for better positioning
- Shank the same diameter as the tip
- Designed and manufactured to DIN338

Fully Ground Drill Bits:

1.0 (x3), 1.5 (x3), 2.0 (x2), 2.5 (x2), 3.0, 3.5, 4.0, 4.5, 5.0, 5.5, 6.0, 6.5, 7.0, 7.5, 8.0, 8.5, 9.0, 10.0, 10.5, 11.0, 12.0, 13.0

Item ID: **TTDB28**

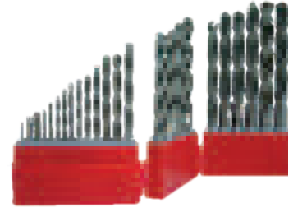

34
Pieces

DRILL BIT SET 1.0-13.0 MM 34 PIECES

- Standard drill bits for use in steel and cast iron, etc
- Spiral angle of 28° to expel swarf etc
- Point angle of 118° and a split point for better positional accuracy
- Designed and manufactured to DIN338

Fully Ground Drill Bits:

1.0(x4), 1.5(x3), 2.0(x2), 2.5, 3.0, 3.3, 3.5, 4.0, 4.2, 4.5, 5.0, 5.5, 6.0, 6.5, 6.8, 7.0, 7.5, 8.0, 8.5, 9.0, 9.5, 10.0, 10.5, 11.0, 11.5, 12.0, 12.5, 13.0

Item ID: **DB034**

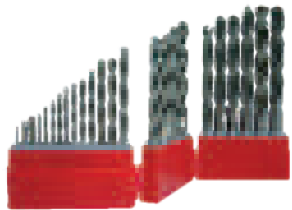

28
Pieces

DRILL BIT SET 1.0-10.0 MM 28 PIECES

- Standard drill bits for use in steel and cast iron, etc
- Spiral angle of 28° to expel swarf etc
- Point angle of 118° and a split point for better positional accuracy
- Designed and manufactured to DIN338

Fully Ground Drill Bits:

1.0(x4), 1.5(x3), 2.0(x2), 2.5, 3.0, 3.3, 3.5, 4.0, 4.2, 4.5, 5.0, 5.5, 6.0, 6.5, 6.8, 7.0, 7.5, 8.0, 8.5, 9.0, 9.5, 10.0

Item ID: **DB028**



TAPS

- Suitable for repairing damaged threads
- Made from SK5 carbon steel
- Hardness 58 ±5

ITEM ID:	Size	Description
TDT03050	M3 x 0.5	Spare Tap
TDT04070	M4 x 0.7	Spare Tap
TDT05080	M5 x 0.8	Spare Tap
TDT06100	M6 x 1.0	Spare Tap
TDT08125	M8 x 1.25	Spare Tap
TDT10150	M10 x 1.5	Spare Tap
TDT12175	M12 x 1.75	Spare Tap



TAP HANDLE

- Individual tap handle for use with TengTools rethreading taps
- Also suitable for use with TengTools screw extractors (SE05 and TMSE05S)
- Suitable for M3 to M12 tap sizes

Item ID: **TAP-HNDL**



1/4" TAP CHUCK

- Suitable for use with TengTools taps
- Use with a 1/4" drive ratchet
- Satin finish with a knurled grip for a better grip when handling

ITEM ID:	Drive	For Taps	Chuck Diameter
M140071	1/4"	3-8	20
M140072	1/4"	5-12	25

REPAIR KIT ADJUSTABLE TAP CHUCK

- Service kit for repairing tap chucks

ITEM ID:	Suitable For
M140071RK	M140071
M140072RK	M140072



DIES

- Suitable for repairing damaged threads
- Made from SK5 carbon steel
- Hardness 58 ±5

ITEM ID:	Size	Description
TDD03050	M3 x 0.5	Spare Die
TDD04070	M4 x 0.7	Spare Die
TDD05080	M5 x 0.8	Spare Die
TDD06100	M6 x 1.0	Spare Die
TDD08125	M8 x 1.25	Spare Die
TDD10150	M10 x 1.5	Spare Die
TDD12175	M12 x 1.75	Spare Die



DIE HANDLE

- Individual die handle for use with TengTools rethreading dies
- Suitable for M3 to M12 die sizes

Item ID: **DIE-HNDL**



1/4" DIE CHUCK

- Suitable for use with TengTools M3 to M12 dies
- Use with a 1/4" drive ratchet
- Satin finish for a better grip when handling

Item ID: **M140070**



TT
SERIES
1

17
Pieces

TAP AND DIE SET TTI 17 PIECES

- Suitable for repairing damaged threads from M3 to M12
- Tap and die holders included
- A thread gauge is included to help identify the pitch of the thread

Metric dies:
3x0.5 mm, 4x0.7 mm, 5x0.8 mm, 6x1.0 mm, 8x1.25 mm, 10x1.5 mm, 12x1.75 mm
Metric taps:
3mm, 4mm, 5mm, 6mm, 8mm, 10mm, 12mm
Accessories:
Tap handle (capacity 3 to 12mm), die handle with adjustment screw (capacity 3 to 12mm), screw pitch gauge

Item ID: **TTTD17**

NEW

TT
SERIES



Store x4 of these sets in a TCI Tray

5
Pieces

SCREW EXTRACTOR SET 5 PIECES

- Tapered design for removing damaged screws
- Suitable for both clockwise and anti-clockwise threads
- Square shank and manufactured in CR-V 6150 steel hardened to HRC50-52
- Use with drill sizes 3, 4, 5, 7 and 9mm
- Use with the TengTools tap handle (TAP-HDL)
- Supplied in the unique TengTools TJ tray
- Clear fold up lid to see which set you need to use
- Sliding catch to secure the set when not in use
- Box equipped with a belt clip to keep tools in easy reach

Item ID: **TJSE05S**



TT
SERIES
2

34
Pieces

TAP AND DIE SET TT2 34 PIECES

- Designed for the repair of damaged threads covering M3 to M12
- Includes taps and dies with interchangeable chucks
- Screw extractors also included to give a complete set for repairing threads
- Various accessories including drill bits, a screw pitch gauge and mini palm ratchet

Metric dies:
3x0.5 mm, 4x0.7 mm, 5x0.8 mm, 6x1.0 mm, 8x1.25 mm, 10x1.5 mm, 12x1.75 mm
Metric taps:
3mm, 4mm, 5mm, 6mm, 8mm, 10mm, 12mm
Fully ground drill bits:
2.5, 3.3, 4.2, 5.0, 6.8, 8.5, 10.5 mm
Screw extractors:
1/8", 3/16", 15/64", 5/16", 3/8"
Accessories:
Screw pitch gauge, mini screwdriver hex (2.5x40mm), 1/4" extension bar, 3/8"F:1/4"M adaptor, 1/4" mini palm ratchet, 1/4" interchangeable die chuck, 1/4" tap chuck (x2 - M3-M8, M5-M12)

Item ID: **TTTD34**



NEEDLE FILE HAND

- 160mm long with a plastic handle for use with more detailed work
- Hand file type

Item ID: **TTNF12-01**



NEEDLE FILE KNIFE TYPE

- 160mm long with a plastic handle for use with more detailed work
- Needle knife file type

Item ID: **TTNF12-07**



NEEDLE FILE HALF ROUND

- 160mm long with a plastic handle for use with more detailed work
- Half round file type

Item ID: **TTNF12-02**



NEEDLE FILE BARRETTE

- 160mm long with a plastic handle for use with more detailed work
- Barrette file type

Item ID: **TTNF12-08**



NEEDLE FILE THREE SQUARE

- 160mm long with a plastic handle for use with more detailed work
- Three square triangular file type

Item ID: **TTNF12-03**



NEEDLE FILE CROSSING

- 160mm long with a plastic handle for use with more detailed work
- Crossing file type

Item ID: **TTNF12-09**



NEEDLE FILE SQUARE

- 160mm long with a plastic handle for use with more detailed work
- Square file type

Item ID: **TTNF12-04**



NEEDLE FILE OVAL

- 160mm long with a plastic handle for use with more detailed work
- Oval file type

Item ID: **TTNF12-10**



NEEDLE FILE ROUND

- 160mm long with a plastic handle for use with more detailed work
- Round file type

Item ID: **TTNF12-05**



NEEDLE FILE FEATHER EDGE

- 160mm long with a plastic handle for use with more detailed work
- Feather edge file type

Item ID: **TTNF12-11**



NEEDLE FILE FLAT POINT

- 160mm long with a plastic handle for use with more detailed work
- Flat point file type

Item ID: **TTNF12-06**



NEEDLE FILE ROUND EDGE

- 160mm long with a plastic handle for use with more detailed work
- Round edge file type

Item ID: **TTNF12-12**



TT SERIES

12 Pieces

NEEDLE FILE SET TTI 12 PIECES

- All the most commonly used types of needle file in one handy set
- Removable lid and dove tail joints

Needle Files:

Hand, half round, three square, square, round, flat point, knife type, barrette, crossing, oval, feather edge, round edge flat

Item ID: **TTNF12**



HAND FILE - FLAT

- 10" hand file
- High carbon steel for durability and strength
- Bi-material handle for a more comfortable grip
- 2nd cut to create a diamond pattern cutting surface for smoother filing
- Cut on both edges for filing grooves, etc

Item ID: **FLFT10**



HAND FILE - FLAT

- 10" hand file
- High carbon steel for durability and strength
- Bi-material handle for a more comfortable grip
- 2nd cut to create a diamond pattern cutting surface for smoother filing
- Cut on both edges for filing grooves, etc

Item ID: **FLHF10**



HAND FILE - HALF ROUND

- 10" hand file
- High carbon steel for durability and strength
- Bi-material handle for a more comfortable grip
- 2nd cut to create a diamond pattern cutting surface for smoother filing

Item ID: **FLHR10**



HAND FILE - ROUND

- 10" hand file
- High carbon steel for durability and strength
- Bi-material handle for a more comfortable grip
- 2nd cut to create a diamond pattern cutting surface for smoother filing

Item ID: **FLRD10**



HAND FILE - TRIANGULAR

- 10" hand file
- High carbon steel for durability and strength
- Bi-material handle for a more comfortable grip
- 2nd cut to create a diamond pattern cutting surface for smoother filing

Item ID: **FLTR10**



HAND FILE - SQUARE

- 10" hand file
- High carbon steel for durability and strength
- Bi-material handle for a more comfortable grip
- 2nd cut to create a diamond pattern cutting surface for smoother filing

Item ID: **FLSQ10**



TT SERIES

x4

5 Pieces

HAND FILE SET TTX4 5 PIECES

- 10" high carbon steel hand files
- Bi-material handle for a more comfortable grip
- 2nd cut to create a diamond pattern cutting surface for smoother filing
- Cut on both edges of the flat files for filing grooves, etc

10" Files:

Flat, Hand, Half Round, Round, Three square

Item ID: **TTXF05**



5 Pieces

HAND FILE SET WALL RACK 5 PIECES

- 10" high carbon steel hand files
- Bi-material handle for a more comfortable grip
- 2nd cut to create a diamond pattern cutting surface for smoother filing
- Cut on both edges of the flat files for filing grooves, etc
- Supplied with a wall rack for fixing to the wall or a workbench

10" Files:

Flat, Hand, Half Round, Round, Three square

Item ID: **WRFL05**

MEASURING TOOLS

ACCURACY IS KEY

Our range of Measuring Tools have been developed by focusing on TengTools users requirements across the automotive & industrial sectors. All tools are available individually but are also available in the unique TengTools TT trays so you can add them to your existing tool kit or include them when you are building your ultimate tool kit.



Wide range of tools
now available including
calipers & micrometers





MICROMETER

- Friction thimble and locking nut for easy operation
- Forged frame with hardened steel and polished measuring surfaces
- Matt chrome plated scale for easy reading
- Supplied with a plastic storage case
- Designed and manufactured to DIN863

Specifications:		
Measuring range	mm	0-25
Reading	mm	0.01
Precision	mm	0.004

Item ID: **MIR25**



VERNIER CALIPER

- 4 function caliper to measure height, width, depth and step
- Metric and inch scales with 0.05mm and 1/128" scales
- Frosted chrome plated scale for easier reading
- Stainless steel construction with lapped edges
- Supplied with a plastic storage case
- Designed and manufactured to DIN862

Specifications:		
Length of measurement	mm	150
Jaw length	mm	40

Item ID: **CALV150**



DIGITAL CALIPER

- 4 function caliper to measure height, width, depth and step
- Adjustable between mm and inches
- Reset button and zero set in any position
- Automatic switch off to conserve batteries
- 0.01mm reading scale with 8mm high figures
- Uses CR2032 batteries (supplied)
- Supplied with a plastic storage case
- Designed and manufactured to DIN862

Specifications:		
Length of measurement	mm	150
Jaw length	mm	40
Height of figures	mm	8
Resolution	mm	0.01
Accuracy	mm	±0.02

Item ID: **CALD150**



FEELER GAUGE

- Blades for measuring from 0.05mm to 1.0mm
- Hardened rolled steel for durability and accuracy
- Fold up case with tightening screw for easy storage
- Manufactured according to Din 2275/T2 standard

ITEM ID:	No. of Blades	Blade Length	
		mm	
FG13100	13	100	
FG20100	20	100	
FG20200	20	200	



THREAD GAUGE MM/UNC 54 BLADES

- 54 blades in a handy holder with tightening screws
- Thread gauge 60°
- Suitable for measuring metric and UNC threads
- Manufactured from #45 steel for a long lasting gauge

Metric thread gauges:	
0.25, 0.3, 0.35, 0.4, 0.45, 0.5, 0.6, 0.7, 0.75, 0.8, 0.9, 1.0, 1.25, 1.5, 1.75, 2.0, 2.5, 3.0, 3.5, 4.0, 4.5, 5.0, 5.5, 6.0	
UNC thread gauges:	
4, 4 1/2, 5, 5 1/2, 6, 7, 8, 9, 10, 11, 11 1/2, 12, 13, 14, 15, 16, 18, 20, 22, 24, 26, 27, 28, 30, 32, 34, 36, 38, 40, 42	

Item ID: **TGMMUNC**



STEEL RULES

- Stainless steel to avoid corrosion
- Hanging hole for easy storage

ITEM ID:	Length mm	Width x Thickness		Scale
		mm		
STMM150	150	20 x 0.8	mm / AF	
ST200	200	20 x 0.8	mm / AF	



DIAL GAUGE WITH MAGNETIC STAND

- Aluminium dial indicator
- 57mm diameter dial with a turnable scale and two tolerance indexes
- An extra pointer indicates whole millimetres to make measurements simple
- The stand has central locking
- A strong magnet in the base to hold the stand in place when in use

Specifications:		
Dial Indicator	10mm/0.01mm	
Magnetic Force	Kg	80
Measuring range	mm	0-10
Reading	mm	0.01
Maximum height	mm	330
Base plate length	mm	55
Base plate width	mm	50
Base plate height	mm	60
Weight	kg	1.625

Item ID: **DGMM**



SQUARE BASE

- Zinc plated for corrosion resistance
- Base square design enables the square to be sat on a work surface

ITEM ID:	Length mm	Blade Length mm
SQAB10070	100	70
SQAB150100	150	100
SQAB200130	200	130
SQAB300175	300	175



MEASURING TOOL SET TT2 4 PIECES

- Ideal for mechanics and technicians
- Includes a 4 function digital caliper, multimeter, thread gauge and feeler gauge sets

Measuring Tools:	
Digital Caliper	150mm / 6"
Thread Gauge Set	0.25-6.0mm, 4-42 UNC
Feeler Gauge Set	100mm Length, 0.05-1.0mm
Multimeter	AC, DC, voltage, current, resistance, temperature, CAT II 250V

Item ID: **TTDCM**

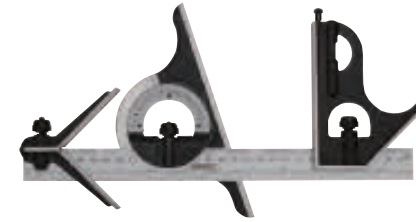

COMBINATION SQUARE

- For measuring and checking angles
- Graduated in mm and inches for universal use
- 300mm steel rule with a reversible protractor, adjustable angle ledge and centre head
- Angle ledge and protractor both include a spirit level

Specifications:		
Protractor reading		0-180°
Steel rule length	mm	300
Square head length	mm	110
Centre head length	mm	63

Item ID: **SQAC300**



ALUMINIUM STOCK TRY SQUARES

- Stainless steel blade with an anodised aluminium stock
- Blade measures 1.5 x 45mm with the stock being 18mm wide
- Milled working surface with deep etched markings
- Highly resistant to wear

ITEM ID:	Blade Length mm	Accuracy	Weight g
SQAA200	200	±0.03	240
SQAA250	250	±0.03	275
SQAA300	100	±0.03	300



PLASTIC STOCK TRY SQUARES

- Stainless steel blade with a fibre glass framed plastic stock
- Blade measures 1.0 x 45mm with the stock being 18mm wide
- Milled working surface with deep etched markings
- Highly resistant to wear

ITEM ID:	Blade Length mm	Accuracy	Weight g
SQAP250	250	±0.06	150
SQAP300	300	±0.06	160



SLIDING BEVEL

- Check edges for consistency by sliding the edge over the material
- Duplicate angles for marking by setting the adjustable blade
- Straight and true stainless steel blade for accuracy
- Plastic stock for reduced weight and a better grip

ITEM ID:	Blade Length mm	Width mm	Accuracy	Weight g
AB200	200	25	25	100



MEASURING TOOL SET TT1 4 PIECES

- Ideal for engineers and technicians
- Includes a 4 function vernier caliper, steel rule, scribe and base square

Measuring Tools:	
Vernier Caliper	150mm / 6"
Steel Rule	150 mm
Base Square	100 x 70 mm
Scriber	150 mm

Item ID: **TTBM**



MEASURING TOOL SET FOAM2 3 PIECES

- Ideal for machinists and technicians
- Includes a digital 4 function caliper, micrometer and a dial indicator complete with a magnetic stand
- Tools are held in place using three colour pre-cut EVA foam

Measuring Tools:	
Digital Caliper	150mm / 6"
Micrometer	0-25mm
Dial Indicator with Stand	0-10mm measuring range
Magnetic Stand with Central Locking	

Item ID: **TEDIMM**





MEASURING TAPE METRIC/INCH

- mm and inches for international use
- ABS case for durability
- Rubberised grip for a more secure grip especially when wet or oily
- Tape lock and belt clip for secure storage when being used
- Power return tape for automatic rewinding
- Aligning hook for internal/external measurements
- Designed and manufactured to Cat II

ITEM ID:	Length m	Length ft	Width mm
MT03	3	10	13
MT05	5	16	19
MT08	8	26	25



MEASURING TAPE CLOSED CASE

- mm and inches for international use
- High impact plastic case for durability
- Rubberised grip for a more secure grip especially when wet or oily
- Tape lock and belt clip for secure storage when being used
- Steel roller cage prevents damage to the case
- Aligning hook for internal/external measurements
- Designed and manufactured to Cat II

ITEM ID:	Length m	Width mm
MT10	10	10
MT15	15	10
MT30	30	10



MEASURING TAPE METRIC

- Graduated in mm only
- ABS case for durability
- Rubberised grip for a more secure grip especially when wet or oily
- Tape lock and belt clip for secure storage when being used
- Power return tape for automatic rewinding
- Aligning hook for internal/external measurements
- Designed and manufactured to Cat II

ITEM ID:	Length m	Width mm
MT03MM	3	13
MT05MM	5	19
MT08MM	8	25



MEASURING TAPE OPEN HANDLE

- mm and inches for international use
- High impact plastic case for durability
- Rubberised grip for a more secure grip especially when wet or oily
- Tape lock for secure storage when being used
- Steel roller cage prevents damage to the case when the nylon tape is retracted
- Designed and manufactured to Cat II

ITEM ID:	Length m	Width mm
MTS30	30	12.7
MTS50	50	12.7



TORPEDO SPIRIT LEVEL

- Magnetic aluminium "torpedo" spirit level
- 3 magnets on the underside help fix the level to ferrous work pieces
- One horizontal, one vertical and one 45° angled vials
- Crush proof, durable vials with high transparency for easy reading
- Highly resistant to ultra violet light and fluctuations in temperature
- Shock absorbent end protectors to reduce the risk of damage
- Temperature proof vial mountings to reduce the risk of distortion

ITEM ID:	Material	Length mm	Width mm	Height mm	Tolerance Normal	Weight g
SLT01	Aluminium	230	16	38	±1.0mm/m	190
SLT02	ABS Plastic	230	16	40	±1.5mm/m	160



ALUMINIUM SPIRIT LEVEL

- 400mm long
- One horizontal and two vertical vials (90° and 45°)
- The vials are designed for easy, all round reading
- Impact resistant end caps to reduce the risk of damage
- Measurement accuracy of 1.0mm per meter

Item ID: SLA040



ALUMINIUM SPIRIT LEVEL

- Crush proof, durable vials with high transparency for easy reading
- Highly resistant to ultra violet light and fluctuations in temperature
- Shock absorbent end protectors to reduce the risk of damage
- Temperature proof vial mountings to reduce the risk of distortion

ITEM ID:	Length mm	Width mm	Height mm	Tolerance Normal	Tolerance Inverted	Weight g
SLA0300	300	24	50	±0.5mm/m	±0.75mm/m	210
SLA0400	400	24	50	±0.5mm/m	±0.75mm/m	280
SLA0600	600	24	50	±0.5mm/m	±0.75mm/m	420
SLA1000	1000	24	50	±0.5mm/m	±0.75mm/m	690
SLA1200	1200	24	50	±0.5mm/m	±0.75mm/m	840
SLA1500	1500	24	50	±0.5mm/m	±0.75mm/m	1050
SLA1800	1800	24	50	±0.5mm/m	±0.75mm/m	1260



MAGNETIC ALUMINIUM SPIRIT LEVEL

- Magnets on the underside help fix the level to ferrous work pieces
- Crush proof, durable vials with high transparency for easy reading
- Highly resistant to ultra violet light and fluctuations in temperature
- Shock absorbent end protectors to reduce the risk of damage
- Temperature proof vial mountings to reduce the risk of distortion

ITEM ID:	Length mm	Width mm	Height mm	Tolerance Normal	Tolerance Inverted	Weight g
SLM0300	300	24	50	±0.75mm/m	±0.75mm/m	240
SLM0400	400	24	50	±0.75mm/m	±0.75mm/m	310
SLM0600	600	24	50	±0.75mm/m	±0.75mm/m	450
SLM1000	1000	24	50	±0.75mm/m	±0.75mm/m	750
SLM1200	1200	24	50	±0.75mm/m	±0.75mm/m	900

AUTO TOOLS

ESSENTIALS FOR ANY GARAGE

When working on motors and general servicing it is vital that you have the right tools ready when you are. Whether it is a spark plug socket or hose clamps you need tools that are great to work with and bring better results.



90° HOOK TOOL

- Hook tool with a 90° bent hook
- Ideal for retrieving lost or dropped items
- Ergonomically designed bi-material handle for easy use
- Hole in the handle for hanging or for use with a fall protection wire

Item ID: MDH-S



GASKET SCRAPER

- 22mm blade for the easy removal of gasket residue
- Ergonomically designed bi-material handle for easy use
- Hole in the handle for hanging or for use with a fall protection wire

Item ID: MD-SCR



HOOK TOOL

- Hook tool with an S shaped bent hook
- Ideal for retrieving lost or dropped items
- Ergonomically designed bi-material handle for easy use
- Hole in the handle for hanging or for use with a fall protection wire

Item ID: MDH-L



AWL STRAIGHT BI-MATERIAL GRIP

- Straight awl with a round tip
- Ideal for piercing materials or for creating a start hole for screws
- Ergonomically designed bi-material handle for easy use
- Hole in the handle for hanging or for use with a fall protection wire
- Length: 164mm

Item ID: MDA180



AWL ROUND TIP

- Straight awl with a round tip
- Ideal for piercing materials or for creating a start hole for screws
- Ergonomically designed bi-material handle for easy use
- Hole in the handle for hanging or for use with a fall protection wire

Item ID: MDA-R



90° HOOK TOOL BI-MATERIAL GRIP

- Hook tool with a 90° bent hook
- Ideal for retrieving lost or dropped items
- Ergonomically designed bi-material handle for easy use
- Hole in the handle for hanging or for use with a fall protection wire
- Length: 164mm

Item ID: MDP90



AWL SQUARE TIP

- Straight awl with a square tip
- Ideal for piercing materials or for creating a start hole for screws
- Ergonomically designed bi-material handle for easy use
- Hole in the handle for hanging or for use with a fall protection wire

Item ID: MDA-SQ





35° HOOK TOOL BI-MATERIAL GRIP

- Hook tool with a 35° bent point
- Ideal for retrieving lost or dropped items
- Ergonomically designed bi-material handle for easy use
- Hole in the handle for hanging or for use with a fall protection wire
- Length: 164mm

Item ID: **MDP35**



125° HOOK TOOL BI-MATERIAL GRIP

- Hook tool with a 125° bent hook
- Ideal for retrieving lost or dropped items
- Ergonomically designed bi-material handle for easy use
- Hole in the handle for hanging or for use with a fall protection wire
- Length: 164mm

Item ID: **MDP125**



TT SERIES

1

HOOK & PICK SET TT1 4 PIECES

- 4 piece hook and pick set
- Includes hooks, awls and picks for detail work and scribing
- Ideal for cleaning components and retrieving lost items in hard to reach places

Hooks & Picks:

Straight Awl, 35° Hook tool, 90° Hook Tool, 125° Hook Tool

Item ID: **TTMDP**



TT SERIES

1

SCRAPER SET TTI 4 PIECES

- Includes a gasket scraper, an awl and two hook tools
- Ideal for cleaning, scraping and removing unwanted residue

Scrapers:

Gasket scraper 22mm wide blade, total length 245mm

Hooks & awl Curved hook, 90° hook and awl

Item ID: **TTSR04**

NEW

TT SERIES

1

Store x4 of these sets in a TCI Tray



4 Pieces

4 PIECE HOOK AND PICK SET

- Interchangeable hooks and picks with a aluminium handle
- The handle has a built in magnet for retrieving lost ferrous parts
- Includes an awl as well as 3 different hooks with 45° and 90° tips
- Supplied in the unique TengTools TJ tray
- Clear fold up lid to see which set you need to use
- Sliding catch to secure the set when not in use

Item ID: **TJ149**



HOSE CLIP DRIVER 6MM/7MM

- Interchangeable double ended socket to give two tools in one
- Fits most commonly used worm drive hose clips such as Jubilee® hose clips
- Flexible shaft for easier access in confined spaces
- Overall length 275mm

ITEM ID:	Description
MD503N	Hose clip driver
MD503RK	Replacement 6/7mm socket



HOSE CLIP DRIVER 7MM

- Fits most commonly used worm drive hose clips such as Jubilee® hose clips
- Flexible shaft for easier access in confined spaces
- Overall length 275mm

Item ID: **MD503NA**



HOSE CLIP DRIVER 8MM

- Fits European style worm drive hose clips and Jubilee® high torque hose clips
- Flexible shaft for easier access in confined spaces
- Overall length 275mm

Item ID: **MD503ND**



HOSE CLAMP

- Specially designed jaws prevent internal hoses from damage when clamping
- Light weight
- Easy to use
- Non conductive

ITEM ID:	Capacity mm	Capacity AF
AT080	6 to 19	¼" to ¾"
AT085	6 to 32	¼" to 1-½"
AT090	19 to 57	¾" to 2-½"



TT SERIES

1

3 Pieces

HOSE CLAMP SET TT1 3 PIECES

- Range of sizes giving a capacity of 6 to 57mm (¼" to 2 ¼")
- Specially designed jaws prevent internal hoses from damage when clamping
- Lightweight and easy to use
- Non conductive

Hose clamps:

For hoses: 1/4"-3/4", 1/4"-1-1/4", 3/4"-2-1/4"

Item ID: **TTHC03**



SPARK PLUG BOOT PLIER

- Designed to pull the spark plug boot from the spark plug without disturbing the HT lead
- Spring action for easier use particularly in confined spaces
- Plastic grip on the handle and the gripping area

ITEM ID:	Length mm	Weight g
SPBP20	250	297



SPARK PLUG SOCKETS

- Chrome vanadium
- Rubber insert holds the spark plug in place to prevent it dropping
- Satin finish for a better grip when handling the socket
- 6 point single hexagon socket for a better grip
- Ball bearing recess on the female end to grip the ratchet
- Supplied with a metal socket clip for use with a socket rail

ITEM ID:	Drive	Size	Width mm	Length mm	Thread Size	Weight g
M380039-C	3/8"	14mm	20	64	8	73
M380040-C	3/8"	16mm	21.4	64	10	100
M380041-C	3/8"	16mm Flexible	22	85	10	117
M380042-C	3/8"	18mm	23.5	70	12	130
M380046-C	3/8"	21mm	28	70	14	160
M380047-C	3/8"	21mm Flexible	28	91	14	169
M120040-C	1/2"	16mm	21.4	70	10	165
M120042-C	1/2"	18mm	24.2	70	12	165
M120046-C	1/2"	21mm	28	70	14	165



TT SERIES
x4

5 Pieces 3/8" mm

3/8" T BAR SPARK PLUG SOCKET SET TTX4

- Magnet spark plug sockets
- 3/8" drive extra long swivelling magnetic spark plug sockets for use in hard to reach places
- T bar with the TengTools T-HD handle for more comfortable use

2 Piece T-bar handle
3/8" Drive extra long swivelling spark plug sockets:
mm: 14 16 21

Item ID: **TTXTB05**



FOAM SERIES
x4

5 Pieces 3/8" mm

3/8" T BAR SPARK PLUG SOCKET SET FOAMX4

- Extra long swivelling magnetic spark plug sockets for use in hard to reach places
- T bar with the TengTools T-HD handle for more comfortable use

2 Piece T-bar handle
3/8" Drive extra long swivelling spark plug sockets:
mm: 14 16 21

Item ID: **TEXTB05**

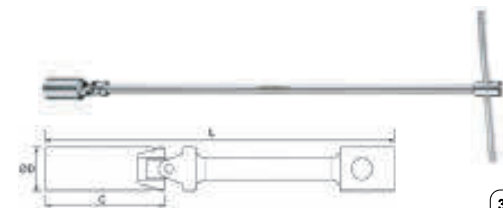

3/8"

3/8" T-BAR SPARK PLUG SOCKET

- Extra long swivelling spark plug socket
- Long reach bar ideal for use in hard to reach places
- Universal joint and magnet at the socket
- Includes a T bar for fast pre-tightening and additional torque

ITEM ID:	Drive	Size mm	D mm	C mm	L mm	Weight g
TBUSP14	3/8"	14	18.8	60	520	380
TBUSP16	3/8"	16	21.8	60	520	400
TBUSP21	3/8"	21	27.8	60	520	440
T-HD01	200mm x 8mm spare bar for use with T-bar spark plug sockets					



SPARK PLUG THREAD CLEANER

- Cleaning tool for spark plug threads in engine blocks

ITEM ID:	For Threads mm
TRC1012	10 x 1 & 12 x 1.25
TRC1418	14 x 1.25 & 18 x 1.5



OIL FILTER REMOVAL TOOL STRAP TYPE

- Fully adjustable heavy duty strap
- Suitable for workshop tasks where round items need to be gripped
- Strong, drop forged steel handle for high leverage
- Reinforced, rubberised non stretch strap for a good grip
- Grips oil filters, etc up to 160mm diameter
- Overall length 230mm

ITEM ID:	Description
9123	Oil filter wrench
9123RK	Replacement Strap



OIL FILTER REMOVAL PLIER

- 53-118mm capacity to suit most oil filters
- Two stage grip areas on the jaws for added versatility
- Ideal for removing and installing objects of many shapes when a tight grip is required
- Chrome vanadium with drop forged jaws, heat treated and nickel plated

Item ID: **409**



1/2"

1/2" OIL FILTER REMOVAL TOOL STRAP TYPE

- Nylon webbing strap for gripping oil filters without causing damage
- 1/2" drive carbon steel adaptor for use with a ratchet or flex handle
- Grips oil filters up to 130mm diameter

ITEM ID:	Description	Drive	Capacity mm
9110	Oil filter wrench	1/2"	130
9110RK-1	Replacement Strap		

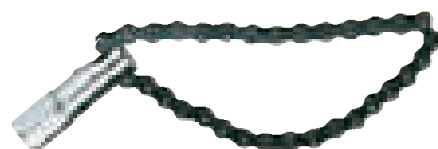

1/2"

1/2" OIL FILTER REMOVAL TOOL CHAIN TYPE

- Chain for gripping oil filters even when oily or damaged
- 1/2" drive carbon steel adaptor for use with a ratchet or flex handle
- Grips oil filters up to 120mm diameter

ITEM ID:	Description	Drive	Capacity mm
9120	Oil filter wrench	1/2"	120
9120RK-1	Replacement Chain		



1/2"

1/2" HEAVY DUTY OIL FILTER REMOVAL TOOL

- Maximum tensile strength of 1,850 kgf for the most stubborn of oil filters
- Chain for gripping oil filters even when oily or damaged
- 1/2" drive adaptor for use with a ratchet or 24mm spanner
- Grips oil filters up to 150mm diameter

Item ID: **9120HD**



TT SERIES

16 Pieces 3/8"

OIL SERVICE SET TTI 16 PIECES

- All the tools normally required for an oil service included in one handy set
- Includes an oil filter wrench, drain plug set, spark plug sockets, metric feeler gauge set and a 3 in 1 inspection tool with magnetic pick up

3/8" Drive Accessories:
3" & 10" wobble extensions, 1/2" F x 3/8" Male T-bar adaptor
3/8" Drive Sockets:
21mm regular 6 point socket, 16 & 21mm spark plug sockets
Drain Plug Set:
Bar, 5/16" hex x 3/8" hex, 11mm square x 12mm hex, 17mm hex x 1/2" hex, 8mm square x 3/8" square, 13mm square x 14mm hex, 8mm hex x 10mm hex
Service Tools:
Strap type oil filter wrench, 3 in 1 telescopic inspection tool, 20 piece feeler gauge set (0.05 mm - 1.0 mm)

Item ID: **TTOS16**



DRAIN PLUG

- Double ended design to give 2 tools in 1
- For drain plugs on engines and gear boxes
- Use with a T bar or a 21mm socket or wrench

ITEM ID:	Size
DP0810	8mm hex x 10mm hex
DP0812	8mm square x 3/8" square
DP1012	5/16" hex x 3/8" hex
DP1112	11mm square x 12mm hex
DP1314	13mm square x 14mm hex
DP1716	17mm hex x 1/2" hex



PISTON RING COMPRESSOR

- Designed for holding piston rings in place when removing or replacing pistons
- 4 tightening bands suitable for cylinder diameters from 90 to 175mm
- Self locking ratchet pawl prevents premature release and allows a positive locking action
- Friction proof band edge gives a smooth and accurate action

Item ID: **AT020**



ADJUSTABLE ENGINE CYLINDER HONING TOOL

- Adjustable to enable use on cylinders between 50 and 180mm diameter
- Spring tension adjustment to give a positive cutting action
- Suitable for use with air tools
- Supplied with 280 grit stones 100x10x8mm

ITEM ID:	Description
ATO40	Engine cylinder honing tool
ATO40-SM	Replacement 280 grit stones (3 Pieces) 100x10x8mm



ADJUSTABLE BRAKE CYLINDER HONING TOOL

- Adjustable to enable use on cylinders between 20 and 68mm diameter
- Spring tension adjustment to give a positive cutting action
- Suitable for use with air tools
- Supplied with 220 grit stones 28.5x5x2mm

ITEM ID:	Description
AT180	Brake cylinder honing tool
AT180-S	Replacement 220 grit stones (3 Pieces) 28.5x5x2mm



BRAKE SPRING WASHER TOOL

- Fits both large and small brake spring washers
- Easy to use
- Enables good visibility when assembling or dismantling brake assemblies
- Length 230mm, Weight 153g

Item ID: **AT160**



BRAKE PIN PUNCH

- 5.5mm parallel pin punch for removing pins from brake disc pads
- Overall length 165mm to clear most pin holes

Item ID: **AT170**

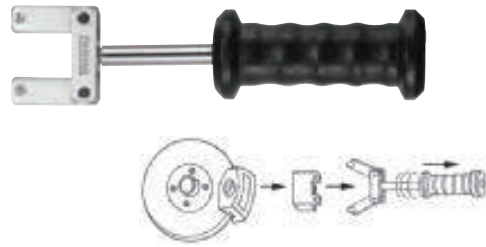

BRAKE DISC PAD PULLER

- Sliding hammer function to help release brake pads from calipers
- Simply hook on to the disc pad with 5mm pins

Item ID: **AT330**



BALL JOINT SEPERATOR

- Simple to use tool for separating ball joints

ITEM ID:	Opening mm	Adjustable Height mm
AT191	29	60
AT192	40	80
AT194	46	100



TT
SERIES

1

10
Pieces

FLARING TOOL SET TTI 10 PIECES

- Suitable for copper, brass and thin walled aluminium tubing
- 45° tube press flare pipes from 3/16" to 5/8" (4 to 14mm) diameter
- Heavy duty pipe cutter included for cutting pipes up to 32mm (1-1/4") diameter

2 piece double flaring tool set	
Pipe Cutter:	3-32 mm (1/8"-1-1/4")
Adaptors:	4, 4.75 (3/16"), 6 (1/4"), 8 (5/16"), 10, 12, 14 mm

Item ID: **TTTF10**



BALL JOINT SEPERATOR 16MM

- Simple to use tool for separating ball joints
- Heat treated drop forged steel body and thrust bolt

ITEM ID:	Opening mm	Adjustable Height mm
AT195	16	50



SPECIALIST AUTOMOTIVE SOCKETS

ITEM ID:	Drive	Size	Length mm	Application	List Price
920242	1/2"	1-5/16"	78	Wheel nuts	
920248	1/2"	1-1/2"	78	Ball Joints	
920624N	1/2"	24mm	78	Oil pressure switch	
920627N	1/2"	27mm	78	Injectors	
920628N	1/2"	28mm	78	Diesel Injectors	
920629N	1/2"	29mm	78	Thermostat switch	
920630N	1/2"	30mm	78	Hub nuts	
920632N	1/2"	32mm	78	Hub nuts/drive shafts	
920635N	1/2"	35mm	78	Hub nuts	
920636N	1/2"	36mm	78	Hub nuts	
940641-C	3/4"	41mm	58	Hub nuts	
940258	3/4"	1-13/16"	58	Deep ball joint socket	
120955-C	1/2"	TX55	100	Cylinder head bolts	
AT350	1/2"	29mm	90	Oxygen sensor socket	
AT355	3/8"	22mm	90	Oxygen sensor socket	
AT360	1/2"	27mm	85	Injector socket	
AT365	3/8"	7/8"	80	Vacuum switch socket	
AT370	3/8"	11/16"	74	Oil sender socket	
AT375	1/2"	7/8"	50	Heated oxygen sensor socket	
AT380	3/8"	7/8"	30	Offset Oxygen sensor socket	



TT
SERIES

1

7
Pieces

3/8"

1/2"

AUTOMOTIVE SOCKET SET TTI 7 PIECES

- All the most commonly used specialist automotive sockets in one handy set
- Includes sockets for removing and installing injectors, oil sender and vacuum switches as well as various oxygen sensors

3/8" Drive Sockets:		
22 mm	Length: 90 mm	Oxygen sensor socket for Mitsubishi, Nissan, Opel, Vauxhall & VW
7/8"	Length: 80 mm	Vacuum switch socket
1-11/16"	Length: 74 mm	Oil sender socket
7/8"	Length: 30 mm	Offset oxygen sensor socket
1/2" Drive Sockets:		
29 mm	Length: 90 mm	Oxygen sensor socket for GM
27 mm	Length: 85 mm	Injector socket for M24
7/8"	Length: 50 mm	Heated oxygen sensor socket

Item ID: **TTSS07**



TYRE LEVER

- Traditional flat design for easy use
- Manufactured in medium carbon steel (HRC40 +/-2%) for high leverage

ITEM ID:	Size mm	Size AF
AT20512	304	12
AT20516	406	16
AT20520	508	20
AT20524	609	24



1/2"

1/2" WHEEL WRENCH

- 1/2" drive telescopic wheel wrench
- Extends from 14" (35cm) to 21" (55cm) making it ideal for keeping in the car
- Chrome vanadium steel for added strength and higher torque
- Supplied with a double ended impact sockets

ITEM ID:	Drive	Size mm	Weight g
1202	1/2"	17 x 19	900
1202A	1/2"	21 x 22	905

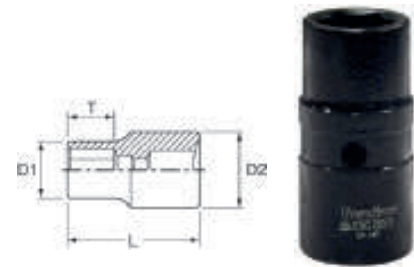

1/2" mm

1/2" DOUBLE ENDED IMPACT SOCKET METRIC

- Double ended 1/2" drive socket to give two sizes in one socket
- Chrome molybdenum for use with power tools
- Black phosphate finish for easy identification as an impact socket accessory

ITEM ID:	Size mm	L mm	D1 mm	D2 mm
9291719	17 / 19	58	26	28
9292122	21 / 22	58	30	32



3 Pieces 1/2" mm

1/2" DOUBLE ENDED IMPACT SOCKET SET

- Includes the most commonly used wheel nut socket sizes
- Chrome molybdenum for use with power tools
- Black phosphate finish for easy identification as an impact socket

3" Extension bar
Double Ended Wheel Nut Sockets:
17 x 19mm, 21 x 22mm

Item ID: 9203N1



1/2" mm

1/2" IMPACT SOCKET WHEEL NUT

- Thin wall design for reaching in to recesses
- Protective sleeve for use on alloy wheels
- DIN standard design for use with a retaining pin and ring
- Chrome molybdenum for use with power tools
- Ring and pin fixing hole on the female end to secure the socket to the air gun

ITEM ID:	Size mm	L mm	T mm	D1 mm	D2 mm	Weight g
920517N	17	85	27	26	32	260
920519N	19	85	27	29	32	270
920521N	21	85	27	29	32	380



3 Pieces 1/2" mm

1/2" IMPACT SOCKET WHEEL NUT SET

- Thin wall design for reaching in to recesses
- Protective sleeve for use on alloy wheels
- DIN standard design for use with a retaining pin and ring
- Chrome molybdenum for use with power tools
- Ring and pin fixing hole on the female end to secure the socket to the air gun

Item ID: 9203N



FOAM SERIES x4

5 Pieces 1/2" mm

WHEEL TOOL SET FOAMX4 5 PIECES

- 17" 1/2" drive flex handle for shifting stubborn wheel nuts
- A short extension bar for reaching into recessed wheel rims
- Long reach sockets with protective nylon sleeves to avoid damage to wheels
- Tools are held in place using three colour pre-cut EVA foam

1/2" Drive Accessories:
17" Flex Handle, 5" Extension bar
Impact Wheel Nut Sockets:
17, 19, 21mm

Item ID: TEXW05



11 Pieces

BICYCLE KEY SET 11 PIECES

- Designed for cyclists to carry easily
- Includes hexagon, TX and screwdriver keys together with a tyre lever and chain repair tool
- Chrome nickel finish
- Supplied in a handy fold up aluminium case

Ergonomically Designed Aluminium Holder, Tyre lever, Chain tool

Individual Keys:	
mm: 1 x 5.5	
PH2	
TX25 TX30	
mm: 4 5 6	

Item ID: 1473



WING COVER

- Full length magnetic strip to hold the cover in place on the vehicle bodywork
- Protects the paintwork from scratching when working on the vehicle
- Heavy duty red PVC with a cloth backing
- Includes the TengTools eyes logo in full colour
- Measures 40 x 107cm to provide a good area of protection

Item ID: FC01



SUCTION LIFTER SINGLE

- Single 118mm diameter suction cup
- Handles open or close to engage or release the suction cups
- Ideal for lifting of items with flat, smooth surfaces such as glass up to 30 kilos
- Can also be used to pull out dents in bodywork panels

ITEM ID:	Suction Cups	Max Load Kg	Cup Diameter mm	Weight g
SL01	1	30	118	310



SUCTION LIFTER TRIPLE

- Three 118mm diameter suction cups
- Simple levers open or close to engage or release the suction cups
- Ideal for lifting of items with flat, smooth surfaces such as glass up to 120 kilos

ITEM ID:	Suction Cups	Max Load Kg	Cup Diameter mm	Weight g
SL03	3	120	118	900



SUCTION LIFTER DOUBLE

- Two 118mm diameter suction cups
- Simple levers open or close to engage or release the suction cups
- Ideal for lifting of items with flat, smooth surfaces such as glass up to 60 kilos

ITEM ID:	Suction Cups	Max Load Kg	Cup Diameter mm	Weight g
SL02	2	60	118	600



DOLLY

- For panel beating of sheet metal
- Use together with TengTools body working hammers

ITEM ID:	Shape	Length mm	Width mm	Height mm	Weight g
AT415	Curved	128	58	40	1100
AT420	Heel	80	60	30	900



HAMMER BODY CROWN FACE STRAIGHT PEIN

- Double headed with a round crown face and straight pein
- Forged alloy steel head for durability
- Mirror polished face for a better contact with the metal
- Hickory handle for a traditional finish

ITEM ID:	Face Diameter mm	Weight g
HMBH01	32.5	400



HAMMER BODY CROWN FACE POINT PICK

- Double headed with a round crown face and round point pick head
- Forged alloy steel head for durability
- Mirror polished face for a better contact with the metal
- Hickory handle for a traditional finish

ITEM ID:	Face Diameter mm	Weight g
HMBH02	32.5	350



HAMMER BODY CROWN FACE SQUARE MILLED

- Double headed with a round crown face and square milled face
- Forged alloy steel head for durability
- Mirror polished crown face for a better contact with the metal
- Milled cross hatched surface on the square head for shrinking metal work on larger flat surfaces
- Hickory handle for a traditional finish

ITEM ID:	Face Diameter mm	Weight g
HMBH03	32.5	400



DEAD BLOW HAMMER

- Dead blow hammer
- Head filled with steel balls to prevent the hammer from bouncing
- Dead blow action particularly useful to reduce marking on the surface being hit

ITEM ID:	Face Diameter mm	Weight g
HMDH35	35	300
HMDH45	45	490
HMDH55	55	980
HMDH65	65	1365



TT SERIES

4

5 Pieces

BODYWORK HAMMER SET TT4 5 PIECES

- A selection of hammers for use in the automotive body shop or metal working area

Hammers:

Dead blow hammers with 35 and 55mm diameter heads, crown face hammers with straight pein, pick heads and square milled face

Item ID: TTPSAD

SERVICE TOOLS

DESIGNED TO HELP YOU GET THE JOB DONE

This range of service tools have been developed for you to do what you do best everyday. Here you will find tools that will help you perform most general service tasks more efficiently. All TengTools service tools have been manufactured to exceed the demands of professional users.



GREASE GUN

- Lever style grease gun for use with 400g cartridges or up to 500cc bulk grease
- Grease is fed to the high pressure mechanism by fully opening the lever
- Supplied with pipe and hydraulic coupling (thread G(R) 1/8")

Item ID: **AT500**



4" TWO/THREE ARM GEAR PULLER

- Simple to use three legged puller for the fast removal of pulleys, wheels and bearings
- Spread of 76mm to 102mm and a maximum reach of 89mm
- The special yoke can also be used to convert from three legged to two legged pulling

Item ID: **SP11**



TWO/THREE ARM PULLER

- Simple to use three legged puller for the fast removal of pulleys, wheels and bearings
- Designed for internal or external pulling with easily reversible legs
- The special yoke can also be used to convert from three legged to two legged pulling

ITEM ID:	Clamping Depth mm	Span Width mm	Weight g
SPA11	100	50-100	1080
SPA22	170	60-150	2600



7" TWO/THREE ARM GEAR PULLER

- Simple to use three legged puller for the fast removal of pulleys, wheels and bearings
- Spread of 75mm to 175mm and a maximum reach of 137mm
- The special yoke can also be used to convert from three legged to two legged pulling

Item ID: **SP22**



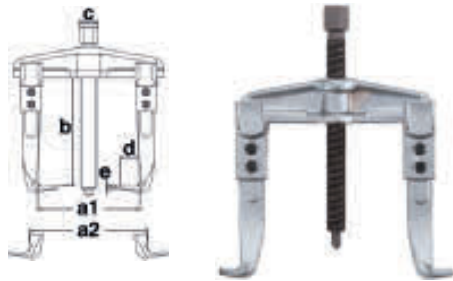

TWO ARM UNIVERSAL PULLER

- Simple to use two legged puller for the fast removal of pulleys, wheels and bearings
- Designed for internal or external pulling with easily reversible legs
- Strong drop forged construction for strength and durability

ITEM ID:	a			Spindle Thread	Spindle Length			c	d	e	Weight g
	mm	mm	mm		mm	mm	mm				
SP1410	90	133	100	M14 x 1.5	140	17	12	3.4			1100
SP1810	130	170	100	M14 x 1.5	140	17	12	3.4			1300
SP2215	160	220	150	M20 x 2.0	210	22	20	3.8			3200
SP2615	200	256	150	M20 x 2.0	210	22	20	3.8			3600
SP3320	250	325	200	M26 x 2.0	280	27	27	6.2			7800

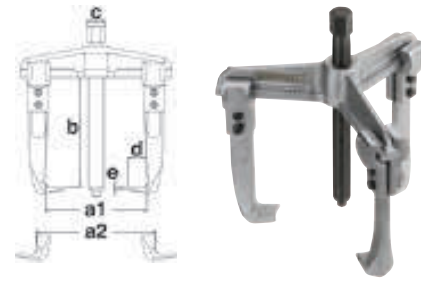

THREE ARM UNIVERSAL PULLER

- Simple to use three legged puller for the fast removal of pulleys, wheels and bearings
- Designed for internal or external pulling with easily reversible legs
- Strong drop forged construction for strength and durability

ITEM ID:	a			Spindle Thread	Spindle Length			c	d	e	Weight g
	mm	mm	mm		mm	mm	mm				
SP31410	90	140	100	M14 x 1.5	140	17	12	3.4			1400
SP31810	130	180	100	M14 x 1.5	140	17	12	3.4			1600
SP32215	160	220	150	M20 x 2.0	210	22	20	3.8			3500
SP32615	205	260	150	M20 x 2.0	210	22	20	3.8			4200
SP33320	252	330	200	M26 x 2.0	280	27	27	6.2			8800

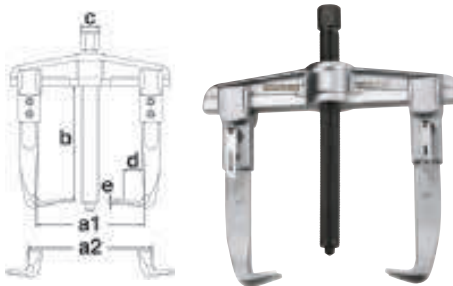

TWO ARM QUICK ACTION PULLER

- Simple to use two legged puller for the fast removal of pulleys, wheels and bearings
- Quick lock action on the legs for fast adjustment
- Designed for internal or external pulling with easily reversible legs
- Strong drop forged construction for strength and durability

ITEM ID:	a			Spindle Thread	Spindle Length			c	d	e	Weight g
	mm	mm	mm		mm	mm	mm				
SP1410Q	90	130	100	M14 x 1.5	140	17	12	3.4			1100
SP1810Q	130	170	100	M14 x 1.5	140	17	12	3.4			1200
SP2215Q	158	209	150	M20 x 2.0	210	22	20	3.8			3000
SP2615Q	200	256	150	M20 x 2.0	210	22	20	3.8			3400
SP3320Q	250	325	205	M26 x 2.0	280	27	27	6.2			7000

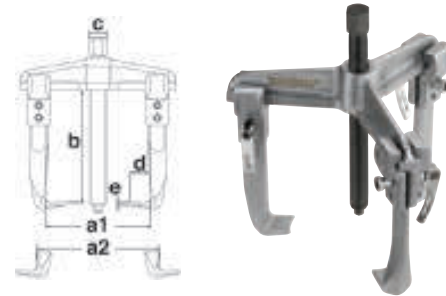

THREE ARM QUICK ACTION PULLER

- Simple to use three legged puller for the fast removal of pulleys, wheels and bearings
- Quick lock action on the legs for fast adjustment
- Designed for internal or external pulling with easily reversible legs
- Strong drop forged construction for strength and durability

ITEM ID:	a			Spindle Thread	Spindle Length			c	d	e	Weight g
	mm	mm	mm		mm	mm	mm				
SP31410Q	90	130	100	M14 x 1.5	140	17	12	3.4			1500
SP31810Q	130	170	100	M14 x 1.5	140	17	12	3.4			1600
SP32215Q	160	210	150	M20 x 2.0	210	22	20	3.8			3900
SP32615Q	205	260	150	M20 x 2.0	210	22	20	3.8			4200
SP33320Q	252	330	205	M26 x 2.0	280	27	27	6.2			8600



TT SERIES
1

4 Pieces

PULLER SET TTI 4 PIECES

- Three legged combination puller
- Supplied with an extra yoke for switching to two legged pulling
- Reversible legs for internal or external grip

Pullers:
Combination twin/triple 6" leg puller with 4" capacity

Item ID: TT804



5 Pieces

PULLER SET WITH STAND

- A set of 5 two arm pullers complete with stand
- Strong, drop forged design for fast removal of pulleys, wheels and bearings
- Use as a set in a workshop giving a range of spreads from 90 to 250mm internal or 133 to 325mm external pullers
- Easily interchangeable between internal or external

2 Arm Pullers:
90/133mm spread, 130/170mm spread, 158/209mm spread, 200/256mm spread, 250/325mm spread

Item ID: DIS-SP05



5 Pieces

PULLER SET QUICK TYPE WITH STAND

- A set of 5 two arm pullers complete with stand
- Strong, drop forged design for fast removal of pulleys, wheels and bearings
- Quick lock action on the legs for fast adjustment
- Use as a set in a workshop giving a range of spreads from 90 to 250mm internal or 133 to 325mm external pullers
- Easily interchangeable between internal or external

2 Arm Pullers:
90/133mm spread, 130/170mm spread, 158/209mm spread, 200/256mm spread, 250/325mm spread

Item ID: DIS-SP05Q



1/4" SCREW EXTRACTOR

- For use with a 1/4" drive impact driver
- Spiral design for removing damaged screws
- A quick and easy way to remove broken screws, pipes, bolts and studs

ITEM ID:	Size	Length mm	Weight g
SE141	1	50	12
SE142	2	50	12
SE143	3	50	12



SCREW EXTRACTOR

- Screw extractor
- Tapered designed for removing damaged screws
- Suitable for both clockwise and anti-clockwise threads
- Square shank and manufactured in CR-V 6150 steel hardened to HRC50-52

ITEM ID:	For Drill Hole mm	Weight g
SEL01S	3mm (1/8")	13
SEL02S	4mm (3/16")	22
SEL03S	5mm (15/64")	36
SEL04S	7mm (5/16")	52
SEL05S	9mm (3/8")	148



5 Pieces

SCREW EXTRACTOR SET SPIRAL 5 PIECES

- Spiral design for removing damaged screws
- A quick and easy way to remove broken screws, pipes, bolts and studs
- Use with drill sizes 7/64", 9/64", 5/32", 1/4" and 19/64"
- Use with the TengTools tap handle (TAP-HNDL)
- Supplied in a handy storage case

Item ID: **SE05**



1/2"

1/2" STUD EXTRACTOR SOCKET

- Designed for removing rounded or damaged bolts and studs
- Reversible enabling use on clockwise and anti-clockwise threads
- Use together with a 1/2" drive ratchet and accessories
- Chrome vanadium, satin finish

ITEM ID:	Drive	Size mm
ST12506-C	1/2"	6
ST12508-C	1/2"	8
ST12510-C	1/2"	10
ST12512-C	1/2"	12

REPAIR KIT STUD EXTRACTORS ST12506 - ST12512

ITEM ID:	For use with:
ST12506RK-1	ST12506-C
ST12508RK-1	ST12508-C
ST12510RK-1	ST12510-C
ST12512RK-1	ST12512-C



5 Pieces

5 PIECE SCREW EXTRACTOR SET

- Tapered design for removing damage screws
- Suitable for both clockwise and anti-clockwise threads
- Square shank and manufactured in CR-V 6150 steel hardened to HRC50-52
- Use with drill sizes 3, 4, 5, 7 and 9mm
- Use with the TengTools tap handle (TAP-HDL)
- Supplied in the unique TengTools TJ tray
- Clear fold up lid to see which set you need to use
- Sliding catch to secure the set when not in use
- Box equipped with a belt clip to keep tools in easy reach

Item ID: **TJSE05S**



2 Pieces

NUT SPLITTER SET

- Simply tighten the thread to engage the blade and split stubborn nuts
- Capacities 5 to 20mm and 14 to 27mm

Item ID: **NS02**

REPAIR KIT NUT SPLITTER NS02

ITEM ID:	Description
NS02RKS	Small
NS02RKL	Large



3/8"

1/2"

STUD EXTRACTORS

- Designed for removing rounded or damaged bolt heads, nuts and studs
- Use together with a ratchet and accessories
- Chrome vanadium, satin finish

ITEM ID:	Drive	Size mm	Size AF	L mm	T mm	D1 mm	D2 mm	Weight g
ST38306	3/8"	6	1/4"	27	11	15.9	9.9	21
ST38308	3/8"	8	5/16"	27	11	15.9	12	23
ST38112	3/8"	-	3/8"	27	11	15.9	14.2	22
ST38310	3/8"	10	-	27	11	19	15.3	33
ST38311	3/8"	11	7/16"	27	11	19	15.6	33
ST38312	3/8"	12	-	27	11	19	17.4	33
ST38116	3/8"	-	1/2"	27	11	19	17.7	34
ST38313	3/8"	13	-	27	11	19	18.7	35
ST38314	3/8"	14	9/16"	27	11	22.2	20.7	50
ST38316	3/8"	16	5/8"	27	11	22.2	22.1	50
ST38317	3/8"	17	-	27	11	25.4	24.8	74
ST38122	3/8"	-	11/16"	27	11	25.4	24.8	74
ST12319	1/2"	19	3/4"	44.5	11	27	26.6	167
ST12321	1/2"	21	13/16"	44.5	12.5	32	28	199
ST12322	1/2"	22	7/8"	44.5	12.5	35	30.7	210
ST12324	1/2"	24	15/16"	44.5	12.5	36	32.4	210
ST12325	1/2"	25	1"	44.5	12.5	36	33.4	214



1/2"

1/2" STUD EXTRACTOR ECCENTRIC

- For inserting and extracting stud bolts
- One eccentric knurled contact wheel grips the stud against an internal fluting
- Suitable for use with stud bolts from 5.5 to 19mm diameter thread

Item ID: **2300**



TT
SERIES
1

11
Pieces
1/2"

EXTRACTOR & NUT SPLITTER SET TTI

- Includes screw extractors, stud extractors and nut splitters
- Ideal for use with broken nuts, bolts, studs or screws

1/2" Drive Stud Extractors:

6, 8, 10, 12 mm

Screw Extractors:

7/64", 9/64", 5/32", 1/4", 19/64"

Nut Splitters:

5 to 20mm, 14 to 27mm

Item ID: **TTSN11**



TT
SERIES
1

18
Pieces
3/8" 1/2"

STUD EXTRACTOR SET TTI 18 PIECES

- Includes all the most commonly used sizes from 6mm (5/16") to 25mm (1")
- Designed for removing rounded or damaged bolt heads or nuts
- 4mm parallel pin punch included for clearing debris from the extractors
- Chrome vanadium satin finish
- Designed and manufactured to DIN3120/3124 and ISO2725

3/8" Drive Stud Extractors:

6 (5/16"), 8, 10 (3/8"), 11 (7/16"), 12, 13 (1/2"), 14 (9/16"), 16 (5/8"), 17 mm

1/2" Drive Stud Extractors:

19, 21, 22, 24, 25 mm

3/4", 13/16", 7/8", 15/16", 1"

Parallel Pin Punch:

4mm (150mm length)

Item ID: **TTBE18**



PRY BAR ROLL HEEL TYPE

- Roll or heel type design for opening and separating
- Tapered podger style handle for aligning holes prior to fixing
- Designed for use in construction such as scaffolding, pallet racking, shelving systems and metal panel erection

ITEM ID:	Size AF	Size mm
PB12	12"	300
PB16	16"	400
PB20	20"	500



PRY BAR

- Heavy duty with a power thru handle for use with a hammer
- Straight handle with a forked tip also suitable for use on nails, etc

ITEM ID:	Size AF	Size mm
PB12A	12"	300
PB18A	18"	450
PB22A	22"	550



WRECKING BAR

- Three functions in one handy tool
- Use as a lever for removing nails, etc.
- Ideal for use in confined spaces
- Sturdy steel construction (1045 medium carbon steel)

ITEM ID:	Overall Length
PF190	190mm (7-1/2")
PF380	380mm (15")



TT
SERIES
x4

3
Pieces

PRY BAR SET ROLL/HEEL TTX4 3 PIECES

- Includes roll/heel bars in three sizes to suit different applications

Roll heel bars:

12", 16", 20"

Item ID: **TTXPB3**



TT
SERIES
x4

3
Pieces

PRY BAR SET TTX4 3 PIECES

- Includes pry bars in three sizes and shapes to suit different applications

Roll heel bars:

12", 18", 22"

Item ID: **TTXPB3A**



FOAM
SERIES
x4

4
Pieces

PRY BAR SET ROLL/HEEL FOAMX4 4 PIECES

- Includes 3 roll/heel bars and a 20" tyre lever
- Tools are held in place using three colour pre-cut EVA foam

Roll heel bars:

12", 16", 20"

Tyre Lever:

20"

Item ID: **TEXPB4**



RATCHETING CRIMPING PLIER WITH 3 HEADS

- Interchangeable ratchet crimping tool
- Automatic locking mechanism to ensure a consistent and correct crimping action
- Use on insulated, non insulated terminals and connectors
- Release function

Item ID: **CP52**

REPLACEMENT DIES FOR CP52

ITEM ID:	Insulated Terminals mm ²	Non-Insulated Terminals mm ²
CP04RK1	0.324 – 5.261	
CP04RK2		0.324 – 3.31
CP04RK3	0.3 – 8.0	



RATCHETING CRIMPING PLIER

- Compound ratchet action giving 30% extra strength
- Suitable for use with red, blue and yellow insulated terminals and connectors
- Automatic locking mechanism to ensure a consistent and correct crimping action
- Release function

Item ID: **CP58**

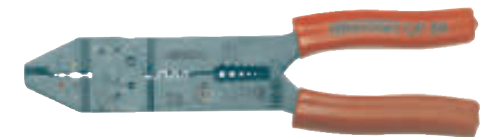

CRIMPING PLIER

- Use on insulated, non insulated terminals and connectors
- Wire stripping capacity from 0.75 to 6mm
- Cutting function for M2.5 to M5 bolt sizes
- Plastic grips for more comfortable use

Item ID: **CP50**



CRIMPING PLIER

- Use on insulated, non insulated terminals and connectors
- Wire stripping capacity from 0.75 to 6mm
- Cutting function for M2.5 to M5 bolt sizes
- Plastic grips for more comfortable use

Item ID: **CP51**



CRIMPING AND WIRE STRIPPING PLIER

- Use on insulated, non insulated terminals and connectors
- Wire stripping capacity from 0.8 to 3.2mm²
- Cutting capacity 1.0mm copper cable
- Return spring for repeated use
- Locking action for easier storage

Item ID: **CP53**



RATCHETING WIRE STRIPPING PLIER

- Includes wire cutting and crimping functions
- Easily strips cable between 0.2 and 8.0mm²
- Suitable for crimping insulated and non insulated terminals and connectors
- Return spring action for easier repeated use

Item ID: **CP60**



TT
SERIES



121
Pieces

CRIMPING PLIER SET TT1 121 PIECES

- Multi function 9" crimping plier and wire stripper
- Use on insulated, non insulated terminals and connectors
- Wire stripping capacity from 0.75 to 6mm
- Cutting function for M2.5 to M5 bolt sizes
- Includes a range of insulated, non insulated terminals and connectors

Crimping Tool:

Multi function CP50 crimping tool

Terminals/connectors:

- Red #6 ring terminals x 20
- Blue #8 spade terminals x 20
- Red butt connectors x 20
- Blue butt connectors x 20
- Blue 6.3x0.8mm female connectors x 20
- Blue 6.3x0.8mm male connectors x 20

Item ID: **TTCP121**



TT
SERIES



4
Pieces

CRIMPING PLIER SET TT1 4 PIECES

- Interchangeable ratchet crimping tool
- Automatic locking mechanism to ensure a consistent and correct crimping action
- Includes a range of interchangeable heads
- Use on insulated, non insulated terminals and connectors

Crimping Tool:

Changeable ratchet crimping tool for insulated terminals 22-10 AWG

Terminals/connectors:

Die for non-insulated open barrel connector, commercial type 22-12 AWG (0.324 square mm - 3.31 square mm)

Die for non-insulated terminals 22-8 AWG (0.3 square mm - 8 square mm)

Other Tools:

Hex key wrench 2.5mm

Item ID: **TTCP04**



WIRE STRIPPING PLIER GUN TYPE

- Easy to use pistol grip action
- Hardened SK5 steel blade for fast accurate wire stripping
- Wire stripping capacity 24-10 AWG or 0.2 to 6mm²
- Built in wire cutter cuts up to 2mm diameter electrical wire

Item ID: **CP55**



WIRE TWISTING PLIER

- Normally used for wire locking nuts particularly in safety critical areas
- Slim nose design for optimum manoeuvrability
- Heavy duty locking jaws and return spring for durability and easier use
- Forged high carbon steel with polished jaws
- 1.0mm cutting capacity for stainless steel and inconel wire

ITEM ID:	Length		Weight g
	AF	mm	
AT605	6	150	250



CABLE TIE GUN

- Ideal for repeated actions
- Works with plastic cable ties from 2.2 to 4.8mm width
- Adjustable tensile strength to avoid over tightening

Item ID: **CTG01**



CIRCUIT TESTER

- Brass with steel probe and screw on cover
- Suitable for use between 6 and 24 volts
- 850mm cable with simple alligator grip
- Replacement bulb widely available (24 volt, 5 watt festoon type bulb)
- Simple to use to check if circuits are live and intact

Item ID: **9850**



VOLTAGE TESTER

- Insulated voltage tester for use from 100 to 250 volts
- Overall length 145mm, blade length 70mm

Item ID: MDV9855



DIGITAL MULTIMETER

- Ideal for automotive or industrial maintenance
- Extra large digital display with 16mm digits
- Fold out stand for easier use
- Use to measure voltage in DC or AC and DC current
- Includes a diode and continuity tester
- Measure temperature with the temperature probe
- Supplied with test leads
- Uses 2 AAA batteries (supplied)
- CAT I 600 volts, CAT II 300 volts, IEC61010

Specifications:		
DC Voltage	Volts	250V
AC voltage	Volts	250V
Resistance	Ohms	200Ω - 2-20-200 KΩ -20MΩ
Temperature	°Celsius	-40 to +1,000

Item ID: DM550

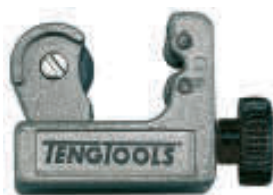

PIPE CUTTER 3-22MM

- Designed for cutting copper and brass pipes
- Capacity 3 to 22mm (1/8" to 7/8")
- One cutting wheel and two rollers to give a consistent and straight cutting edge
- Ideal for use in confined spaces

Item ID: TF22

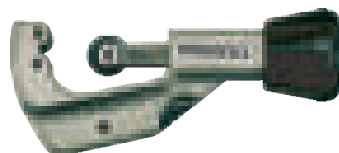

PIPE CUTTER 3-32MM

- Heavy duty cutter complete with a spare blade
- A retractable reamer is built in to the frame to deburr rough edges
- Capacity 3 to 32mm (1/8" to 1-1/4")
- One cutting wheel and two rollers to give a consistent and straight cutting edge

Item ID: TF30



REPLACEMENT BLADES ROTATING PIPE CUTTER

- 2 spare pipe cutter cutting wheels
- Suitable for TengTools TF22 and TF30 pipe cutters

Item ID: TF2230RK



PIPE CUTTER 6-76MM

- Heavy duty cutter with a light weight aluminium frame
- A retractable reamer is built in to the frame to deburr rough edges
- Capacity 6 to 76mm (1/4" to 3") in thin and thick walled copper, brass and aluminium pipe
- Also suitable for cutting plastic pipes with a diameter of 16 to 76mm (5/8" to 3")
- One cutting wheel and two rollers to give a consistent and straight cutting edge

Item ID: TF76



SPARE PIPE CUTTER BLADES FOR TF76

- 5 spare pipe cutter cutting wheels
- Suitable for TengTools TF76 pipe cutters

Item ID: TF76RK

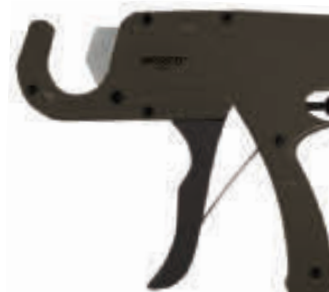

PIPE CUTTER 42MM CAPACITY PE TUBING

- Cuts PEX or XLPE polythene tubing and other similar soft plastic piping up to 42mm diameter
- Gives a right angled and burr free cut
- A pistol grip style handle for more comfortable use
- A simple ratchet mechanism engages the cutter step by step to give more control over the cutting action

Item ID: TFP01



REPLACEMENT BLADES PIPE CUTTER TFP01

- Replacement cutting blade for the TengTools TFP01 pipe cutter

Item ID: TFP01RK



PIPE CUTTER 42MM CAPACITY PLASTIC

- Cuts PEX or XLPE polythene tubing and other similar soft plastic piping up to 42mm diameter
- Gives a right angled and burr free cut
- Designed to give a more comfortable grip
- A simple ratchet mechanism engages the cutter step by step to give more control over the cutting action

Item ID: TFP02



REPLACEMENT BLADES PIPE CUTTER TFP02

- Replacement cutting blade for the TengTools TFP02 pipe cutter

Item ID: TFP02RK



ROTATING PIPE CUTTER

- Rotating pipe cutter
- Ideal for cutting plastic, brass and copper pipes
- Simply rotate around the pipe to create a clean and straight cut

ITEM ID:	Pipe Diameter mm
TFA10	10
TFA12	12
TFA15	15
TFA22	22
TFA0252RK	5 spare wheels



PIPE CUTTER CHAIN TYPE

- For cutting thin walled pipes in stainless steel, copper, & pvc up to a thickness of 1.5mm
- Self locking with a non-pinch, one hand operation for easy use
- A locking nut on the adjustment knob can be used to preset the capacity
- 15 cutting wheels on the chain for an easy cutting action

Item ID: **TF300**



REPLACEMENT PIPE CUTTER CHAIN

- Replacement chain for the TengTools TF300 pipe cutter
- Fittings included

Item ID: **TF300RK**



PIPE REAMER

- For deburring copper, aluminium and brass pipes
- Suitable for pipe diameters from 3 to 41mm
- Cutters at both ends for internal and external deburring

Item ID: **DBT41**



ALUMINIUM PIPE REAMER

- For deburring pipes of all types
- Cutters at both ends for internal and external deburring

ITEM ID:	Pipe Diameter mm
DBT35	8 to 35mm
DBT54	10 to 54mm



DEBURRING TOOL

- Suitable for deburring operations on pipes, holes, edges, etc
- HSS blade knives are swivel mounted to automatically adapt to the shape of the piece
- Supplied with 2 HSS knife blades

ITEM ID:	Description
DET01	Deburring tool
DET01RK	2 spare blades



DEBURRING TOOL POCKET CLIP

- Suitable for deburring operations on pipes, holes, edges, etc
- HSS blade knives are swivel mounted to automatically adapt to the shape of the piece
- Handy pocket clip for added convenience

Item ID: **DET02**



TELESCOPIC BASIN TAP WRENCH

- For reaching taps behind the bath or basin
- Spring loaded serrated jaw quickly grips on nuts and pipes
- Capacity 32 to 48mm
- Telescopic handle for even easier access in difficult to reach places
- Extends from 275 to 400mm

Item ID: **BWT406**



TT SERIES

6 Pieces

PIPE CUTTER SET TTI 6 PIECES

- For cutting plastic, copper and brass pipes from 3 to 22mm diameter
- Deburring tool included for tidying up any sharp edges

Pipe Cutters:
Capacity: 10, 12, 15, 22 mm
Adjustable pipe cutter capacity: 3-22 mm
Accessories:
Deburring tool

Item ID: **TTTC06**



CHAIN PIPE WRENCH

- Fully adjustable heavy duty chain
- Designed for mounting and unmounting pipes, etc.
- Suitable for tasks where round items need to be gripped
- Strong, drop forged steel handle for high leverage
- Grips pipes, etc up to 100mm diameter

Item ID: **9124**



HAND RIVET GUN

- For professional use in metal work, industry and construction
- Comfortable PVC grip

ITEM ID:	Aluminium	Steel	Stainless	Length	Weight
	mm	mm	mm		
HR12	2.4/3.2/4.0/4.8	2.4/3.2/4.0/4.8	2.4/3.2/4.0	250	560
HR12RK	Spare parts set				

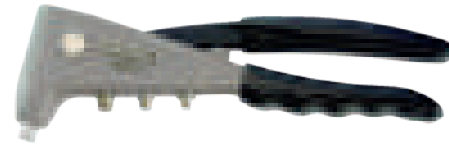

HAND RIVET GUN

- For professional use in metal work, industry and construction
- Comfortable PVC grip

ITEM ID:	Aluminium	Steel	Stainless	Length	Weight
	mm	mm	mm		
HR30R	2.4/3.0/3.2/4.0/4.8	2.4/3.0/3.2/4.0/4.8	2.4/3.0/3.2/4.0/4.8	270	560
HR30RRK-1	Service Kit - Replacement nose pieces				
HR30RRK-2	Service Kit - Jaw pusher assembly				



HAND RIVET GUN WITH SWIVEL HEAD

- Swivel head function to enable use at an angle or in confined spaces
- For professional use in metal work, industry and construction
- Comfortable PVC grip

ITEM ID:	Aluminium	Steel	Stainless	Length	Weight
	mm	mm	mm		
HR360R	2.4/3.0/3.2/4.0/4.8/5.0	2.4/3.0/3.2/4.0	2.4/3.0/3.2	295	712
HR12RK	Spare parts set				



LONG HANDLED RIVET GUN

- For professional use in construction and industrial applications
- Two handed grips gives a much higher capacity
- 3 jaw sizes included
- Plastic container collects the spent mandrels
- Nose bushes for rivet diameter 3.2, 4.0, 4.8, 6.0 and 6.4mm

ITEM ID:	Description
HRLR01	Rivet Gun
HRLR01RK-2	Service Kit - Replacement nose pieces
HRLR01RK-3	Service Kit - Jaw pusher assembly



HAND RIVET GUN

- Heavy duty steel plate construction
- Jaw and case made from heat treated steel alloy
- Comfortable PVC grip

ITEM ID:	Aluminium	Steel	Length	Weight
	mm	mm	mm	g
HR14	2.4/3.0/3.2	2.4/3.0/3.2	270	627
HR14RK	Spare parts set			



HAND RIVET GUN

- Aluminium alloy, forged steel upper handle with heat treated jaws for durability and easier use
- Comfortable PVC grip

ITEM ID:	Aluminium	Steel	Length	Weight
	mm	mm	mm	g
HR01	2.4/3.2/4.0/4.8	2.4/3.2/4.0/4.8	250	560
HR01RK	Spare parts set			



LAZY TONGUE RIVET GUN

- For professional use in construction and industrial applications
- Lazy tongue design and function gives an increased riveting force
- Suitable for use in confined spaces
- 3 jaw sizes included
- Nose bushes for rivet diameter 3.2, 4.0, 4.8, 6.0 and 6.4mm

ITEM ID:	Description
HRLT01	Rivet Gun
HRLT01RK	Spare parts set



NUTSERT GUN

- Aluminium alloy, forged steel upper handle with heat treated jaws
- Quick change, lockable threaded mandrels
- Mandrels for M3, M4, M5 and M6 included
- Comfortable PVC grip

ITEM ID:	Aluminium	Length	Weight
	mm	mm	g
HN02	M3 x 0.5, M4 x 0.7, M5 x 0.8, M6 x 1.0	250	800
HN02RK	Spare parts set		



LONG HANDLED NUSERT GUN

- For professional use in construction and industrial applications
- Two handed grips gives a much higher capacity
- Draw rod compound action for quick loading and unloading
- Mandrels for M5, M6, M8 and M10 included
- Supplied in a metal case for storage and safe keeping

ITEM ID:	Aluminium mm	Length mm	Weight g
HRLN65N	M5, M6, M8, M10	530	1800
HRLN65NRK-1	Spare parts set		



TT
SERIES



81
Pieces

RIVET GUN SET TT1 81 PIECES

- Aluminium alloy, forged steel upper handle with heat treated jaws for durability
- Suitable for aluminium and steel rivets from 2.4 to 4.8mm and stainless steel rivets up to 4.0mm
- Includes 80 assorted rivets in individual storage compartments

Hand rivetter:
4 nozzles to suit aluminium/steel blind rivets (2.4, 3.2, 4.0, 4.8 mm)
Aluminium rivets:
2.4mm (3/32") x 20 black
3.2mm (1/8") x 20 black
4.0mm (5/32") x 20 black
4.8mm (3/16") x 20 black
Accessories:
Nozzle wrench

Item ID: **TTHR81**

FOAM
SERIES



81
Pieces



RIVET GUN SET FOAM1 81 PIECES

- Aluminium alloy and forged steel construction
- Light weight design for more comfortable use
- PVC grip for added comfort
- Suitable for use with 2.4, 3.2, 4.0 and 4.8mm rivets
- Selection of rivets included
- Tools are held in place using three colour pre-cut EVA foam

Hand rivetter:
4 nozzles to suit aluminium/steel blind rivets (2.4, 3.2, 4.0, 4.8 mm)
Aluminium rivets:
2.4mm (3/32") x 20 black
3.2mm (1/8") x 20 black
4.0mm (5/32") x 20 black
4.8mm (3/16") x 20 black
Accessories:
Nozzle wrench

Item ID: **TEAHR81**



TT
SERIES



81
Pieces

NUSERT GUN SET TT1 81 PIECES

- Aluminium alloy, forged steel upper handle with heat treated jaws for durability
- Quick change, lockable threaded mandrels
- Mandrels for M3, M4, M5 and M6 included
- Includes 80 assorted nutserts in individual storage compartments

Nutsert Tool:
4 quick change mandrels (M3 x 0.5, M4 x 0.7, M5 x 0.8, M6 x 1.0)
Aluminium rivets:
M3 x 20 pieces
M4 x 20 pieces
M5 x 20 pieces
M6 x 20 pieces
Accessories:
Nose piece wrench

Item ID: **TTNR81**



SCRIBER

- Knurled handle to give a better grip when scribing or marking materials
- Handy pocket clip for storing while being used

ITEM ID:	Length mm	Diameter mm
SCR01	135	7



SCRIBER WITH CARBIDE TIP

- Hard tungsten carbide tip (K20 grade) for durability and clear marks when scribing
- Handy pocket clip for storing while being used

ITEM ID:	Length mm	Diameter mm
SCR02	150	6



CLAW PICK UP TOOL

- Excellent for reaching small items lost in hidden areas
- Flexible wire with non magnetic claws for minimal interference
- Press action to expand and contract the jaws to easily grip items
- Overall length 600mm

Item ID: **AT135**

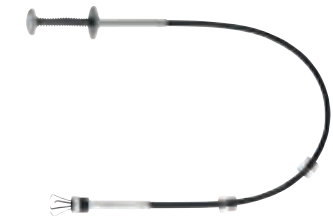

MAGNETIC CLAW PICK UP TOOL

- Excellent for reaching small items lost in hidden areas
- Flexible wire for minimal interference
- Magnetic collar to retrieve ferrous material items
- Press action to expand and contract the jaws to easily grip items
- Overall length 600mm

Item ID: **AT135M**



TELESCOPIC MAGNIFYING GLASS

- Adjustable head to help find items
- Ideal for finding lost nuts and bolts
- Extends to 960mm
- Glass diameter: 60mm
- Includes a pocket clip

Item ID: **581TMG**



TELESCOPIC INSPECTION MIRROR

- Adjustable head to help find items
- Ideal for finding lost nuts and bolts
- Extends to 960mm
- Mirror diameter 57mm
- Includes a pocket clip

Item ID: **581TMI**



TELESCOPIC PICK UP TOOL 760MM

- Extra strong magnet with a 4,500g lifting force
- Ideal for retrieving lost nuts and bolts
- Extends to 760mm
- Includes a pocket clip

Item ID: **581TMP**



TELESCOPIC PICK UP TOOL 550MM

- Strong magnet with a 200g lifting force
- Ideal for retrieving lost nuts and bolts
- Extends to 55cm

Item ID: **SD501**



TELESCOPIC INSPECTION TOOL 3 IN 1

- Combines a magnet with a mirror and a scribe
- Telescopic with a strong magnet extending to 57cm
- Fully adjustable polished mirror to help locate dropped items
- Screw cap to reveal a handy etching scribe
- Complete with pocket clip for easy storage while working

Item ID: **582MI**



TELESCOPIC MAGNETIC PICK UP TOOL AND PEN

- Combines a magnet with a pen for making notes
- Telescopic with a very strong magnet extending to 63cm
- Screw cap to reveal a handy pen
- Complete with pocket clip for easy storage while working

Item ID: **585MP**



3 Pieces

INSPECTION SET TTI 3 PIECES

- Ideal set for finding and retrieving lost nuts and bolts, etc.
- An extending mirror and magnifier with adjustable heads
- The extending magnetic pick up tool helps retrieve items up to 4,500g
- Mirror & magnifying glass extend to 850mm and the magnet extends to 760mm

Inspection Tools:

- Telescopic magnifying glass
- Telescopic inspection mirror
- Telescopic magnetic pick up tool

Item ID: **TTTM03**



8 Pieces

INSPECTION SET TTI 8 PIECES

- Ideal set for finding and retrieving lost nuts and bolts, etc.
- Includes telescopic magnetic pick up, magnifying glass, inspection mirror, a flexible claw pick up and even an LED torch

Inspection Tools:

- LED flashlight
- Flexible magnetic pick up, length 310mm
- Telescopic magnetic pick up, length 160-480mm
- 38mm magnifying glass 1:3 with magnetic adaptor
- 38mm inspection mirror with magnetic adaptor
- 230mm flexible claw pick up tool
- Batteries AAA (2 pieces)

Item ID: **TTTM08**



LED TORCH WITH POCKET CLIP

- Satin, chrome plated brass body for a better grip
- Pocket clip for easy storage when working
- 25-30 lumen gives a bright light
- 45 degree light distribution illuminates a wider area
- Requires 2 AAA batteries (not included) typically giving 5.5 hours average usage

Item ID: **585**



TORCH POCKET CLIP

- LED light with a 200 lumens long lasting light
- Slide focus to adjust the beam width
- Beam illuminates up to 105 meters
- Shockproof body and IP 66 protection
- Pocket clip and pocket sized (132 mm length) for easy storage
- Requires 2 x AAA batteries (not included) for up to 13,5 hours usage

Item ID: **581N1**



TORCH 47MM LENGTH

- LED light with a 750 lumens long lasting light
- Slide focus to adjust the beam width
- Beam illuminates up to 178 meters
- Shockproof body and IP 66 protection
- Low battery indicator when battery strength falls below 15%
- Pocket sized (147 mm length) for easy storage
- Requires 3 x AAA batteries (not included) for up to 22 hours usage

Item ID: **582N1**



TORCH 205MM LENGTH

- LED light with a 1100 lumens long lasting light
- Slide focus to adjust the beam width
- Beam illuminates up to 239 meters
- Shockproof body and IP 66 protection
- Low battery indicator when battery strength falls below 15%
- Compact sized (205 mm length) for easy storage
- Requires 6 x AAA batteries (not included) for up to 38 hours usage

Item ID: **583N1**



LED HEAD LAMP

- Adjustable head band for a comfortable fit
- CREE technology to create a brighter, long lasting LED light
- Choice of two modes - high beam or low beam
- Requires 3 AA batteries (not included)
- Ideal for illuminating the work area while keeping the hands free

Specification:		
Width	mm	50
Height	mm	50
Length	mm	55
Luminous flux	lumen	250
Weight	g	110

Item ID: **586C**



LED HEAD LAMP

- Adjustable head band for a comfortable fit
- CREE technology to create a brighter, long lasting LED light
- Choice of two modes
- Requires 3 AA batteries (not included)
- Ideal for illuminating the work area while keeping the hands free

Specification:		
Width	mm	50
Height	mm	50
Length	mm	55
Luminous flux	lumen	250
Weight	g	110

Item ID: **586A**



MAGNETIC FLEXIBLE LED LIGHT

- 3 LED diodes give a good strong light
- Fully flexible neck to give a wide range of adjustment
- Magnetic attachment for fixing quickly and simply with no drilling required
- Can be easily fitted to any flat ferrous material surface
- Requires 3 LR44 batteries (not included)

ITEM ID:	Length mm	Diameter mm	Light Lumen	Power W	Weight g
587M	370	25	76.5	0.0009	67



FLEXIBLE LIGHT WITH MAGNET

- Flexible and adjustable to illuminate work areas
- Magnet on the end makes it ideal for seeing and then retrieving items from confined spaces
- Requires 2 AA batteries (not included)

Specification:		
Total length	mm	595
Flexible length	mm	400
Outside diameter	mm	10
Maximum magnetic force	g	750

Item ID: **586**



MAGNIFYING GLASS WITH LED

- Hand held magnifying glass
- 14 LED bulbs in a ring around the glass to illuminate the subject being viewed
- Requires 2 AAA batteries (not included)
- Mains adaptors available

ITEM ID:	Magnification	LED Output	
		Diameter mm	Lumens
587H	3	100	72

ADAPTOR FOR MAGNIFYING GLASS WITH LED

- Mains adaptor for 587H hand held magnifying glass
- Suitable for use with Australian or New Zealand style electrical sockets

ITEM ID:	Plug Adaptor Region
587AE	Europe
587AU	UK
587AA	Aus & NZ



KNEELING PAD 450X210MM

- Handy kneeling pad made from hard wearing EVA
- 30.5mm thick EVA provides a good cushion area for the knees
- Ideal for use when working on a hard floor surface

Item ID: **KP01**



KNEELING PAD 880X300MM

- Handy kneeling pad made from hard wearing EVA
- 30.5mm thick EVA provides a good cushion area for the knees
- Ideal for use when working on a hard floor surface

Item ID: **KP02**



KNEELING STORAGE PAD 480X320MM

- Handy kneeling pad made from hard wearing EVA
- 30.5mm thick EVA provides a good cushion area for the knees
- Ideal for use when working on a hard floor surface
- Individual cut out areas create storage spaces for small components

Item ID: **KP03**



MECHANICS WORK CHAIR

- Adjustable height to ensure a comfortable working position
- Padded seat with the TengTools logo
- Swivel castors to move around easily
- Handy storage shelf in the bottom of the stool keeping components close to hand

Specification:

Seat cushion diameter	mm	360
Storage area	mm	310x310
Adjustable height	mm	420-500
Weight	kg	6.3

ITEM ID:	Description
TCA06	Mechanics Work Chair
TCA06RK	Spare Parts for TCA06



MECHANICS CREEPER

- Six sturdy wheels and a strong construction
- Padded cushion with the TengTools logo
- Recesses in the frame for the elbows make the creeper more comfortable to use

Specification:

Width	mm	500
Height	mm	155
Length	mm	1,050
Weight	kg	8.5

Item ID: **TCA07**



MAGNETIC BRACELET

- An adjustable 340mm length bracelet
- Magnetic disc for holding metal items while working
- Ideal for use with nails, screws, nuts and bolts
- Holds items within easy reach while working

Item ID: **583M**



MAGNETIC BITS TRAY

- Stainless steel for longer life
- Plastic enclosed magnet to avoid damage to paintwork, etc
- Use for screws, nuts, washers, etc when disassembling
- Can be secured on it's side as well as upside down

Item ID: **580**



LARGE MAGNETIC BITS TRAY

- Square to hold more bulky items
- Stainless steel for longer life
- 4 plastic enclosed magnets to avoid damage to paintwork, etc
- Use for screws, nuts, washers, etc when disassembling
- Can be secured on it's side as well as upside down
- Ideal for use as a parts washing tray

Item ID: **580S**



LARGE MAGNETIC BITS TRAY

- Deep and rectangular to hold more bulky items
- Stainless steel for longer life
- 2 plastic enclosed magnets to avoid damage to paintwork, etc
- Use for screws, nuts, washers, etc when disassembling
- Can be secured on it's side as well as upside down

Item ID: **580A**



PLASTIC MAGNETIC BOWL

- Creates storage for small parts quickly and easily with no drilling required
- Can be easily fitted to any flat ferrous material surface
- Powerful magnet for secure fixing
- Ideal for using on the side of a roller cabinet

ITEM ID:	Diameter mm	Weight g
580Q	112	191
580R	150	400



WELDING MAGNET

- Ideal for holding sheet metal, pipes and tubes when welding
- Use to hold the pieces prior to and during welding
- Holds the material at 45° or 90° to ensure an exact angle
- Can be used on flat or round surfaces of ferrous materials

ITEM ID:	Holding Area mm	Max Width mm	Height mm	Magnetic Force N
MH75	75	120	82	27
MH90	90	160	100	27





QUICK CLAMP TOP LEVER

- For internal or external clamping
- Fast action lever clamp with a unique design
- Powerful lever bar makes it easy to apply the correct clamping force
- Bottom mounted lever makes the clamp quick and comfortable to use
- Easy release button makes it equally quick and easy to unclamp
- Protective caps on the pressure plates to prevent damage
- Bi-material grip on the handle for a better grip

ITEM ID:	Clamping Force N	Span Width mm	Clamping Capacity mm	Weight g
CMQ150	1580	85	150	580
CMQ300	1580	85	300	680
CMQ450	1580	85	450	790
CMQ600	1580	85	600	890



QUICK CLAMP BOTTOM LEVER

- For internal or external clamping
- Fast action lever clamp with a unique design
- Powerful lever bar makes it easy to apply the correct clamping force
- Top mounted lever makes the clamp quick and comfortable to use
- Easy release button makes it equally quick and easy to unclamp
- Protective caps on the pressure plates to prevent damage to the item being clamped
- Bi-material grip on the handle for a better grip

ITEM ID:	Clamping Force N	Span Width mm	Clamping Capacity mm	Weight g
CMQL150	1780	80	150	670
CMQL300	1780	80	300	780
CMQL450	1780	80	450	900



SCREW CLAMP

- Reinforced malleable cast iron arms for increased strength
- High quality profiled rail with serrations for stability
- Protective caps on the pressure plates to prevent damage to the item being clamped
- Bi-material grip on the handle for a better grip

ITEM ID:	Clamping Force N	Span Width mm	Throat Depth mm	Bar Dimension mm	Weight g
CMD12	1961	120	60	20.0 x 5.0	430
CMD16	2648	160	80	25.0 x 6.0	750
CMD20	3922	200	100	27.0 x 7.0	1120
CMD25	4903	250	120	29.0 x 9.0	1500
CMD30	4903	300	120	29.0 x 9.0	1590
CMD30A	5393	300	140	32.0 x 10.0	2050
CMD40	5393	400	140	32.0 x 10.0	2260
CMD40A	5393	400	175	32.0 x 10.0	2330
CMD50	4903	500	120	29.0 x 9.0	1940
CMD80	4903	800	120	29.0 x 9.0	2480



F-TYPE CLAMP SWIVEL HANDLE

- 180° swivel handle for extra torque and fast action
- Swivelling pressure plate to grip even when tilted
- High quality construction for increased clamping strength
- Bi-material grip on the handle for a better grip

ITEM ID:	Clamping Force N	Span Width mm	Throat Depth mm	Weight g
CMF16T	160	80	16.5x7.5	570
CMF20T	200	100	19.5x9.5	1010
CMF25T	250	120	22x10.5	1330
CMF30T	300	140	25x12	1960
CMF35T	300	100	25x12	1140



F-TYPE CLAMP FIXED HANDLE

- Fixed handle for fast action tightening and loosening
- Swivelling pressure plate to grip even when tilted
- High quality construction for increased clamping strength

ITEM ID:	Clamping Force N	Span Width mm	Throat Depth mm	Weight g
CMF16	160	80	16.5x7.5	480
CMF20	200	100	19.5x9.5	900
CMF25	250	120	22x10.5	1210
CMF30	300	140	25x12	1800
CMF35	300	120	25x12	1720



RATCHET CLAMP

- Ratchet lever mechanism for high pressure, fast action clamping
- The ratchet action prevents over tightening and resists vibration
- Ergonomic design lever handle with non slip release lever

ITEM ID:	Clamping Force N	Span Width mm	Throat Depth mm	Bar Dimension mm	Weight g
CMFQ20	3432	200	100	19.5 x 9.5	1130
CMFQ25	3922	250	120	22.0 x 10.5	1500
CMFQ30	4903	300	140	25.0 x 12.0	2260
CMFQ40	5393	400	120	25.0 x 12.0	2400



HINGE ADJUSTMENT WRENCH

- Specifically designed for adjusting exterior door and window hinges

ITEM ID:	Length mm	Diameter mm	Weight g
DHW1300	220	13	170
DHW1417	290	14 x 17	310
DHW1922	300	19 x 22	440



BALL PEIN HAMMER

- Double headed with a round pein and ball head
- Fibre glass shafted handle for reduced weight and durability
- A comfortable rubber type handle for a more secure grip

ITEM ID:	Head Weight oz	Overall Weight g	Head Diameter mm	Overall Length mm
HMBP12	12	550	28	280
HMBP16	16	600	30	320
HMBP24	24	1040	35	380
HMBP32	32	1280	39	380



ENGINEERS HAMMER

- Double headed with a square pein and a pointed head
- Fibre glass shaft with a comfortable, rubber type handle

ITEM ID:	Head Weight grams	Overall Weight g	Head Diameter mm
HMEG300	300	420	300
HMEG500	500	650	320
HMEG800	800	1000	350



SOFT FACE HAMMER

- Double headed with a nylon and a softer rubber type head
- Tubular steel shaft for extra strength
- A comfortable, perforated rubber type handle
- Soft face heads to reduce marking on the surface being hit

ITEM ID:	Weight g	Length mm
HMSF	670	320
HMSFRK	Replacement Head	



LUMP HAMMER

- Club style lump hammer
- 1.6 kilo (3-1/2lb) overall weight for heavy duty striking
- Ideal for use with cold chisels and other striking tools when extra force is needed
- Hanging hole which can be used together with a safety wire for added security when working at heights
- Steel handle for extra strength
- A comfortable, perforated rubber type handle for a more secure grip

ITEM ID:	Head Weight oz	Overall Weight g	Head Diameter mm	Overall Length mm
HMS1250	1250	1609	43	296



CARPENTERS CLAW HAMMER

- Double headed with a round pein
- Claw for removing nails, etc
- Hanging hole which can be used together with a safety wire
- Steel handle for extra strength when levering with the claw
- A comfortable, perforated rubber type handle

ITEM ID:	Head Weight oz	Overall Weight g	Head Diameter mm	Overall Length mm
HMCH08A	8	394	21.6	290
HMCH13A	13	552	27	335
HMCH16A	16	700	27	312
HMCH20A	20	765	30	340



CARPENTERS SHOCK ABSORBENT CLAW HAMMER

- Double headed with a round pein and a claw for removing nails, etc
- Hanging hole which can be used together with a safety wire
- One piece forged steel handle for extra strength
- Shock absorbent grip to reduce impact vibration when striking

ITEM ID:	Head Weight oz	Overall Weight g	Head Diameter mm	Overall Length mm
HMCHM16	16	723	29	333



CARPENTERS CARBON FIBRE CLAW HAMMER

- Double headed with a round pein and a claw for removing nails, etc
- Hanging hole which can be used together with a safety wire
- Carbon fibre handle gives extra force on impact
- A comfortable rubber type handle

ITEM ID:	Head Weight oz	Overall Weight g	Head Diameter mm	Overall Length mm
HMCHC16	16	686	28	327



CARPENTERS MAGNETIC CLAW HAMMER

- Double headed with a round pein and a claw for removing nails, etc
- Magnetic nail holder in the head for positioning nails on the first strike
- Hanging hole which can be used together with a safety wire
- Steel handle for extra strength when levering with the claw
- A comfortable, perforated rubber type handle

ITEM ID:	Head Weight oz	Overall Weight g	Head Diameter mm	Overall Length mm
HMCH16M	16	678	27.5	341



BRICK LAYERS MASONRY HAMMER

- Double headed with a square pein and a pick
- Ideal for cutting, cleaning and setting bricks, stonework or masonry
- A comfortable, perforated rubber type handle
- Hanging hole which can be used together with a safety wire

ITEM ID:	Head Weight oz	Overall Weight g	Head Diameter mm	Overall Length mm
HMBH16	16	733	23	291



PARALLEL PIN PUNCH

- Special tempered steel construction with hardened point for longer life
- Overall length 150mm with hexagon grip and rounded shaft area

ITEM ID:	Size mm	Length mm
PP03	3	150
PP04	4	150
PP05	5	150
PP06	6	150
PP07	7	150
PP08	8	150



CENTRE PUNCH

- Special tempered steel construction with hardened point for longer life
- Strike with a hammer for marking hard materials such as metal, etc.

ITEM ID:	Size mm	Length mm
CP04	4	150
CP05	5	150
CP08	8	150



AUTOMATIC CENTRE PUNCH

- Spring is compressed and then released when the tip is pushed down
- Use to create an indentation in the material to be marked
- 1mm diameter tip
- Handy pocket clip for storing while being used

Item ID: SCP01



FLAT COLD CHISEL

- Special tempered steel construction with hardened 18mm cutting edge for longer life
- For shaping, cutting and chipping hard materials such as metal, stone and concrete

ITEM ID:	Size mm	Length mm
CC150F	18	150
CC200F	25	200
CC250F	25	250
CC240F	26	240



CHISEL HAND PROTECTION GRIP

- Heavy moulded impact absorbing hand grip
- For protection when striking with a hammer
- Protective plate improves safety against accidental impact
- Ergonomic design to help avoid injuries to the hand
- For use with TengTools 200, 240 and 250mm cold chisels

ITEM ID:	Length mm	Width mm	Weight g
PCCAP	120	56	45



TT SERIES



9 Pieces

PUNSCH & CHISEL SET TT1 9 PIECES

- Flat cold chisel made from chrome molybdenum
- Pin punches made from chrome molybdenum

Punches:		
Centre	Length: 150 mm	5 mm
Parallel	Length: 150 mm	3, 4, 5, 6, 7, 8 mm
Flat cold chisels::		
150 mm		Width: 19 mm
200 mm		Width: 25 mm

Item ID: TTPC09



FOAM SERIES



14 Pieces

PUNCH & CHISEL SET FOAM2 14 PIECES

- Flat cold chisel made from chrome molybdenum
- Pin punches made from chrome molybdenum
- Automatic centre punch with spring loaded stroke for marking points quickly
- Tools are held in place using three colour pre-cut EVA foam

Punches:		
Centre	Length: 150 mm	4, 5, 8 mm, Automatic centre punch
Parallel	Length: 150 mm	3, 4, 5, 6, 7, 8 mm
Flat cold chisels::		
150 mm		Width: 19 mm
200 mm		Width: 25 mm
240 mm		Width: 26 mm
250 mm		Width: 25 mm

Item ID: TEDPC14



10 Pieces

PUNCH & CHISEL SET WALL RACK 10 PIECES

- Flat cold chisel made from chrome molybdenum
- Pin punches made from chrome molybdenum
- Supplied with a wall rack for fixing to the wall or a workbench

Punches:		
Centre	Length: 150 mm	5 mm
Parallel	Length: 150 mm	3, 4, 5, 6, 7, 8 mm
Flat cold chisels::		
150 mm		Width: 19 mm
200 mm		Width: 25 mm
250 mm		Width: 25 mm

Item ID: WRPC10



6 Pieces

PARALLEL PIN PUNCH SET 6 PIECES

- Special tempered steel construction with hardened point for longer life
- Overall length 150mm with hexagon grip and rounded shaft area
- Supplied with a handy storage holder

Punches:		
Parallel	Length: 150 mm	3, 4, 5, 6, 7, 8 mm

Item ID: PPS06



5 Pieces

PUNSCH & CHISEL SET 5 PIECES

- Includes a cold chisel, centre punch and 3 parallel pin punches
- Special tempered steel construction with hardened cutting edges and points for longer life
- Supplied in a handy storage holder

Punches:		
Centre	Length: 150 mm	5 mm
Parallel	Length: 150 mm	3, 4, 5 mm
Flat cold chisels:		
150 mm		Width: 19 mm

Item ID: PCX05



SPRIAL WIRE PLASTIC COATED

- For securing tools when working at a height
- Locking wire with a spring clip hook at each end plus a fixing wire
- Plastic covered (3mm diameter) stainless steel spiral wire (1mm diameter) with a maximum load of 3 kilos
- Stretches from 430mm to 1.6 meters

Item ID: SSH01



ELASTIC STRAP

- For securing tools when working at a height
- Locking wire with a spring clip hook at each end plus a fixing wire
- High strength nylon webbing with an elastic inner core with a maximum load of 3 kilos
- Stretches from 750mm to 1.35 meters

Item ID: **SSH02**



ELASTIC STRAP

- For securing tools when working at a height
- Locking wire with a spring clip hook at each end plus a fixing wire
- High strength nylon webbing with an elastic inner core with a maximum load of 4.5 kilos
- Stretches from 800mm to 1.35 meters

Item ID: **SSH03**



ELASTIC STRAP

- For securing tools when working at a height
- Locking wire with a carabiner style hook at one end and an adjustable rope lock on the other
- High strength nylon webbing with an elastic inner core with a maximum load of 4.5 kilos
- Stretches from 860mm to 1.45 meters

Item ID: **SSH04**

Lens Colour	CE scale no.	Visible Light 380-780nm	General Features
	2-1.2 2C-1.2	90% (UV385)	<ul style="list-style-type: none"> ◇ General purpose that provides maximum visibility. ◇ Indoor lens, good for mechanical work, or dusk, dawn and night time activities. ◇ For shooting indoors when no contrast is needed. An excellent safety lens while hand loading.
	2-1.2	89% (UV385)	<ul style="list-style-type: none"> ◇ Maximum enhancement of contrast in low light environments i.e. warehouse ◇ Blocks out 87% of blue light with unparalleled level of detail definition & colour recognition ◇ Offers brighter view in early morning or late evening, on cloudy, foggy, or hazy days. ◇ Suitable for night shift workers, surface inspection and mechanical work ◇ Recommended for shooting and indoor racquet sports
	5-2.5	18% (UV385)	<ul style="list-style-type: none"> ◇ Transmits all colours at the same level. ◇ Protects eyes from excessive glare and high levels of hazardous visible light and ultraviolet radiation without distorting colour perception ◇ Ideal for outdoors, for use on bright days & bright sunlight, but does not enhance target. ◇ General purpose safety lens / the most popular tinted lens



SAFETY GLASSES

- Optically neutral lenses with anti-fog and anti-scratch resistance (HC/AF)
- Clear polycarbonate lenses
- Shaped to give a large panorama view and integrated side protection
- Suitable for work wear or for visitor protection wear
- In accordance with EN166 class 1FT

ITEM ID:	Lens	Scratch Resistant	Anti Fog
SG960	Clear	Y	Y

Item ID: **SG960**



SAFETY GLASSES

- Optically neutral lenses with anti-fog and anti-scratch resistance (HC/AF)
- Grey/smoke polycarbonate lenses for protection against bright lights
- Shaped to give a large panorama view and integrated side protection
- Suitable for work wear or for visitor protection wear
- In accordance with EN166 class 1FT and EN172

ITEM ID:	Lens	Scratch Resistant	Anti Fog
SG960G	Grey/Smoke	Y	Y

Item ID: **SG960G**



SAFETY GLASSES

- Optically neutral lenses with anti-fog and anti-scratch resistance (HC/AF)
- Yellow polycarbonate lenses for protection in low light environments
- Shaped to give a large panorama view and integrated side protection
- Suitable for work wear or for visitor protection wear
- In accordance with EN166 class 1FT and EN170

ITEM ID:	Lens	Scratch Resistant	Anti Fog
SG960Y	Amber	Y	Y

Item ID: **SG960Y**



SAFETY GLASSES

- Optically neutral lenses with anti-scratch resistance (HC)
- Clear polycarbonate lenses
- Shaped to give a large panorama view and integrated side protection
- Suitable for work wear or for visitor protection wear
- In accordance with EN166 class 1FT

ITEM ID:	Lens	Scratch Resistant	Anti Fog
SG960A	Clear	Y	-

Item ID: **SG960A**



SAFETY GLASSES SPORT STYLE

- Sports inspired design for a more stylish pair of protective glasses
- Optically neutral lenses with anti-fog and anti-scratch resistance (HC/AF)
- Soft bridge nose and side pieces for a more comfortable fit
- Clear polycarbonate lenses
- Shaped to give a large panorama view and integrated side protection
- Suitable for work wear or for visitor protection wear
- In accordance with EN166 class 1FT

ITEM ID:	Lens	Scratch Resistant	Anti Fog
SG713	Clear	Y	Y

Item ID: **SG713**



SAFETY GLASSES SPORT STYLE

- Sports inspired design for a more stylish pair of protective glasses
- Optically neutral lenses with anti-fog and anti-scratch resistance (HC/AF)
- Soft bridge nose and side pieces for a more comfortable fit
- Grey/smoke polycarbonate lenses for protection against bright lights
- Shaped to give a large panorama view and integrated side protection
- Suitable for work wear or for visitor protection wear
- In accordance with EN166 class 1FT and EN172

ITEM ID:	Lens	Scratch Resistant	Anti Fog
SG713G	Grey/Smoke	Y	Y

Item ID: **SG713G**



SUN GLASSES

- Black frames with straight arms
- Tinted glasses to protect against sunlight and bright lights
- Light and comfortable work wear glasses that give stylish protection
- Impact resistant with high optical clarity
- Conform to EN166, AS/NZS1067

ITEM ID:	Style	Arm Type
P-SG02	Black/Grey Frames	Straight

Item ID: **P-SG02**



SUN GLASSES

- Red frames with straight arms
- Tinted glasses to protect against sunlight and bright lights
- Light and comfortable work wear glasses that give stylish protection
- Impact resistant with high optical clarity
- Conform to EN166, AS/NZS1067

ITEM ID:	Style	Arm Type
P-SG01	Red Frames	Straight

Item ID: **P-SG01**



SUN GLASSES

- Black frames with curved arms
- Mirror effect glasses to protect against sunlight and bright lights
- Light and comfortable work wear glasses that give stylish protection
- Impact resistant with high optical clarity
- Conform to EN166, AS/NZS1067

ITEM ID:	Style	Arm Type
P-SG03	Black Frames	Curved

Item ID: **P-SG03**

AIR TOOLS

ESSENTIAL FOR ANY WORKSHOP

Air is a powerful and versatile resource that can help you get the job done quickly! If you need to cut through steel or machine-tighten a bolt, you will need a certain amount of torque. Choosing a tool for its convenience or cost really won't do any good if it isn't strong enough to get the job done. This range of air tools pack a real punch and have been developed to exceed the demands of a professional auto workshop.





3/8"

3/8" AIR RATCHET

- Reversible for tightening or loosening
- Designed for working in confined areas
- High torque forward and reverse action
- Simple single clutch operation for greater control
- Metal "squeeze action" trigger for easier use
- Handle design insulates against cold air and vibration

SPECIFICATION:		
Square drive	inch	3/8"
Bolt capacity	mm	M10
Free speed	rpm	220
Forward/reverse torque	Nm	41
Forward/reverse torque	ft-lb	30
Sound level *	dB	88
Vibration **	m/s ²	10
Minimum hose size	inch	3/8"
Air inlet	inch	1/4"
Air consumption at 100% int.	l/min	90.6
Air consumption at 100% int.	cfm	3.2
Air consumption at 15% int.	l/min	14
Air consumption at 15% int.	cfm	0.5
Length	mm	173.9
Weight	kg	0.6

* A weighted sound pressure level at work station in accordance with EN ISO 15744

** Vibration value according to EN ISO 28927-2

Item ID: **ARRM38**



1/2"

1/2" AIR RATCHET

- Reversible for tightening or loosening
- Designed for working in confined areas
- High torque forward and reverse action
- Simple single clutch operation for greater control
- Metal "squeeze action" trigger for easier use
- Handle design insulates against cold air and vibration

SPECIFICATION:		
Square drive	inch	1/2"
Bolt capacity	mm	M13
Free speed	rpm	160
Forward/reverse torque	Nm	95
Forward/reverse torque	ft-lb	70
Sound level *	dB	92
Vibration **	m/s ²	6
Minimum hose size	inch	3/8"
Air inlet	inch	1/4"
Air consumption at 100% int.	l/min	113.2
Air consumption at 100% int.	cfm	4
Air consumption at 15% int.	l/min	17
Air consumption at 15% int.	cfm	0.6
Length	mm	277
Weight	kg	1.3

* A weighted sound pressure level at work station in accordance with EN ISO 15744

** Vibration value according to EN ISO 28927-2

Item ID: **ARR12**



1/2"

MINI AIR IMPACT WRENCH

- Three forward steps up to 680Nm
- Compact and lightweight for use in confined spaces
- Extra high torque capacity for the size and weight
- Jumbo clutch mechanism
- Reversible for tightening or loosening
- Forward/reverse button for one handed operation
- Extra lightweight composite housing
- Sound absorbent housing for noise reduction

SPECIFICATION:		
Square drive	inch	1/2"
Bolt capacity	mm	M16
Free speed	rpm	8,000
Max torque (3 steps)	Nm	285/380/680
Max torque (3 steps)	ft-lb	210/280/501
Max reverse torque	Nm	770
Max reverse torque	ft-lb	568
Hammer mechanism	type	Jumbo hammer
Sound level *	dB	102
Vibration **	m/s ²	7.5
Minimum hose size	inch	3/8"
Air inlet	inch	1/4"
Air consumption at 100% int.	l/min	121
Air consumption at 100% int.	cfm	4.23
Air consumption at 15% int.	l/min	18
Air consumption at 15% int.	cfm	0.6
Length	mm	113
Weight	kg	1.3

* A weighted sound pressure level at work station in accordance with EN ISO 15744

** Vibration value according to EN ISO 28927-2

Item ID: **ARWM12M**



TT SERIES

2

13 Pieces

1/2"

1/2" AIR IMPACT WRENCH SET TT2 13 PIECES

- Compact and lightweight 1/2" drive impact wrench
- For use in confined spaces
- Supplied with stubby 1/2" drive impact sockets
- Supplied in the unique TengTools tray to be used within the Get Organised System

Impact Sockets - 1/2" Stubby:		
10, 12, 13, 14, 15, 16, 17, 18, 19, 21, 22, 24 mm		
Compact Impact Wrench Specification:		
Square drive	1/2"	
Bolt capacity	mm	M16
Free speed	rpm	8,000
Max torque (3 steps)	Nm	285/380/680
Max torque (3 steps)	ft-lb	210/280/501
Max reverse torque	Nm	770
Max reverse torque	ft-lb	568
Hammer mechanism	type	Jumbo hammer
Sound level *	dB	102
Vibration **	m/s ²	7.5
Minimum hose size	inch	3/8"
Air inlet	inch	1/4"
Air consumption at 100% int.	l/min	121
Air consumption at 100% int.	cfm	4.23
Air consumption at 15% int.	l/min	18
Air consumption at 15% int.	cfm	0.6
Length	mm	113
Weight	kg	1.3

Item ID: **TTDAWM13M**



3/8"

3/8" DRIVE AIR IMPACT WRENCH

- Three forward steps up to 465Nm
- Reversible for tightening or loosening
- Forward/reverse button for one handed operation
- High torque action
- Hard wearing, lightweight aluminium housing
- Twin hammer mechanism for increased torque and reduced vibration
- Handle design insulates against cold air and vibration

SPECIFICATION:		
Square drive	inch	3/8"
Bolt capacity	mm	M13
Free speed	rpm	9,000
Max torque (3 steps)	Nm	115/285/465
Max torque (3 steps)	ft-lb	85/210/342
Max reverse torque	Nm	490
Max reverse torque	ft-lb	361
Hammer mechanism	type	Twin hammer
Sound level *	dB	95.4
Vibration **	m/s ²	4.96
Minimum hose size	inch	3/8"
Air inlet	inch	1/4"
Air consumption at 100% int.	l/min	105
Air consumption at 100% int.	cfm	3.7
Air consumption at 15% int.	l/min	16
Air consumption at 15% int.	cfm	0.6
Length	mm	159.4
Weight	kg	1.5

* A weighted sound pressure level at work station in accordance with EN ISO 15744

** Vibration value according to EN ISO 28927-2

Item ID: **ARWM38**



1/2"

1/2" DRIVE AIR IMPACT WRENCH

- Three forward steps up to 930Nm
- Reversible for tightening or loosening
- Forward/reverse button for one handed operation
- High torque action
- Hard wearing, lightweight aluminium housing
- Twin hammer mechanism for increased torque and reduced vibration
- Handle design insulates against cold air and vibration

SPECIFICATION:		
Square drive	inch	1/2"
Bolt capacity	mm	M16
Free speed	rpm	6,800
Max torque (3 steps)	Nm	385/530/930
Max torque (3 steps)	ft-lb	285/390/685
Max reverse torque	Nm	950
Max reverse torque	ft-lb	700
Hammer mechanism	type	Twin hammer
Sound level *	dB	92.5
Vibration **	m/s ²	22.45
Minimum hose size	inch	3/8"
Air inlet	inch	1/4"
Air consumption at 100% int.	l/min	162
Air consumption at 100% int.	cfm	5.3
Air consumption at 15% int.	l/min	24.3
Air consumption at 15% int.	cfm	0.8
Length	mm	183.1
Weight	kg	2.5

* A weighted sound pressure level at work station in accordance with EN ISO 15744

** Vibration value according to EN ISO 28927-2

Item ID: **ARWM12**



3/4"

3/4" AIR IMPACT WRENCH

- Three forward steps up to 1,790Nm
- Reversible for tightening or loosening
- Forward/reverse button for one handed operation
- High torque action
- Hard wearing, lightweight aluminium housing
- Twin hammer mechanism for increased torque and reduced vibration
- Handle design insulates against cold air and vibration

SPECIFICATION:		
Square drive	inch	3/4"
Bolt capacity	mm	M32
Free speed	rpm	5,000
Max torque (3 steps)	Nm	1,084/1,300/1,790
Max torque (3 steps)	ft-lb	800/960/1,320
Max reverse torque	Nm	1,830
Max reverse torque	ft-lb	1,349
Hammer mechanism	type	Twin hammer
Sound level *	dB	95.1
Vibration **	m/s ²	11.88
Minimum hose size	inch	1/2"
Air inlet	inch	3/8"
Air consumption at 100% int.	l/min	181
Air consumption at 100% int.	cfm	6.4
Air consumption at 15% int.	l/min	27.2
Air consumption at 15% int.	cfm	1
Length	mm	218.8
Weight	kg	3.9

* A weighted sound pressure level at work station in accordance with EN ISO 15744

** Vibration value according to EN ISO 28927-2

Item ID: **ARWM34**



3/8"

3/8" DRIVE COMPOSITE AIR IMPACT WRENCH

- Three forward steps up to 450Nm
- Reversible for tightening or loosening
- Forward/reverse button for one handed operation
- High torque action
- Extra lightweight composite housing
- Sound absorbent housing for noise reduction
- Twin hammer mechanism for increased torque and reduced vibration
- Handle design insulates against cold air and vibration

SPECIFICATION:		
Square drive	inch	3/8"
Bolt capacity	mm	M13
Free speed	rpm	9,000
Max torque (3 steps)	Nm	163/244/450
Max torque (3 steps)	ft-lb	120/180/331
Max reverse torque	Nm	470
Max reverse torque	ft-lb	346
Hammer mechanism	type	Twin hammer
Sound level *	dB	94
Vibration **	m/s ²	3.8
Minimum hose size	inch	3/8"
Air inlet	inch	1/4"
Air consumption at 100% int.	l/min	128
Air consumption at 100% int.	cfm	4.5
Air consumption at 15% int.	l/min	19
Air consumption at 15% int.	cfm	0.7
Length	mm	161
Weight	kg	1.3

* A weighted sound pressure level at work station in accordance with EN ISO 15744

** Vibration value according to EN ISO 28927-2

Item ID: **ARWC38**



1/2"

1/2" DRIVE COMPOSITE AIR IMPACT WRENCH

- Three forward steps up to 930Nm
- Reversible for tightening or loosening
- Forward/reverse button for one handed operation
- High torque action
- Extra lightweight composite housing
- Sound absorbent housing for noise reduction
- Twin hammer mechanism for increased torque, greater reliability and reduced vibration
- Handle design insulates against cold air and vibration

SPECIFICATION:		
Square drive	inch	1/2"
Bolt capacity	mm	M16
Free speed	rpm	6,800
Max torque (3 steps)	Nm	258/461/930
Max torque (3 steps)	ft-lb	190/340/685
Max reverse torque	Nm	960
Max reverse torque	ft-lb	708
Hammer mechanism	type	Twin hammer
Sound level *	dB	96
Vibration **	m/s ²	3.6
Minimum hose size	inch	3/8"
Air inlet	inch	1/4"
Air consumption at 100% int.	l/min	144
Air consumption at 100% int.	cfm	5.1
Air consumption at 15% int.	l/min	22
Air consumption at 15% int.	cfm	0.8
Length	mm	186
Weight	kg	2

* A weighted sound pressure level at work station in accordance with EN ISO 15744
 ** Vibration value according to EN ISO 28927-2

Item ID: **ARWC12**



3/4"

3/4" DRIVE COMPOSITE AIR IMPACT WRENCH

- Three forward steps up to 1,790Nm
- Reversible for tightening or loosening
- Forward/reverse button for one handed operation
- High torque action
- Extra lightweight composite housing
- Sound absorbent housing for noise reduction
- Twin hammer mechanism for increased torque and reduced vibration
- Handle design insulates against cold air and vibration

SPECIFICATION:		
Square drive	inch	3/4"
Bolt capacity	mm	M32
Free speed	rpm	6,000
Max torque (3 steps)	Nm	1,084/1,300/1,790
Max torque (3 steps)	ft-lb	800/960/1,320
Max reverse torque	Nm	1,830
Max reverse torque	ft-lb	1,349
Hammer mechanism	type	Twin hammer
Sound level *	dB	100
Vibration **	m/s ²	19
Minimum hose size	inch	1/2"
Air inlet	inch	3/8"
Air consumption at 100% int.	l/min	195
Air consumption at 100% int.	cfm	6.9
Air consumption at 15% int.	l/min	29
Air consumption at 15% int.	cfm	1
Length	mm	218.8
Weight	kg	3.5

* A weighted sound pressure level at work station in accordance with EN ISO 15744
 ** Vibration value according to EN ISO 28927-2

Item ID: **ARWC34**



1"

STRAIGHT AIR IMPACT WRENCH

- Four forward steps up to 2,712Nm
- Extra lightweight composite housing
- Straight design with long anvil
- Reversible for tightening or loosening
- Forward/reverse button for one handed operation
- High torque action
- Sound absorbent housing for noise reduction
- Twin hammer mechanism for increased torque and reduced vibration
- Handle design insulates against cold air and vibration

SPECIFICATION:		
Square drive	inch	1"
Bolt capacity	mm	M36
Free speed	rpm	5,500
Max torque (4 steps)	Nm	976/1,300/1,735/2,712
Max torque (4 steps)	ft-lb	720/960/1,280/2,000
Max reverse torque	Nm	2,730
Max reverse torque	ft-lb	2,013
Hammer mechanism	type	Twin hammer
Sound level *	dB	105
Vibration **	m/s ²	12.88
Minimum hose size	inch	3/4"
Air inlet	inch	1/2"
Air consumption at 100% int.	l/min	271
Air consumption at 100% int.	cfm	9.6
Air consumption at 15% int.	l/min	41
Air consumption at 15% int.	cfm	1.4
Length	mm	504.5
Weight	kg	8.1

* A weighted sound pressure level at work station in accordance with EN ISO 15744
 ** Vibration value according to EN ISO 28927-2

Item ID: **ARWM11S**



AIR DRILL 10MM CHUCK

- Air drill with 10mm chuck
- Pistol style for easier use
- Suitable for left or right handed use
- Simple to use thumb switch lever for switching between forward and reverse
- Quick chuck mechanism for fast and easy changing of drill bits
- Composite grip protects against cold air

SPECIFICATION:		
Chuck size	mm	10
Free speed	rpm	1,800
Minimum hose size	inch	3/8"
Air inlet	inch	1/4"
Sound level *	dB	88
Vibration **	m/s ²	3
Air consumption at 100% int.	l/min	121
Air consumption at 100% int.	cfm	4
Air consumption at 15% int.	l/min	18
Air consumption at 15% int.	cfm	0.7
Length	mm	206.2
Weight	kg	1.2

* A weighted sound pressure level at work station in accordance with EN ISO 15744
 ** Vibration value according to EN ISO 28927-2

Item ID: **ARD10**

**AIR DRILL 13MM CHUCK**

- Air drill with 13mm chuck
- Pistol style for easier use
- Supplied with a support handle
- Suitable for left or right handed use
- Simple to use thumb switch lever for switching between forward and reverse
- Quick chuck mechanism for fast and easy changing of drill bits
- Composite grip protects against cold air

SPECIFICATION:		
Chuck size	mm	13
Free speed	rpm	450
Minimum hose size	inch	3/8"
Air inlet	inch	1/4"
Sound level *	dB	89
Vibration **	m/s ²	2
Air consumption at 100% int.	l/min	140
Air consumption at 100% int.	cfm	5
Air consumption at 15% int.	l/min	21
Air consumption at 15% int.	cfm	0.8
Length	mm	249.5
Weight	kg	1.9

* A weighted sound pressure level at work station in accordance with EN ISO 15744

** Vibration value according to EN ISO 28927-2

Item ID: **ARD13**

**245MM AIR SAW**

- Air Saw with key hole saw function
- Small and easy to operate with low vibration and high cutting capacity
- Suitable for cutting steel plate, aluminium, copper, plastic, wood, etc.
- Compatible with standard saw blades
- Straight design with lever arm throttle for easier use
- Handle design insulates against cold air and vibration

SPECIFICATION:		
Stroke length	mm	10
Strokes per minute	bpm	9,000
Cutting capacity – steel	mm	3
Cutting capacity – aluminium	mm	3
Cutting capacity – wood	mm	4
Sound level *	dB	84
Vibration **	m/s ²	<2.4
Minimum hose size	inch	3/8"
Air inlet	inch	1/4"
Air consumption at 100% int.	l/min	31
Air consumption at 100% int.	cfm	1.08
Air consumption at 15% int.	l/min	4.7
Air consumption at 15% int.	cfm	0.2
Length	mm	245.1
Weight	kg	0.7

* A weighted sound pressure level at work station in accordance with EN ISO 15744

** Vibration value according to EN ISO 28927-2

Item ID: **ARS01**

**170MM AIR SAW**

- Air Saw with key hole saw function
- Small and easy to operate with low vibration and high cutting capacity
- Suitable for cutting steel plate, aluminium, copper, plastic, wood, etc.
- Compatible with standard saw blades
- Straight design with lever arm throttle for easier use
- Handle design insulates against cold air and vibration

SPECIFICATION:		
Stroke length	mm	10
Strokes per minute	bpm	9,000
Cutting capacity – steel	mm	3
Cutting capacity – aluminium	mm	3.4
Cutting capacity – wood	mm	4
Sound level *	dB	84.4
Vibration **	m/s ²	5.26
Minimum hose size	inch	3/8"
Air inlet	inch	1/4"
Air consumption at 100% int.	l/min	22.94
Air consumption at 100% int.	cfm	0.81
Air consumption at 40% int.	l/min	9.18
Air consumption at 40% int.	cfm	0.32
Length	mm	170
Weight	kg	0.45

* A weighted sound pressure level at work station in accordance with EN ISO 15744

** Vibration value according to EN ISO 28927-2

Item ID: **ARS02**

**AIR CUT OFF TOOL**

- For use with 3" / 76mm cut off discs
- Hole size is 3/8" / 10mm
- Reversible direction for better control of spark direction
- Suitable for left or right handed users
- Ergonomically designed trigger with safety throttle and speed control
- Handle design insulates against cold air and vibration
- Air exhaust in the handle to protect against cold air
- Safety guard above the cut off disc

SPECIFICATION:		
For cutting discs	mm	76x10mm, 3"x3/8"
Speed	rpm	18,000
Sound Level *	dB	98
Vibration **	m/s ²	2.3
Minimum hose size	inch	3/8"
Connection thread	inch	1/4"
Air consumption at 100% int.	l/min	113
Air consumption at 100% int.	cfm	4
Air consumption at 40% int.	l/min	45
Air consumption at 40% int.	cfm	1.6
Weight	kg	0.9

* A weighted sound pressure level at work station in accordance with EN ISO 15744

** Vibration value according to EN ISO 28927-2

Item ID: **ARC80**



STRAIGHT AIR DIE GRINDER

- Composite grip for added comfort
- Air exhaust in the handle to protect against cold air
- Silencer for noise reduction and quieter operation
- Safety throttle lever to avoid accidental operation

SPECIFICATION:		
Angle		Straight
Collet	mm	6
Free speed	rpm	25,000
Sound level *	dB(A)	82
Vibration **	m/s ²	5
Minimum hose size	inch	3/8
Air inlet	inch	1/4
Air consumption at 100% int.	l/min	113
Air consumption at 15% int.	l/min	17
Air consumption at 100% int.	cfm	4
Air consumption at 15% int.	cfm	0.6
Length	mm	161
Weight	g	400

* A weighted sound pressure level at work station in accordance with EN ISO 15744

** Vibration value according to EN ISO 28927-2

Item ID: **ARG01**



ANGLED AIR DIE GRINDER

- Angled at 90° for use from above
- Air exhaust in the handle to protect against cold air
- Silencer for noise reduction and quieter operation
- Safety throttle lever to avoid accidental operation

SPECIFICATION:		
Angle		90°
Collet	mm	6
Free speed	rpm	25,000
Sound level *	dB(A)	82
Vibration **	m/s ²	5
Minimum hose size	inch	3/8
Air inlet	inch	1/4
Air consumption at 100% int.	l/min	113
Air consumption at 15% int.	l/min	17
Air consumption at 100% int.	cfm	4
Air consumption at 15% int.	cfm	0.6
Length	mm	165
Weight	g	400

* A weighted sound pressure level at work station in accordance with EN ISO 15744

** Vibration value according to EN ISO 28927-2

Item ID: **ARG02**



AIR ANGLE GRINDER

- For use with 5" (125mm) grinding wheels
- Fully adjustable guard with 9 different positions
- Side handle dampens against vibration for more comfortable use
- M14 flange washer and spindle locking for easier change of wheels
- Ergonomically designed trigger with safety throttle and speed control
- Handle design insulates against cold air and vibration

SPECIFICATION:		
For grinding disc	mm	125 x 22
Spindle thread	mm	M14
Rotating speed	rpm	12,000
Sound level *	dB	90.2
Sound power level	dB	101.2
Vibration **	m/s ²	6
Measurement uncertainty (Standard)	m/s ²	1.06
Min. hose size	inch	3/8"
Air inlet	inch	1/4"
Air consumption at 100% int.	l/min	113
Air consumption at 50% int.	l/min	56.5
Air consumption at 100% int.	cfm	4
Air consumption at 50% int.	cfm	2
Power	W	670
Weight	kg	2

* A weighted sound pressure level at work station in accordance with EN ISO 15744

** Vibration value according to EN ISO 28927-2

Item ID: **ARAG125**



AIR BELT SANDER

- For use with 6 and 10mm wide abrasive belts
- Fully adjustable grinding arm with 360° rotation
- Suitable for grinding metal, plastic or wood
- Ergonomically designed trigger with safety throttle and speed control
- Handle design insulates against cold air and vibration
- Supplied with grinding arms for 6mm and 10mm wide 330mm length belts
- 4 belts included

SPECIFICATION:		
For sanding belt	mm	6 x 330, 10 x 330
Free speed	rpm	20,000
Sound pressure level *	dB	86
Sound power level	dB	97
Vibration **	m/s ²	1
Measurement uncertainty (Standard)	m/s ²	1
Min. hose size	inch	3/8"
Air inlet	inch	1/4"
Air consumption at 100% int.	l/min	119
Air consumption at 50% int.	l/min	59.5
Air consumption at 100% int.	cfm	4.2
Air consumption at 50% int.	cfm	2.1
Length	mm	331
Weight	kg	0.85

* A weighted sound pressure level at work station in accordance with EN ISO 15744

** Vibration value according to EN ISO 28927-2

Item ID: **ARBS10**



AIR NEEDLE SCALER

- For cleaning and descaling work
- Straight design with lever arm throttle
- Air exhaust in the handle to protect against cold air
- Supplied complete with needle equipment
- For use with 3mm diameter, 126mm length needles

SPECIFICATION:		
Stroke speed	bpm	4,000
No. of needles	pcs	12
Needle stroke	mm	24
Needle diameter x length (AXB)	mm	3 x 126
Sound pressure level *	dB	88.7
Vibration **	m/s ²	3.8
Min. hose size	inch	3/8"
Air inlet	inch	1/4"
Air consumption at 100% int.	l/min	170
Air consumption at 20% int.	l/min	34
Air consumption at 100% int.	cfm	6
Air consumption at 20% int.	cfm	1.2
Total length	mm	310
Weight	kg	1.14

* A weighted sound pressure level at work station in accordance with EN ISO 15744
 ** Vibration value according to EN ISO 28927-2

Item ID: **ARN12**



AIR RIVET GUN

- For use with 2.4, 3.0, 3.2, 4.0, 4.8 or 5.0mm rivets
- For use with aluminium, copper, steel and stainless steel blind rivets
- Ergonomically designed to reduce fatigue from vibration
- Patented rivet size hole gauge to ensure the correct size rivet and nose piece are selected
- Spent mandrel container automatically collects spent mandrels
- Complete with hanging bracket for easier storage

SPECIFICATION:		
Traction force	N	9,000
Compressed air pressure stroke	mm	16
Sound pressure level *	dB	86
Sound power level	dB	97
Vibration **	m/s ²	3
Air inlet	inch	1/4" PT-19
Min. hose size	inch	3/8"
Working Temperature	°C	0-40
Air consumption at 100% int.	l/rivet	2.1
Weight	g	1710

* A weighted sound pressure level at work station in accordance with EN ISO 15744
 ** Vibration value according to EN ISO 28927-2

Item ID: **ARRG80**

SERVICE KITS FOR AIR RIVET GUN

ITEM ID:	Description
ARRG80-1RK	Nosepieces (4 Pieces)
ARRG80-3RK	Jaw Case Assembly



AIR ENGRAVING PEN

- With hardened metal stylus
- Suitable for use on plastic as well as metals including hardened steel
- Steel body with knurled grip and on/off control
- Supplied with 1.5 meter connection cable with 360° swivelling air inlet

SPECIFICATION:		
Working pressure	bar	6
Stroke speed	bpm	13,000
Sound Level *	dB	78
Sound power level	dB	90
Vibration **	m/s ²	3
Air inlet	inch	1/4"
Air consumption at 100% int.	l/min	30
Air consumption at 50% int.	l/min	15
Air consumption at 100% int.	cfm	1.1
Air consumption at 50% int.	cfm	0.6
Weight	kg	0.22

* A weighted sound pressure level at work station in accordance with EN ISO 15744
 ** Vibration value according to EN ISO 28927-2

Item ID: **AREP25**



AIR BLOW GUN

- Pistol grip with 100mm nozzle and 1/4" air inlet
- Suitable for left or right handed use
- Low effort trigger mechanism for easier operation
- Metal thread insert for reliability
- Hole in the handle for use with fall protection wire

SPECIFICATION:		
Nozzle length	mm	100
Air inlet	inch	1/4"
Length	mm	212
Weight	g	106

Item ID: **ARB01**



AIR BLOW GUN

- Pistol grip with 270mm nozzle and 1/4" air inlet
- Suitable for left or right handed use
- Low effort trigger mechanism for easier operation
- Metal thread insert for reliability
- Hole in the handle for use with fall protection wire

SPECIFICATION:		
Nozzle length	mm	270
Air inlet	inch	1/4"
Length	mm	360
Weight	g	130

Item ID: **ARB02**



AIR BLOW GUN

- Relief slot conforms to OSHA - Occupational Safety and Health Administration safety standards
- Pistol grip with 100mm nozzle and 1/4" air inlet
- Suitable for left or right handed use
- Low effort trigger mechanism for easier operation
- Metal thread insert for reliability
- Hole in the handle for use with fall protection wire

SPECIFICATION:		
Nozzle length	mm	100
Air inlet	inch	1/4"
Length	mm	212
Weight	g	160

Item ID: **ARB03**

125° Hook Tool	462	Aluminium Spirit Levels	459	C Clamp Power Grip Pliers	419
2 Arm Quick Action Universal Puller Set	477	Aluminium Spirt Level	459	C Clamp Power Grip Pliers	420
2 Arm Quick Action Universal Pullers	476	Aluminium Try Squares	457	Cable Tie Gun	483
2 Arm Universal Puller Set	477	Angled Ratcheting Bits Driver Set	371	Cantilever Tool Box	90
2 Arm Universal Pullers	476	Angled Ratcheting Bits Driver Set	137, 372	Carbon Fibre Claw Hammer	501
2 In 1 Magnetic Pick Up And Pen	492	Angular Gauge	292	Carpenters Pliers	403
3 Arm Quick Action Universal Pullers	476	Anti Slip Combination Spanner Set	307	Carrying Case	89
3 Arm Universal Pullers	476	Anti Slip Combination Spanner Set	126, 306	Centre Punches	501
3 In 1 Inspection Tool	492	Anti Slip Combination Spanner Set	168, 306	Chain Pipe Cutter	486
35° Hook Tool	462	Anti Slip Combination Spanner Set	183, 307	Chain Pipe Wrench	487
37" Roller Cabinet	85	Anti Slip Combination Spanners	306	Chrome Molybdenum Ball Point Hex Keys	381
37" Stack Tool Kit	16-17	Assorted Key Set	396	Chrome Molybdenum Ball Point Hex Keys	382
37" Stack Tool Kit	34-35	Automatic Centre Punch	502	Chrome Molybdenum Ball Point Hex Keys	382
37" Top Box	77	Automotive Socket Set	148, 469	Circlip Plier Set	413
4 Piece Divider Set	93	Awl	461	Circlip Plier Set	141, 415
4" Gear Puller	475	Ball Joint Separator	468	Circlip Plier Set	141, 416
6mm/7mm Hose Clip Driver	463	Ball Pein Hammers	499	Circlip Plier Set	141, 417
7" Gear Puller	475	Ball Point Hex Key Set	384	Circlip Plier Set	142, 416
72 Teeth Ratchets	234	Ball Point Hex Key Set	385	Circlip Plier Set	142, 417
7mm Hose Clip Driver	463	Ball Point Hex Key Set	386	Circlip Pliers	413
8mm Hose Clip Driver	463	Ball Point Hex Keys	381	Circlip Pliers	414
9 Series - Tool Cabinet	84	Ball Point Hex Keys	382	Circlip Pliers	415
9" Crimping Plier And Wire Stripper	481	Ball Point Tx Key Set	393	Circuit Tester	483
9" Crimping Plier And Wire Stripper	482	Ball Point Tx Key Set	394	Clamping Power Grip Pliers	421
90° Hook Tool	461	Ball Point Tx Keys	391	Claw Hammer With Magnetic Nail Holder	501
Adaptors	240	Ball Point Tx Keys	392	Claw Hammers	500
Adjustable Tap Chuck	447	Barn Style Tool Box	91	Claw Pick Up Tool	491
Adjustable Wrench	326	Base Squares	456	Clip Rail Set	110
Adjustable Wrench	328	Bent Long Nose Pliers	405	Cold Chisels	502
Adjustable Wrench Service Kit	326	Bicycle Tool Kit	396, 471	Combination Pliers	404
Adjustable Wrench Service Kit	328	Bi-Directional Torque Wrenches	286	Combination Spanner And File Set	170
Adjustable Wrench Service Kit	329	Bi-Directional Torque Wrenches	289	Combination Spanner Set	169
Adjustable Wrench Set	131, 329	Bi-Flex Wrench	323	Combination Spanner Set	301
Adjustable Wrench Set	171, 329	Bit Adaptors For Sockets	361	Combination Spanner Set	302
AF Combination Spanners	299	Bit Holders	360	Combination Spanner Set	303
AF Ratcheting Combination Spanners	310	Bit Set	365	Combination Spanner Set	304
Air Angle Grinder	517	Bit Set	367	Combination Spanner Set	304
Air Belt Sander	517	Bit Socket Set	116, 204	Combination Spanner Set	305
Air Blow Gun	519	Bits Driver	369	Combination Spanner Set	126, 299
Air Cut Off Tool	515	Bits Driver	370	Combination Spanner Set	126, 300
Air Die Grinder Angled	516	Bits Driver Extension	361	Combination Spanner Set	127, 299
Air Die Grinder Straight	516	Bits Driver Set	370	Combination Spanner Set	127, 300
Air Drill	513	Bits Set	365	Combination Spanner Set	168, 300
Air Drill	514	Blank Key	98	Combination Spanner Set	169, 300
Air Engraving Pen	519	Body Working Dollies	472	Combination Spanner Set	183, 301
Air Impact Wrench	510	Body Working Hammer	473	Combination Square	457
Air Impact Wrench	511	Bodywork Hammer Set	149, 473	Composite Air Impact Wrench	511
Air Impact Wrench Set	153, 509	Bolt Cutter Replacement Jaws	402	Composite Air Impact Wrench	512
Air Needle Scaler	518	Bolt Cutters	402	Construction Impact Bit Set	365
Air Ratchet	508	Brackets For Middle Boxes	93	Coupler Adaptors	240, 361
Air Rivet Gun	518	Brackets For Top Boxes	93	Crimping Plier And Wire Stripper	482
Air Saw	514	Brake Cylinder Honing Tool	467	Crimping Plier Set	151, 482
Air Saw	515	Brake Pin Punch	467	Crimping Plier Set	151, 483
Aluminium Pipe Reamers	486	Brake Spring Washer Tool	467	Crow Foot Wrench Set	207, 256
		Brick Layers Masonry Hammer	501	Crow Foot Wrenches	256

Cutting Tool Set	145, 440	Drain Plug Keys	466	Flex Handle Service Kits	236, 238
Dead Blow Hammers	473	Drill Bit Set	446	Flex Handles	238
Deburring Tool	486	End Nippers	403	Flex Head Adaptor	240
Deburring Tool	487	Engine Cylinder Honing Tool	467	Flex Head Ratchets	235
Deep 6 Point Impact Sockets	269	Engineers Style Hammer	499	Flexible Head Ratchet Spanner Set	128, 315
Deep 6 Point Impact Sockets	272	Ev - Tool Cabinet	82	Flexible Head Ratchet Spanners	315
Deep 6 Point Impact Sockets	273	Eva Extra Wide Roller Cabinet Tool Kit	48-49	Flexible Led Light	494
Deep 6 Point Impact Sockets	276	Eva Portable Tool Kit	64	Flexible Light	495
Deep 6 Point Impact Sockets	277	Eva Portable Tool Kit	65	Flexible Spinner Handle	237
Deep 6 Point Impact Sockets	272, 469	Eva Roller Cabinet Tool Kit	50	Flip Reverse Ratchets	235
Deep 6 Point Impact Sockets	273, 469	Eva Roller Cabinet Tool Kit	51	Flush Cut Pliers	403
Deep 6 Point Impact Sockets	276, 469	Eva Roller Cabinet Tool Kit	52	Foam Monster Tool Kit	32-33
Deep 6 Point Impact Sockets	277, 469	Eva Roller Cabinet Tool Kit	53	Folding Mini Utility Knife	444
Deep 6 Point Metric Impact Socket	278	Eva Stack System Tool Kit	36	Folding Universal Utility Knife	444
Deep Af Sockets	245	Eva Stack System Tool Kit	37	Fully Ground Drill Bit	445
Deep Af Sockets	250	Eva Stack System Tool Kit	38-39	Fully Ground Drill Bit Set	145, 446
Deep Af Sockets	251	Eva Top Box Tool Kit	60	Gasket Scraper	461
Deep Impact Socket Set	230	Extendable Ratchet	236	General Tool Set	112
Deep Impact Socket Set	231	Extendable Ratchet Set	120, 219	General Tool Set	156
Deep Metric 12 Point Sockets	258	Extension Bars	239	General Tool Set	157
Deep Metric 6 Point Sockets	258	Extension Bars Set	119, 239	General Tool Set	158
Deep Metric Sockets	244	Extension Bars Set	161, 239	Grease Gun	475
Deep Metric Sockets	249	Extra Long 6 Point Metric Impact Socket	277	Groove Joint Pliers	406
Deep Metric Sockets	250	Extra Long 6 Point Metric Impact Socket	279	Gun Saw Set	442
Deep Thinwall Metric Impact Sockets	279	Extra Long Combination Spanner Set	309	Hacksaw & Knife Set	442
Dial Indicator With Measuring Stand	455	Extra Long Combination Spanners	308	Hacksaw Blade Holder	441
Die Chuck	447	Extra Long Double Ring Spanner Set	130, 317	Hand File - Flat	450
Die Handle	447	Extra Long Double Ring Spanner Set	171, 318	Hand File - Half Round	450
Digital Bi-Directional Torque Wrench	284	Extra Long Double Ring Spanners	317	Hand File - Round	450
Digital Bi-Directional Torque Wrench	287	Extra Long Hex Key Set	384	Hand File - Square	450
Digital Caliper	454	Extra Long Hex Keys	381	Hand File - Triangular	450
Digital Multimeter	484	Extra Long Hex Keys	381	Hand File Set	146, 451
Digital Torque Tester	294	Extra Wide Roller Cabinet Tool Kit	40-41	Hand File Set	187, 451
Digital Torque Testers	294	Extra Wide Roller Cabinet Tool Kit	42-43	Hand Rivet Gun	488
Disc Brake Pad Puller	468	Extra Wide Stack System	74	Hand Rivet Gun With Swivel Head	489
Double Ended Blades	340	Extra Wide Tool Cabinet	86	Handle For Interchangeable Blades	426
Double Ended Flat (Slotted) Bit	352	Extra Wide Tool Cabinet	87	Handle For Tool Cabinets	97
Double Ended Mini Screwdriver Blades	333	Extra Wide Top Box	78	Handles For Top & Middle Boxes	97
Double Ended Ph Bits	352	Extractor Set	150, 480	Heavy Duty Cable Cutter	401
Double Ended Pz Bits	354	F Clamps	498	Heavy Duty Cable Cutters	401
Double Ended Tx Bits	355	F Clamps	499	Heavy Duty Cutters	402
Double Ended Wheel Nut Sockets	470	Fast Action Clamps	499	Heavy Duty Insulated Side Cutting Plier	431
Double Flex Wrench Set	130, 322	Feeler Gauges	454	Heavy Duty Oil Filter Removal Tool	466
Double Flex Wrench Set	171, 322	Five Lock Set	98	Heavy Duty Ratchet	236
Double Flex Wrench Set	184, 323	Flare Nut Wrenches	323	Heavy Duty Ratchet Head	236
Double Flex Wrenches	322	Flaring Tool Set	149, 468	Heavy Duty Ratchets	235
Double Open Ended Spanner Set	321	Flat (Slotted) Bits	352	Heavy Duty Tool Set	67
Double Open Ended Spanner Set	130, 320	Flat (Slotted) Blade Insulated Screw-drivers	424	Heavy Duty Utility Knife	444
Double Open Ended Spanners	320	Flat Bit Sockets	246	Hex & Tx Bit Socket Set	119, 214
Double Ring Spanner Set	318	Flat Nose Pliers	405	Hex And Tx Wrench Set	139, 389
Double Ring Spanner Set	319	Flat Screwdriver	336	Hex Bit Impact Sockets	269
Double Ring Spanner Set	129, 317	Flat Screwdriver	336	Hex Bit Impact Sockets	273
Double Ring Spanner Set	171, 318	Flat Screwdriver	338	Hex Bit Impact Sockets	274
Double Ring Spanners	316	Flex Handle Service Kits	238	Hex Bit Impact Sockets	277

Cutting Tool Set	145, 440	Drain Plug Keys	466	Flex Handle Service Kits	236, 238
Dead Blow Hammers	473	Drill Bit Set	446	Flex Handles	238
Deburring Tool	486	End Nippers	403	Flex Head Adaptor	240
Deburring Tool	487	Engine Cylinder Honing Tool	467	Flex Head Ratchets	235
Deep 6 Point Impact Sockets	269	Engineers Style Hammer	499	Flexible Head Ratchet Spanner Set	128, 315
Deep 6 Point Impact Sockets	272	Ev - Tool Cabinet	82	Flexible Head Ratchet Spanners	315
Deep 6 Point Impact Sockets	273	Eva Extra Wide Roller Cabinet Tool Kit	48-49	Flexible Led Light	494
Deep 6 Point Impact Sockets	276	Eva Portable Tool Kit	64	Flexible Light	495
Deep 6 Point Impact Sockets	277	Eva Portable Tool Kit	65	Flexible Spinner Handle	237
Deep 6 Point Impact Sockets	272, 469	Eva Roller Cabinet Tool Kit	50	Flip Reverse Ratchets	235
Deep 6 Point Impact Sockets	273, 469	Eva Roller Cabinet Tool Kit	51	Flush Cut Pliers	403
Deep 6 Point Impact Sockets	276, 469	Eva Roller Cabinet Tool Kit	52	Foam Monster Tool Kit	32-33
Deep 6 Point Impact Sockets	277, 469	Eva Roller Cabinet Tool Kit	53	Folding Mini Utility Knife	444
Deep 6 Point Metric Impact Socket	278	Eva Stack System Tool Kit	36	Folding Universal Utility Knife	444
Deep Af Sockets	245	Eva Stack System Tool Kit	37	Fully Ground Drill Bit	445
Deep Af Sockets	250	Eva Stack System Tool Kit	38-39	Fully Ground Drill Bit Set	145, 446
Deep Af Sockets	251	Eva Top Box Tool Kit	60	Gasket Scraper	461
Deep Impact Socket Set	230	Extendable Ratchet	236	General Tool Set	112
Deep Impact Socket Set	231	Extendable Ratchet Set	120, 219	General Tool Set	156
Deep Metric 12 Point Sockets	258	Extension Bars	239	General Tool Set	157
Deep Metric 6 Point Sockets	258	Extension Bars Set	119, 239	General Tool Set	158
Deep Metric Sockets	244	Extension Bars Set	161, 239	Grease Gun	475
Deep Metric Sockets	249	Extra Long 6 Point Metric Impact Socket	277	Groove Joint Pliers	406
Deep Metric Sockets	250	Extra Long 6 Point Metric Impact Socket	279	Gun Saw Set	442
Deep Thinwall Metric Impact Sockets	279	Extra Long Combination Spanner Set	309	Hacksaw & Knife Set	442
Dial Indicator With Measuring Stand	455	Extra Long Combination Spanners	308	Hacksaw Blade Holder	441
Die Chuck	447	Extra Long Double Ring Spanner Set	130, 317	Hand File - Flat	450
Die Handle	447	Extra Long Double Ring Spanner Set	171, 318	Hand File - Half Round	450
Digital Bi-Directional Torque Wrench	284	Extra Long Double Ring Spanners	317	Hand File - Round	450
Digital Bi-Directional Torque Wrench	287	Extra Long Hex Key Set	384	Hand File - Square	450
Digital Caliper	454	Extra Long Hex Keys	381	Hand File - Triangular	450
Digital Multimeter	484	Extra Long Hex Keys	381	Hand File Set	146, 451
Digital Torque Tester	294	Extra Wide Roller Cabinet Tool Kit	40-41	Hand File Set	187, 451
Digital Torque Testers	294	Extra Wide Roller Cabinet Tool Kit	42-43	Hand Rivet Gun	488
Disc Brake Pad Puller	468	Extra Wide Stack System	74	Hand Rivet Gun With Swivel Head	489
Double Ended Blades	340	Extra Wide Tool Cabinet	86	Handle For Interchangeable Blades	426
Double Ended Flat (Slotted) Bit	352	Extra Wide Tool Cabinet	87	Handle For Tool Cabinets	97
Double Ended Mini Screwdriver Blades	333	Extra Wide Top Box	78	Handles For Top & Middle Boxes	97
Double Ended Ph Bits	352	Extractor Set	150, 480	Heavy Duty Cable Cutter	401
Double Ended Pz Bits	354	F Clamps	498	Heavy Duty Cable Cutters	401
Double Ended Tx Bits	355	F Clamps	499	Heavy Duty Cutters	402
Double Ended Wheel Nut Sockets	470	Fast Action Clamps	499	Heavy Duty Insulated Side Cutting Plier	431
Double Flex Wrench Set	130, 322	Feeler Gauges	454	Heavy Duty Oil Filter Removal Tool	466
Double Flex Wrench Set	171, 322	Five Lock Set	98	Heavy Duty Ratchet	236
Double Flex Wrench Set	184, 323	Flare Nut Wrenches	323	Heavy Duty Ratchet Head	236
Double Flex Wrenches	322	Flaring Tool Set	149, 468	Heavy Duty Ratchets	235
Double Open Ended Spanner Set	321	Flat (Slotted) Bits	352	Heavy Duty Tool Set	67
Double Open Ended Spanner Set	130, 320	Flat (Slotted) Blade Insulated Screw-drivers	424	Heavy Duty Utility Knife	444
Double Open Ended Spanners	320	Flat Bit Sockets	246	Hex & Tx Bit Socket Set	119, 214
Double Ring Spanner Set	318	Flat Nose Pliers	405	Hex And Tx Wrench Set	139, 389
Double Ring Spanner Set	319	Flat Screwdriver	336	Hex Bit Impact Sockets	269
Double Ring Spanner Set	129, 317	Flat Screwdriver	336	Hex Bit Impact Sockets	273
Double Ring Spanner Set	171, 318	Flat Screwdriver	338	Hex Bit Impact Sockets	274
Double Ring Spanners	316	Flex Handle Service Kits	238	Hex Bit Impact Sockets	277

Hex Bit Socket Set	205	Impact Driver Bits	376	Intricate Cutting Scissors	440
Hex Bit Socket Set	206	Impact Driver Set	375	IPR - Tamper Proof Bit Set	362
Hex Bit Socket Set	216	Impact Driver Set	124, 377	Kneeling Pad	495
Hex Bit Socket Set	217	Impact Driver Set	376	Large Capacity Sv Top Box	77
Hex Bit Socket Set	118, 213	Impact Driver Set	124, 376	Large Capacity Top Box	76
Hex Bit Socket Set	118, 214	Impact Magnetic Bits Holder	360	Large Magnetic Bits Tray	496
Hex Bit Sockets	206	Impact Nut Setter Set	366	Large Magnetic Bits Tray	497
Hex Bit Sockets	252	Impact Nut Setter Set	369	Lazy Tongue Rivet Gun	489
Hex Bit Sockets	253	Impact Nut Setters	360	Led Head Lamp	494
Hex Bit Sockets	259	Impact Screw Extractors	477	Led Light Bar	103
Hex Bit Sockets	260	Impact Socket Accessory Set	121, 227	Led Torch	493
Hex Bit Sockets	264	Impact Socket Accessory Set	122, 227	Led Work Light	103
Hex Bits	357	Impact Socket Set	166	Long Arm Flexible Ratchet	235
Hex Bits	358	Impact Socket Set	224	Long Arm Ratchet	235
Hex Bits	359	Impact Socket Set	225	Long Blade Straight Cut Tin Snips	439
Hex Impact Bit Socket Set	123, 228	Impact Socket Set	226	Long Double Ring Spanner Set	184, 318
Hex Impact Screwdriver Bit	358	Impact Socket Set	121, 226	Long Handled Nutsert Gun	490
Hex Key Set	384	Impact Socket Set	122, 227	Long Handled Rivet Gun	489
Hex Key Set	386	Impact Socket Set	122, 228	Long Hex Bit Sockets	260
Hex Key Set	387	Impact Socket Set	123, 229	Long Nose Pliers	404
Hex Key Set	388	Impact Socket Set	124, 229	Long Reach Combination Spanner Set	127, 309
Hex Keys	380	Impact Socket Set	165, 229	Long Reach Combination Spanner Set	183, 309
Hex Keys	380	Impact Socket Set	165, 230	Long Reach Flexible Bits Driver	369
Hex Screwdrivers	339	Impact Tx Bit Set	366	Long Reach Pliers	406
Hex, Tx And Screwdriver Key Set	177, 390	Individual Dies	447	Long T-Bar Socket Set	149, 252
High Leverage Left/Straight Cut Tin Snips	439	Individual Taps	446	Long Tx Bit Sockets	261
High Leverage Right/Straight Cut Tin Snips	439	Industrial Quality Workbenches	99	Lump Hammer	500
High Leverage Straight Cut Tin Snips	439	Insert Adaptor Set	241	Machine Table Clamp Locking Pliers	421
Hinge Adjustment Wrench	499	Insert Adaptors	241	Magnetic Aluminium Spirit Levels	459
Hinge Adjustment Wrenches	499	Insert Ratchet Adaptors	290	Magnetic Angle Blocks	497
Hobby Knife Set	443	Inspection Set	152, 493	Magnetic Bits Tray	496
Hobby Knife With 18Mm Blade	443	Inspection Set	153, 493	Magnetic Bracelet	496
Hobby Knife With 9Mm Blade	442	Insulated Combination Pliers	431	Magnetic Charger	343
Hook & Pick Set	462	Insulated Extension Bar	434	Magnetic Plastic Bowl	497
Hook And Pick Set	147, 462	Insulated Long Nose Pliers	431	Magnetic Side Shelf	93
Hook And Pin Wrench Set	131, 326	Insulated Plier Set	144, 432	Magnetic Side Shelf	94
Hook On Bits Set	363	Insulated Plier Set	180, 432	Magnetic Tool Rail	96
Hook On Can Holder	103	Insulated Plier Set	186, 433	Magnifying Glass	495
Hook On Impact Bits Set	363	Insulated Ratchet	434	Measuring Tapes	458
Hook On Tool Holder	103	Insulated Screwdriver And Plier Set	433	Measuring Tool Set	147, 456
Hook On Trays	103	Insulated Screwdriver Set	429	Measuring Tool Set	181, 456
Hook Wrenches	326	Insulated Screwdriver Set	143, 427	Mechanics Creeper	496
Hooks For Side Plates And Panels	96, 103	Insulated Screwdriver Set	143, 428	Mechanics Socket Set	211
Hose Clamp Set	148, 463	Insulated Screwdriver Set	144, 427	Mechanics Starter Kit	58
Hose Clamps	463	Insulated Screwdriver Set	180, 428	Mechanics Starter Kit	59
Impact Accessories	267	Insulated Screwdriver Set	186, 429	Mechanics Stool	496
Impact Adaptor	360	Insulated Side Cutting Plier	431	Mega Bite Cable Cutters	401
Impact Bit Set	365	Insulated Socket Set	144, 435	Mega Bite Side Cutters	400
Impact Bit Set	366	Insulated Socket Set	181, 435	Mega Master Tool Kit	18-19
Impact Bit Set	367	Insulated Sockets	434	Mega Master Tool Kit	20-21
Impact Bit Set	368	Insulated Torque Screwdriver	430	Metric Combination Spanners	298
Impact Bit Set	375	Insulated Torque Screwdriver Set	144, 430	Micrometer	454
Impact Bit Set	138, 364	Insulated Torque Screwdriver Set	180, 430	Middle Box	78
Impact Bit Set	176, 364	Insulated Wire Stripping Pliers	432	Middle Box	79
		Interchangeable Blades	427	Midget Combination Spanner Set	126, 308

Mini Air Impact Wrench	509	PH Blade Insulated Screwdrivers	425	Pry Bar Set	150, 481
Mini Bent Nose Plier	411	PH Impact Screwdriver Bit	353	Pry Bar Set	182, 481
Mini Bits Ratchet	234, 362	PH Screwdriver	337	Pry Bars	480
Mini End Cutter	410	PH Screwdriver	337	P-Series Insert Torque Wrenches	290
Mini Flat Nose Plier	410	PH Screwdriver	338	P-Series Torque Wrench Set	125, 288
Mini Hacksaw	441	PH2G Bits	353	P-Series Torque Wrenches	284
Mini Hacksaw	441	PH2G Impact Screwdriver Bit	354	P-Series Torque Wrenches	287
Mini Long Nose Plier	410	Pin Wrenches	326	P-Series Torque Wrenches	289
Mini Needle Nose Plier	411	Pipe Cutter	484	Punch And Chisel Set	503
Mini Palm Ratchet	234	Pipe Cutter	485	Punch And Chisel Set	153, 502
Mini Pliers & Screwdriver Set	134, 333, 411	Pipe Cutter Set	151, 487	Punch And Chisel Set	182, 502
Mini Ratchet	234	Pipe Reamer	486	Punch And Chisel Set	187, 503
Mini Round Nose Plier	411	Pipe Wrenches	409	PZ Bit Sockets	246
Mini Screwdriver	332	Piston Ring Compressor	467	PZ Bits	354
Mini Screwdriver	334	Plastic Try Squares	457	PZ Blade Insulated Screwdrivers	425
Mini Screwdriver Set	333	Plier & Wrench Set	140, 408	PZ Impact Screwdriver Bit	355
Mini Screwdriver Set	334	Plier And Hammer Set	156	PZ Screwdriver	337
Mini Screwdrivers - Flat Tip	332	Plier Set	178	PZ Screwdriver	337
Mini Screwdrivers - Hex Tip	332	Plier Set	179	Quick Chuck Bits Driver Set	176, 374
Mini Screwdrivers - Ph Tip	332	Plier Set	409	Quick Clamps	498
Mini Screwdrivers - Tx Tip	332	Plier Set	139, 407	Quick Set Water Pump Pliers	406
Mini Side Cutter	410	Plier Set	140, 407	Quick Set Water Pump Pliers	407
Mini Starter Kit	69	Plier Set	140, 408	Quick Wrench Set	131, 325
Mini T-Handle Screwdrivers - Tx Tip	334	Plier Set	178, 408	Quick Wrenches	325
Mini Tool Box	90	Plier Set	186, 409	Ratchet & Accessories Set	116, 212
Mini Tx Screwdriver Set	333	Plus/Minus Blade Insulated Screwdrivers	426	Ratchet & Accessories Set	120, 219
Mini Tx T-Handle Screwdriver Set	334	Pocket Sized Double Ring Spanner	316	Ratchet & Accessories Set	161, 220
Mobile Trolleys	99	Portable Service Case	89	Ratchet Action Crimping Plier	481
Monster Mega Master Tool Kit	12-13	Portable Tool Kit	62	Ratchet Combination Spanners	314
Monster Mega Master Tool Kit	14-15	Portable Tool Kit	63	Ratchet Head & Bits Holder	234, 362
Multi Drive Spanner Repair Kits	324	Portable Tool Kit	64	Ratchet Service Kits	236
Needle File	449	Portable Tool Kit	68	Ratchet Spanner Set	312
Needle File Set	146, 450	Portable Tool Kit	69	Ratchet Spanner Set	314
Non Slip Mat	92	Portable Tool Panels	105	Ratchet Spanner Set	127, 311
Nut And T Handle Driver Set	177	Portable Work Station With Tools	104	Ratchet Spanner Set	128, 311
Nut Driver Set	134, 342	Power Bar	236	Ratchet Spanner Set	128, 315
Nut Drivers	342	Power Grip Plier Set	179	Ratchet Spanner Set	129, 313
Nut Setters	359	Power Grip Plier Set	419	Ratchet Spanner Set	170, 311
Nut Splitter Set	478	Power Grip Plier Set	142, 418	Ratchet Spanner Set	170, 313
Nutsert Gun	489	Power Grip Plier Set	142, 419	Ratchet Spanner Set	183, 313
Nutsert Gun Set	152, 491	Power Grip Pliers	417	Ratcheting Bits Driver Set	370
Off Set Straight/Left Tin Snips	439	Power Grip Pliers	418	Ratcheting Bits Driver Set	371
Off Set Straight/Right Tin Snips	438	Power Through Screwdriver	341	Ratcheting Combination Spanner	310
Oil Filter Removal Tool	465	Power Through Screwdriver Set	133, 341	Ratcheting Combination Spanners	312
Oil Filter Removal Tool	466	Power Through Screwdriver Set	175, 341	Ratcheting Multi Drive Ring Spanner Set	324
Oil Filter Remover Plier	418, 465	Power Through Screwdriver Set	185, 342	Ratcheting Multi Drive Ring Spanners	323
Oil Service Set	148, 466	Power Through Screwdrivers - Flat Tip	341	Ratcheting Offset Ring Spanner Set	131, 324
Open Ended Insert Spanner	291	Power Through Screwdrivers - Ph Tip	341	Ratcheting Offset Ring Spanners	324
Open Ended Insert Spanner	292	Pre Set Torque Wrenches	287	Ratcheting Offset Tx-E Wrench	325
Open Ended Slogging Wrenches	327	Professional Quality Hacksaw	440	Ratcheting Podger Wrenches	325
Parallel Pin Punch Set	503	Professional Quality Hacksaw	441	Regular 6 Point Impact Sockets	268
Parallel Pin Punches	501	Professional Quality Hacksaw	440, 441	Regular 6 Point Impact Sockets	270
PH Bit Sockets	246	Protective Glasses	506	Regular 6 Point Impact Sockets	271
PH Bits	353	Protective Wing Cover	471	Regular 6 Point Impact Sockets	275

Regular 6 Point Impact Sockets	276	Screw Clamps	498	Socket Adaptor Set	121, 241
Regular 6 Point Impact Sockets	278	Screw Extractor Set	478	Socket And Spanner Set	169
Regular 6 Point Metric Impact Sockets	279	Screw Extractor Set	448, 478	Socket Clip Rail Set	96
Regular AF Sockets	243	Screw Extractors	478	Socket Clip Rails	96
Regular AF Sockets	248	Screwdriver & Hex Key Set	174	Socket Clips	96
Regular AF Sockets	249	Screwdriver And Hex Key Set	175	Socket Set	161
Regular AF Sockets	257	Screwdriver Bit Set	136, 372	Socket Set	162
Regular AF Sockets	264	Screwdriver Bit Set	136, 373	Socket Set	163
Regular Impact Socket Set	230	Screwdriver Blade	340	Socket Set	164
Regular Impact Socket Set	231	Screwdriver Blade Set	133, 340	Socket Set	190
Regular Metric 12 Point Sockets	257	Screwdriver Blades	333	Socket Set	191
Regular Metric 6 Point Sockets	256	Screwdriver Blades	340	Socket Set	192
Regular Metric Sockets	242	Screwdriver Rack	184, 345	Socket Set	193
Regular Metric Sockets	247	Screwdriver Set	173	Socket Set	194
Regular Metric Sockets	248	Screwdriver Set	346	Socket Set	197
Regular Metric Sockets	257	Screwdriver Set	347	Socket Set	198
Regular Metric Sockets	263	Screwdriver Set	348	Socket Set	199
Regular Metric Sockets	265	Screwdriver Set	349	Socket Set	200
Replacement Combination Locks	98	Screwdriver Set	132, 343	Socket Set	205
Replacement Key Locks	98	Screwdriver Set	132, 344	Socket Set	208
Replacement Pipe Cutter Chain	486	Screwdriver Set	133, 343	Socket Set	209
Replacement Pins	326	Screwdriver Set	133, 344	Socket Set	210
Retaining Rings & Pins	267	Screwdriver Set	172, 344	Socket Set	215
RIBE & XZN Bit Socket Set	119, 215	Screwdriver Set	172, 345	Socket Set	216
RIBE Bit Sockets	207	Screwdriver Set	349, 429	Socket Set	218
RIBE Bit Sockets	218	Screwdriver Set With Pocket Clips	335	Socket Set	219
RIBE Bit Sockets	255	Screwdriver With Pocket Clip	334	Socket Set	221
RIBE Bit Sockets	262	Screwdriver With Pocket Clip	335	Socket Set	222
Ring Ended Insert Spanner	290	Screwdriver & Spanner Set	174	Socket Set	223
Ring Ended Insert Spanner	291	Scriber	491	Socket Set	113, 195
Ring Type Slogging Wrenches	327	Self Locking Pliers	412	Socket Set	114, 195
Rivet Gun Set	152, 490	Service Case	89	Socket Set	114, 203
Rivet Gun Set	182, 490	Service Case Tool Kit	66	Socket Set	115, 203
ROB Bits	359	Service Kits For Air Rivet Gun	518	Socket Set	115, 204
ROB Blade Insulated Screwdriver	426	Service Kits For Nut Splitters	478	Socket Set	116, 212
ROB Impact Screwdriver Bit	359	Service Kits For Stud Extractors	479	Socket Set	117, 212
ROB Screwdriver	340	Service Tool Set	113	Socket Set	117, 213
ROB Screwdriver	340	Sheet Metal Power Grip Pliers	421	Socket Set	118, 213
Roller Cabinet Cover	91	Shock Absorbing Claw Hammer	500	Socket Set	120, 220
Roller Cabinet Tool Kit	46	Side Cabinet	88	Socket Set	121, 220
Roller Cabinet Tool Kit	47	Side Cabinet Transport Trolley	97	Socket Set	159, 196
Roller Cabinet Tool Kit	44-45	Side Cupboard	88	Socket Set	160, 205
Rotating Pipe Cutters	486	Side Plate	95	Socket Set	160, 215
Rotating Spinner Handle	237	Side Table And Paper Roll Holder	94	Socket Set	162, 220
Round Nose Pliers	405	Side Table For Mounting A Vice	95	Socket Set	191, 366
S Shaped Hook Tool	461	Sliding Bevel	457	Socket Set	192, 367
Safety Glasses	504	Sliding T-Bars	241	Soft Face Hammer	500
Safety Glasses	505	Socket & Bits Set	134, 372	Spanner Ring	315
Safety Glasses	506	Socket & Bits Set	135, 373	Spanner Set	170
Safety Hand Grip	502	Socket & Bits Set	136, 374	Spare Blades	443
Safety Utility Knife	444	Socket & Bits Set	137, 374	Spare Blades	444
Safety Wire	503	Socket & Tool Set	201	Spare Blades	445
Safety Wire	504	Socket & Tool Set	202	Spare Heads For Cp52	481
Scissors	440	Socket & Tool Set	211	Spare Pipe Cutter Blades	484
Scraper Set	147, 462	Socket & Tool Set	222	Spare Pipe Cutter Blades	485

Spare Wheel Set	496	Telescopic Basin Tap Wrench	487	TPX Bit Socket Set	206
Spark Plug Boot Plier	464	Telescopic Inspection Mirror	492	TPX Bit Socket Set	217
Spark Plug Socket Set	148, 464	Telescopic Magnetic Pick Up Tool	492	TPX Bit Sockets	255
Spark Plug Socket Set	181, 464	Telescopic Magnifying Glass	492	TPX Bit Sockets	262
Spark Plug Sockets	464	Telescopic Wheel Wrenches	470	TPX Bits	357
Specialist Automotive Sockets	469	T-Handle Hex Key Set	185, 390	TPX Key	395
Speed Braces	238	Thread Cleaners	465	TPX Key Set	395
Spinner Handle	237	Thread Gauge	455	TPX Screwdriver	338
Stack System	72	Three Lock Set	98	TPX Screwdriver	338
Stack System	73	TJ Socket Set	190	Tweezers	412
Stack System Cover	92	TJ Socket Set	191	Twin/Triple Leg Pullers	475
Stack System Tool Kit	22-23	Tool Back Pack	91	TX Bit Impact Sockets	274
Stack System Tool Kit	24-25	Tool Bag	91	TX Bit Set	362
Stack System Tool Kit	26-27	Tool Box	90	TX Bit Socket Set	206
Stack System Tool Kit	28-29	Tool Box Transport Trolley	97	TX Bit Socket Set	217
Stack System Tool Kit	30-31	Tool Cabinet	80	TX Bit Socket Set	118, 214
Steel Rules	455	Tool Cabinet	81	TX Bit Socket Set	119, 214
Storage Tray	110	Tool Cabinet	82	TX Bit Sockets	207
Storage Tray	111	Tool Cabinet	83	TX Bit Sockets	218
Storage Tray	112	Tool Cabinet	84	TX Bit Sockets	247
Storage Tray	155	Tool Cabinet Castor Wheels	97	TX Bit Sockets	254
Straight Air Impact Wrench	513	Tool Cabinet Top Tray	92	TX Bit Sockets	261
Straight Cut Tin Snips	438	Tool Kit And Work Station	56-57	TX Bits	355
Straight/Left Cut Tin Snips	438	Tool Panel Set For Tcw207N	104	TX Bits	356
Straight/Right Cut Tin Snips	438	Top Box	75	TX Bits	357
Stubby 6 Point Impact Socket	271	Top Box Cover	91	TX Impact Bit Socket Set	123, 228
Stubby Combination Spanners	308	Torch	493	TX Impact Screwdriver Bit	356
Stubby Impact Socket Set	231	Torch	494	TX Key Set	393
Stud Extractor	479	Torque Multiplier Service Kits	293	TX Key Set	394
Stud Extractor Set	150, 480	Torque Multiplier Set	125, 293	TX Keys	391
Stud Extractors	479	Torque Multiplier Set	168, 293	TX Screwdriver	338
Suction Lifter	472	Torque Multiplier Support Legs	292	TX Screwdriver	338
Sv - Middle Box	79	Torque Multipliers	292	TX-E Bit Socket Set	207
Sv - Top Box	76	Torque Multipliers	293	TX-E Bit Socket Set	217
T Handle Bits Driver	369	Torque Screwdriver	282	TX-E Bit Sockets	246
T Handle Hex Key Set	138, 388	Torque Screwdriver Set	124, 282	TX-E Bit Sockets	255
T Handle Hex Key Set	138, 389	Torque Screwdriver Set	167, 282	TX-E Bit Sockets	259
T Handle Hex Key Set	139, 389	Torque Screwdriver Set	167, 283, 377	Tyre Levers	469
T Handle Hex Key Set	176, 389	Torque Spanner Set	294	Universal Joints	240
T Handle Hex Keys	383	Torque Spanners	293	Universal Puller Set	149, 477
T Handle Hex Keys	384	Torque Stick & Wheel Nut Socket Set	123, 228	Utility And Craft Knife Set	145, 445
T Handle Nut Drivers	342	Torque Sticks	275	Vernier Caliper	454
T Handle Tx & Tpx Keys	392	Torque Test Printer	295	Voltage Tester	484
T Handle Tx And Tpx Key Set	139, 394	Torque Tester Stand	295	Wall Hanging Tool Cabinet	101
T Handle Tx Key Set	177, 395	Torque Tester With Stand & Printer	295	Wall Hanging Tool Cabinet	102
T Handle Tx/Tpx Key Set	185, 395	Torque Wrench Service Kits	289	Water Pump Pliers	406
Tap And Die Set	145, 448	Torque Wrench Set	125, 285	Welding Plier Set	143
Tap And Die Set	146, 448	Torque Wrench Set	125, 288	Welding Power Grip Pliers	420
Tap Chuck Service Kits	447	Torque Wrench Set	168, 285	Welding Power Grip Pliers	421
Tap Handle	447	Torque Wrenches	283	Wheel Nut Socket Set	470
T-Bar Handle	241	Torque Wrenches	286	Wheel Nut Socket Set	471
T-Bar Socket Set	252	Torque Wrenches	288	Wheel Nut Sockets	470
T-Bar Sockets	251	Tote Tray	92	Wheel Tool Set	182, 471
T-Bar Spark Plug Sockets	465	Tower Pincer Pliers	403	Wide Jaw Adjustable Wrenches	329
T-Bar Spark Plug Sockets	251, 465			Wide Tool Cabinet	85

Wire Cutters	403
Wire Stripping Plier	409
Wire Stripping Tool	482
Wire Stripping Tool	483
Wire Twisting Plier	483
Wobble Extension Bars	238
Wooktops For Tool Cabinets	96
Work Bench Work Top	99
Work Station Add-On Panel Set	100
Work Station Left/Right Add-On Panel Set	101
Work Station Panel Set	100
Workbench Panel Kit	99
Workbench Vice	95
Workstation Tool Kit	55
Wrecking Bars	480
XZN Bit Impact Sockets	275
XZN Bit Sockets	263
XZN Impact Bit Socket Set	224

1200-72N	234	1471AFA	388	220730	357	3105025	380
1200-72NRK	236	1471MM	387	220740	357	3105025BL-C	381
1200-72SN	235	1471MMA	387	220745	357	310502BL-C	381
1200F	235	1473	396, 471	220750	357	310503	380
1200FRK	236	1474	385	220755	357	310503BL-C	381
1200FRP	235	1475	384	220760	357	310504	380
1200FRPRK	236	1476NAF	387	220770	357	3105045	380
1200L	235	1476NMM	386	220820	357	310504BL-C	381
1201	238	1476NMM1	386	220825	357	310505	380
1201A	238	1476NTX	393	220827	357	3105055	380
1201ARK	236, 238	1476NTX1	394	220830	357	310505BL-C	381
1201RK	236, 238	1476NTX2	394	220840	357	310506	380
1202	470	1477NX	396	220845	357	310506BL-C	381
1202A	470	1479AF	386	220850	357	310507	380
120955-C	469	1479MM	385	220855	357	310507BL-C	381
1292AG-090	287	1479MMA	385	220860	357	310508	380
1292AG-110	287	1479MMR	384	220870	357	310508BL-C	381
1292AG-120	287	1479MMRL	384	2300	479	310509	380
1292AG-140	287	1479TX	393	2912512	333	310510	380
1292AG4-CT	286	1479TX1	393	2912513	333	310510BL-C	381
1292AG4R-CT	286	1486	362	2912514	333	310511	380
1292AG4RK	289	1487	394	2912520	333	310512	380
1292AG4RRK	289	1488	362	2912535	333	310514	380
1292AG-E4	286	1492AG-CT	283	2912537	333	310516	380
1292AG-E4R	286	1492AG-E	283	2912539	333	310517	380
1292AG-EP	286	1492AGERK	289	310102	380	310518	380
1292AG-ER	286	1492TSD	282	3101025	380	310519	380
1292AGERK	289	1492TVSD	430	3101025BL	382	310522	380
1292AGERRK	289	1498TPX	395	310103	380	310527	380
1292AGP-CT	286	1499AF	386	3101035	380	310532	380
1292AGR-CT	286	1499MM	385	310103BL	382	310536	380
1292CQ200R	290	1499TX	393	310104	380	320008	391
1292D200	287	210705	358	3101045	380	320008BL	391
1292D200-CT	287	210706	358	310104BL	382	320009	391
1292P100	287	210707	358	310105	380	320009BL	391
1292P100-CT	287	210708	358	310105BL	382	320010	391
1292P100RK-1	289	210709	358	310106	380	320010BL	391
1292P200	287	210710	358	310106BL	382	320015	391
1292P200-CT	287	210712	358	310107	380	320015BL	391
1292P200RK-1	289	210714	358	310107BL	382	320020	391
1292P320	287	210717	358	310108	380	320020BL	391
1292P320-CT	287	210719	358	310108BL	382	320025	391
1292P418	290	210805	359	310110	380	320025BL	391
1292P912	290	210806	359	310110BL	382	320027	391
1400-72MN	234	210807	359	310112	380	320027BL	391
1400-72N	234	210808	359	310112BL	382	320030	391
1400-72NRK	236	210809	359	310114	380	320030BL	391
1400-72SN	235	210810	359	310116	380	320040	391
1400B	234, 362	210812	359	310120	380	320040BL	391
1400FRP	235	210814	359	3105007	380	320045	391
1400FRPRK	236	210817	359	3105009	380	320045BL	391
1400M	234	210819	359	3105013	380	320050	391
1424	388	220720	357	3105015	380	320050BL	391
1425	388	220725	357	3105015BL-C	381	3205015	381
1471AF	387	220727	357	310502	380	320502	381

3205025	381	390506BL	381	4008	328	510503	383
320503	381	390508BL	381	4008RK	328	510504	383
320504	381	390510BL	381	401-10	417	510505	383
320505	381	390808TPX	395	401-10F	417	510506	383
320506	381	390809TPX	395	401-12	417	510507	383
320508	381	390810TPX	395	401-12F	417	510508	383
320510	381	390815TPX	395	401-4	417	510510	383
3492AG1-CT	288	390820TPX	395	401-5	417	510512	383
3492AG2-CT	288	390825TPX	395	401-7	417	5106025	383
3492AG-CT	288	390827TPX	395	402	419	510603	383
3492AG-E	288	390830TPX	395	404-4	418	510604	383
3492AG-E1	288	390840TPX	395	404-6	418	510605	383
3492AG-E2	288	390908BL	392	404-6S	418	510606	383
3492AG-ER	289	390909BL	392	404-9	418	510607	383
3492AGERK	289	390910BL	392	406	419	510608	383
3492AGERRK	289	390915BL	392	406-6	419	520009	392
3492AGR-CT	289	390920BL	392	406-6P	420	520010	392
3492CQ500R	290	390925BL	392	406-6S	419	520015	392
3492P500	289	390927BL	392	406-6SP	420	520020	392
3492P500-CT	289	390930BL	392	406P	420	520025	392
3492P500RK-1	289	390940BL	392	406S	419	520027	392
3800-72N	234	4001	328	406SP	420	520030	392
3800-72NRK	236	4001RK	328	407	420	520040	392
3800-72SN	235	4002	328	407AS	421	520045	392
3800FRP	235	4002IQ	328	408	421	520050	392
3800FRPRK	236	4002IQRK	328	409	418, 465	520055	392
3892AG1-CT	283	4002RK	328	409P	421	580	496
3892AGIRK	289	4002WT	329	409SP	421	580A	497
3892AG3-CT	283	4002WTRK	329	410P	421	580C	94
3892AG3RK	289	4003	328	410SP	421	580CK	94
3892AG-E1	283	4003IQ	328	418S	420	580CM	94
3892AG-E3	283	4003IQRK	328	418SP	420	580CN	94
3892CQ100R	290	4003J	326	445W	409	580D	94
3892DI00	284	4003JRK	326	480	413	580J	94
3892DI00-CT	284	4003RK	328	490	438	580K	93
3892P060	284	4003WT	329	490W	439	580M	93
3892P060-CT	284	4003WTRK	329	491	438	580N	93
3892P060RK-1	289	4004	328	491W	439	580Q	497
3892PI00	284	4004IQ	328	492	438	580R	497
3892PI00-CT	284	4004IQRK	328	492W	439	580S	496
3901025BL	382	4004RK	328	493	438	581N1	493
390103BL	382	4004WT	329	494	439	581TMG	492
390104BL	382	4004WTRK	329	495	439	581TMI	492
390105BL	382	4005	328	496	401	581TMP	492
390106BL	382	4005IQ	328	497	440	582MI	492
390107BL	382	4005IQRK	328	498-7N	403	582NI	493
390108BL	382	4005RK	328	510103	384	583M	496
390110BL	382	4005WT	329	510104	384	583N1	494
390112BL	382	4005WTRK	329	510105	384	585	493
3905015BL	381	4006	328	510106	384	585MP	492
3905025BL	381	4006IQ	328	510107	384	586	495
390502BL	381	4006IQRK	328	510108	384	586A	494
390503BL	381	4006RK	328	510110	384	586C	494
390504BL	381	4007	328	510502	383	587AA	495
390505BL	381	4007RK	328	5105025	383	587AE	495

587AU	495	600510	298	600524	298	601013	316
587H	495	60051011RXRK	324	600524R	310	605908	308
587J	103	600510R	310	600524RS	312	605909	308
587M	494	600510RF	315	600525	298	605910	308
589MA	103	600510RS	312	600526	298	605911	308
589ME	103	600511	298	600527	298	605912	308
589MU	103	600511R	310	600527R	310	605913	308
600	315	600511RF	315	600528	298	605914	308
600108	299	600511RS	312	600529	298	605915	308
600110	299	600512	298	600530	298	605916	308
600110R	310	60051213RXRK	324	600530R	310	605917	308
600112	299	60051215RX	323	600532	298	605918	308
600112R	310	600512R	310	600532R	310	605919	308
600114	299	600512RF	315	600533	298	6059LMP	309
600114R	310	600512RS	312	600534	298	611214	322
600116	299	600513	298	600536	298	611618	322
600116R	310	600513R	310	600538	298	612022	322
600118	299	600513RF	315	600541	298	620607	320
600118R	310	600513RS	312	600546	298	6208	321
600120	299	600514	298	600550	298	620809	320
600120R	310	60051415RXRK	324	600555	298	621011	320
600122	299	600514R	310	600558	298	6211	321
600122R	310	600514RF	315	600560	298	6211MM	321
600124	299	600514RS	312	600565	298	621213	320
600124R	310	600515	298	600570	298	621415	320
600126	299	600515R	310	6005M10	308	621617	320
600126R	310	600515RF	315	6005M10RS	314	621819	320
600128	299	600515RS	312	6005M11	308	622022	320
600128R	310	600516	298	6005M11RS	314	622123	320
600130	299	60051617RXRK	324	6005M12	308	622427	320
600132	299	60051619RX	323	6005M12RS	314	623032	320
600134	299	600516R	310	6005M13	308	630607	316
600136	299	600516RF	315	6005M13RS	314	6308	318
600140	299	600516RS	312	6005M14	308	630809	316
600142	299	600517	298	6005M14RS	314	630810FL	317
600144	299	600517R	310	6005M15	308	6308MM	319
600146	299	600517RF	315	6005M15RS	314	631011	316
600148	299	600517RS	312	6005M16	308	6311	319
600152	299	600518	298	6005M16RS	314	631113FL	317
600156	299	60051819RXRK	324	6005M17	308	631213	316
600160	299	600518R	310	6005M17RS	314	631214FL	317
6005055	298	600518RF	315	6005M18	308	631415	316
600506	298	600518RS	312	6005M18RS	314	631617	316
600507	298	600519	298	6005M19	308	631618FL	317
600507RF	315	600519R	310	6005M19RS	314	631719FL	317
600508	298	600519RF	315	600813	325	631819	316
60050809RXRK	324	600519RS	312	600814	325	632022	316
60050811RX	323	600520	298	600816	325	632123	316
600508R	310	600520RS	312	600817	325	632224FL	317
600508RF	315	600521	298	600819	325	632427	316
600508RS	312	600521RS	312	600822	325	633032	316
600509	298	600522	298	600824	325	641011	323
600509R	310	600522R	310	600827	325	641213	323
600509RF	315	600522RS	312	600830	325	641314	323
600509RS	312	600523	298	600832	325	641617	323

641922	323	681719	324	690822	291	800615	306
6503RX	324	681820E	325	690824	291	800616	306
6507AF	304	682122	324	690826	291	800617	306
6507JAF	304	682224E	325	690827	291	800618	306
6507JMM	304	690510	291	690829	291	800619	306
6507JMMA	305	690511	291	690830	291	8512A	307
650809	322	690512	291	690832	291	8512MM	307
6508RMM	312	690513	291	690834	291	902024	327
6508RSMM	314	690514	291	690836	291	902027	327
6509AF	304	690515	291	690838	291	902030	327
651011	322	690516	291	690840	291	902032	327
651013	322	690517	291	690841	291	902036	327
6510A	305	690518	291	690842	291	902038	327
6510MM	302	690519	291	690844	291	902041	327
6510RMM	312	690613	292	690846	291	902046	327
6512	301	690614	292	691406	323	902050	327
651213	322	690615	292	700-PRO5	442	902055	327
6512MM	303	690616	292	701	441	902060	327
6512MM1	302	690617	292	701N	441	902065	327
6512MMA	305	690618	292	701NI	440	902070	327
6512N	301	690619	292	702	440, 441	902075	327
6512RSMM	314	690621	292	703	442	902080	327
651415	322	690622	292	703-10	442	902085	327
6515MM	302	690624	292	703-24	442	902090	327
6515MMA	305	690626	292	704	441	902095	327
651617	322	690627	292	705	441	902100	327
6517	301	690629	292	705-5	441	903024	327
6517MM	303	690630	292	705A	441	903027	327
651819	322	690632	292	705A-5	441	903030	327
6521	302	690634	292	710	444	903032	327
6526MM	303	690636	292	710-10	444	903036	327
6607AF	321	690638	292	710-100	444	903038	327
661416	323	690640	292	710-100H	445	903041	327
663032	320	690641	292	710-10H	445	903046	327
663436	320	690642	292	710A	442	903050	327
663840	320	690644	292	710A-10	442	903055	327
664244	320	690646	292	710A-100	443	903060	327
664648	320	690710	290	710C	443	903065	327
665052	320	690711	290	710F	442	903070	327
665456	320	690712	290	710F-10	443	903075	327
6707AF	319	690713	290	710F-100	443	903080	327
673032	316	690714	290	710G	443	903085	327
673436	316	690715	290	710H	442	903090	327
673840	316	690716	290	710N	444	903095	327
674244	316	690717	290	710S	443	903100	327
674648	316	690718	290	710U-10	444	910086	267
675052	316	690719	290	711	444	910504	376
675456	316	690813	291	712	444	910505	376
680608	324	690814	291	800608	306	910506	376
680709	324	690815	291	800609	306	910508	376
680810E	325	690816	291	800610	306	910510	376
681013	324	690817	291	800611	306	910524	278
68112E	325	690818	291	800612	306	910527	278
681214	324	690819	291	800613	306	910530	278
681416E	325	690821	291	800614	306	910532	278

910533	278	9124	487	920512AN	270	920621AN	272
910534	278	9126	231	920512N	270	920621N	272
910536	278	920001	376	920513AN	270	920622AN	272
910538	278	920002	376	920513N	270	920622N	272
910541	278	920003	376	920514AN	270	920623N	272
910546	278	920020AN	267	920514N	270	920624AN	272
910550	278	920020N	267	920515AN	270	920624N	272, 469
910555	278	920021AN	267	920515N	270	920627N	272, 469
910560	278	920021N	267	920516AN	270	920628N	272, 469
910565	278	920023AN	267	920516N	270	920629N	272, 469
910570	278	920023N	267	920517AN	270	920630N	272, 469
910575	278	920030AN	267	920517N	470	920632N	272, 469
910580	278	920030N	267	920517NI	270	920635N	272, 469
910585	278	920036AN	267	920518AN	270	920636N	272, 469
910590	278	920036N	267	920518N	270	920710-C	271
910595	278	920037AN	267	920519AN	270	920712-C	271
910624	279	920037N	267	920519N	470	920713-C	271
910627	279	920060-C	267	920519NI	270	920714-C	271
910627R	278	920112	271	920520N	270	920715-C	271
910628	279	920114	271	920521AN	270	920716-C	271
910630	279	920116	271	920521N	470	920717-C	271
910630R	278	920118	271	920521NI	270	920718-C	271
910632	279	920120	271	920522AN	270	920719-C	271
910632R	278	920122	271	920522N	270	920721-C	271
910633	279	920124	271	920523N	270	920722-C	271
910633R	278	920126	271	920524AN	270	920724-C	271
910636	279	920128	271	920524N	270	9207512	231
910732	279	920130	271	920525N	270	921210TX-C	274
9110	466	920132	271	920526N	270	921215TX-C	274
9110RK-1	466	920134	271	920527N	270	921220TX-C	274
9120	466	920136	271	920528N	270	921225TX-C	274
912041	279	920140	271	920529N	270	921227TX-C	274
912046	279	920212	273	920530N	270	921230TX-C	274
912050	279	920214	273	920532N	270	921240TX-C	274
912055	279	920216	273	920610AN	272	921245TX-C	274
912060	279	920218	273	920610N	272	921250TX-C	274
912065	279	920220	273	920611AN	272	921255TX-C	274
912070	279	920222	273	920611N	272	921260TX-C	274
912075	279	920224	273	920612AN	272	921270TX-C	274
912080	279	920226	273	920612N	272	921505-C	273
912085	279	920228	273	920613AN	272	921506-C	273
912090	279	920230	273	920613N	272	921508-C	273
912095	279	920232	273	920614AN	272	921510-C	273
9120HD	466	920234	273	920614N	272	921512-C	273
9120RK-1	466	920236	273	920615AN	272	921514-C	273
9121	231	920240	273	920615N	272	921517-C	273
912100	279	920242	273, 469	920616AN	272	921519-C	273
912105	279	920248	273, 469	920616N	272	921606	274
912110	279	9203N	471	920617AN	272	921608	274
912115	279	9203NI	470	920617N	272	921610	274
912120	279	920508N	270	920618AN	272	921612	274
912125	279	920510AN	270	920618N	272	921614	274
912130	279	920510N	270	920619AN	272	921616	274
9123	465	920511AN	270	920619N	272	921618	274
9123RK	465	920511N	270	920620N	272	921620	274

921622	274	940174	276	941522-C	277	ACD01	294
921624	274	940176	276	941524-C	277	ALU1000-1	96
921814	275	940224	277	960506-C	268	ALU1000-4	96
921816	275	940226	277	960507-C	268	ALU12	96
921817	275	940228	277	960508-C	268	ALU14	96
921818	275	940230	277	960510-C	268	ALU34	96
923090	275	940232	277	960513-C	268	ALU38	96
923110	275	940234	277	970030	376	ALU430	96
923120	275	940236	277	970040	376	ALU450	96
923140	275	940238	277	970045	376	ARAG125	517
923814	275	940240	277	970050	376	ARB01	519
923816	275	940242	277	970055	376	ARB02	519
923817	275	940244	277	980020-C	267	ARB03	519
923818	275	940246	277	980035-C	267	ARBS10	517
9291719	470	940248	277	980036A-C	267	ARC80	515
9292122	470	940250	277	980036-C	267	ARD10	513
930001	376	940252	277	980060-C	267	ARD13	514
930002	376	940254	277	980086	267	AREP25	519
930003	376	940256	277	980508-C	268	ARG01	516
930004	376	940258	277, 469	980510-C	268	ARG02	516
9381	230	940260	277	980511-C	268	ARN12	518
9386	230	940519-C	275	980512-C	268	ARR12	508
940006	376	940521-C	275	980513-C	268	ARRG80	518
940008	376	940522-C	275	980514-C	268	ARRG80-IRK	518
940010	376	940523-C	275	980515-C	268	ARRG80-3RK	518
940012	376	940524-C	275	980516-C	268	ARRM38	508
940022-C	267	940527-C	275	980517-C	268	ARS01	514
940030-C	267	940528-C	275	980519-C	268	ARS02	515
940037-C	267	940530-C	275	980608-C	269	ARWC12	512
940085-C	267	940532-C	275	980610-C	269	ARWC34	512
940122	276	940533-C	275	980611-C	269	ARWC38	511
940124	276	940534-C	275	980612-C	269	ARWM11S	513
940126	276	940536-C	275	980613-C	269	ARWM12	510
940128	276	940538-C	275	980614-C	269	ARWM12M	509
940130	276	940540-C	275	980616-C	269	ARWM34	511
940132	276	940541-C	275	980617-C	269	ARWM38	510
940134	276	940546-C	275	980619-C	269	AT020	467
940136	276	940550-C	275	981504-C	269	AT040	467
940138	276	940619-C	276	981505-C	269	AT040-SM	467
940140	276	940621-C	276	981506-C	269	AT080	463
940142	276	940622-C	276	981507-C	269	AT085	463
940144	276	940623-C	276	981508-C	269	AT090	463
940146	276	940624-C	276	981510-C	269	AT096	406
940148	276	940627-C	276	981512-C	269	AT097	406
940150	276	940630-C	276	9850	483	ATI35	491
940152	276	940632-C	276	AB200	457	ATI35M	491
940154	276	940633-C	276	ABS-TOP	92	ATI60	467
940156	276	940634-C	276	ACC300CBH01	361	AT170	467
940160	276	940636-C	276	ACC35CBH01	360	AT180	467
940162	276	940638-C	276	ACC50CBH01	360	AT180-S	467
940164	276	940641-C	276, 469	ACC50MBH01	360	AT191	468
940166	276	940646-C	276	ACC70MBH01	360	AT192	468
940168	276	940650-C	276	ACCSDA1412	361	AT194	468
940170	276	940732-C	277	ACCSDA1414	361	AT195	468
940172	276	941519-C	277	ACCSDA1438	361	AT20512	469

AT20516	469	CMFQ25	499	DBX125	445	GRP5000201	354
AT20520	469	CMFQ30	499	DBX130	445	HBH0303	340
AT20524	469	CMFQ40	499	DET01	486	HBH0404	340
AT330	468	CMQ150	498	DET01RK	486	HBH0505	340
AT350	469	CMQ300	498	DET02	487	HBH0606	340
AT355	469	CMQ450	498	DGMM	455	HEX2500203	357
AT360	469	CMQ600	498	DHW1300	499	HEX2500303	357
AT365	469	CMQL150	498	DHW1417	499	HEX2500403	357
AT370	469	CMQL300	498	DHW1922	499	HEX2500503	357
AT375	469	CMQL450	498	DIE-HNDL	447	HEX2500603	357
AT380	469	CP04	501	DIS-SP05	477	HEX2500803	357
AT415	472	CP04RK1	481	DIS-SP05Q	477	HEX5000403	358
AT420	472	CP04RK2	481	DM550	484	HEX5000503	358
AT500	475	CP04RK3	481	DP0810	466	HEX5000603	358
AT605	483	CP05	501	DP0812	466	HEX5000803	358
BC408	402	CP08	501	DP1012	466	HEX8900401	358
BC408T	402	CP50	481	DP1112	466	HEXP3000301	358
BC414	402	CP51	482	DP1314	466	HEXP3000305	358
BC414J	402	CP52	481	DP1716	466	HEXP3000401	358
BC418	402	CP53	482	DTQ100RK	289	HEXP3000405	358
BC418J	402	CP55	483	DTQ200RK	289	HEXP3000501	358
BC424	402	CP58	481	FC01	471	HEXP3000505	358
BC424J	402	CP60	482	FG13100	454	HEXP3000601	358
BC430	402	CTG01	483	FG20100	454	HEXP3000605	358
BC430J	402	DB028	446	FG20200	454	HEXP5000301	358
BC436	402	DB034	446	FL2506A03	352	HEXP5000401	358
BC436J	402	DBT35	486	FL2506B03	352	HEXP5000501	358
BWT406	487	DBT41	486	FL2508A03	352	HEXP5000601	358
CALD150	454	DBT54	486	FL2508B03	352	HMBH01	473
CALV150	454	DBX010	445	FL2510A03	352	HMBH02	473
CC150F	502	DBX015	445	FL2512A03	352	HMBH03	473
CC200F	502	DBX020	445	FL2516A03	352	HMBH16	501
CC240F	502	DBX025	445	FL5006A03	352	HMBP12	499
CC250F	502	DBX030	445	FL5008A03	352	HMBP16	499
CMD12	498	DBX033	445	FL5008B03	352	HMBP24	499
CMD16	498	DBX035	445	FL5010A03	352	HMBP32	499
CMD20	498	DBX040	445	FL5012A03	352	HMCH08A	500
CMD25	498	DBX042	445	FL7006A02	352	HMCH13A	500
CMD30	498	DBX045	445	FL7008A02	352	HMCH16A	500
CMD30A	498	DBX050	445	FL7008B02	352	HMCH16M	501
CMD40	498	DBX055	445	FL7010A02	352	HMCH20A	500
CMD40A	498	DBX060	445	FL8905A01	352	HMCHC16	501
CMD50	498	DBX065	445	FL8908A01	352	HMCHM16	500
CMD80	498	DBX068	445	FLFT10	450	HMDH35	473
CMF16	499	DBX070	445	FLHF10	450	HMDH45	473
CMF16T	498	DBX075	445	FLHR10	450	HMDH55	473
CMF20	499	DBX080	445	FLRD10	450	HMDH65	473
CMF20T	498	DBX085	445	FLSQ10	450	HMEG300	499
CMF25	499	DBX090	445	FLTR10	450	HMEG500	499
CMF25T	498	DBX095	445	FTF32406005	352	HMEG800	499
CMF30	499	DBX100	445	FTF4055	340	HMSI250	500
CMF30T	498	DBX105	445	GR25002010	353	HMSF	500
CMF35	499	DBX110	445	GR25002100	353	HMSFRK	500
CMF35T	498	DBX115	445	GRP3000201	354	HN02	489
CMFQ20	499	DBX120	445	GRP3000205	354	HN02RK	489

HP101	326	M110555	265	M120511-C	257	M1206176-C	258
HP102	326	M110558	265	M1205126-C	256	M120617-C	258
HP103	326	M110560	265	M120512-C	257	M1206186-C	258
HP2014	326	M110565	265	M1205136-C	256	M120618-C	258
HP2014-P	326	M110570	265	M120513-C	257	M1206196-C	258
HP2015	326	M110575	265	M1205146-C	256	M120619-C	258
HP2015-P	326	M110580	265	M120514-C	257	M120620-C	258
HP2025	326	M1115MM	221	M1205156-C	256	M120621-C	258
HP2026	326	M120010-C	238	M120515-C	257	M120622-C	258
HP2026-P	326	M120010RK	238	M1205166-C	256	M1206246-C	258
HP2036	326	M120011-C	238	M120516-C	257	M120624-C	258
HP2036-P	326	M120020-C	239	M1205176-C	256	M120627-C	258
HP2038	326	M120020W-C	238	M120517-C	257	M120630-C	258
HP2038-P	326	M120021-C	239	M1205186-C	256	M120632-C	258
HR01	488	M120021W-C	238	M120518-C	257	M120636-C	258
HR01RK	488	M120022-C	239	M1205196-C	256	M1207	215
HR12	488	M120022W-C	238	M120519-C	257	M120710-C	259
HR12RK	488, 489	M120023-C	239	M1205206-C	256	M120711-C	259
HR14	488	M120024-C	239	M120520-C	257	M120712-C	259
HR14RK	488	M120030-C	240	M1205216-C	256	M120714-C	259
HR30R	488	M120036-C	240	M120521-C	257	M120716-C	259
HR30RRK-1	488	M120037-C	240	M1205226-C	256	M120718-C	259
HR30RRK-2	488	M120037M	241	M120522-C	257	M120720-C	259
HR360R	489	M120040-C	464	M1205236-C	256	M120722-C	259
HRLN65N	490	M120042-C	464	M120523-C	257	M120724-C	259
HRLN65NRK-1	490	M120046-C	464	M1205246-C	256	M1208-6	216
HRLR01	489	M120050-C	241	M120524-C	257	M1209	218
HRLR01RK-2	489	M120060-C	240, 361	M1205256-C	256	M1209AF	216
HRLR01RK-3	489	M120061-C	240, 361	M120525-C	257	M1209TX	218
HRLT01	489	M120062-C	240, 361	M1205266-C	256	M1210	217
HRLT01RK	489	M120063-C	240, 361	M120526-C	257	M1211	217
IBA14	360	M120080-C	240	M1205276-C	256	M121106-C	260
ID506	375	M120112-C	257	M120527-C	257	M121107-C	260
ID506BIT	375	M120114-C	257	M1205286-C	256	M121108-C	260
ID515	375	M120116-C	257	M120528-C	257	M121109-C	260
ID515BIT	375	M120118-C	257	M1205296-C	256	M121110-C	260
IDSE7	376	M120119-C	257	M120529-C	257	M121112-C	260
KP01	495	M120120-C	257	M1205306-C	256	M121116-C	260
KP02	495	M120122-C	257	M120530-C	257	M121118-C	260
KP03	495	M120124-C	257	M1205326-C	256	M121120-C	260
M1100	236	M120125-C	257	M120532-C	257	M1212	216
M110010	236	M120126-C	257	M1205336-C	256	M121220-C	262
M110020	236	M120128-C	257	M1205346-C	256	M121220T-C	261
M110030	240	M120130-C	257	M120534-C	257	M121225-C	262
M110040	239	M120132-C	257	M120610-C	258	M121225T-C	261
M110050	239	M120134-C	257	M120611-C	258	M121227-C	262
M110070	238	M120136-C	257	M120612-C	258	M121227T-C	261
M110070RK	238	M120138-C	257	M1206136-C	258	M121230-C	262
M1100-72	235	M120140-C	257	M120613-C	258	M121230T-C	261
M1100-72RK	236	M1205086-C	256	M1206146-C	258	M121240-C	262
M1100RK	236	M120508-C	257	M120614-C	258	M121240T-C	261
M110536	265	M120509-C	257	M1206156-C	258	M121245-C	262
M110541	265	M1205106-C	256	M120615-C	258	M121245T-C	261
M110546	265	M120510-C	257	M1206166-C	258	M121250-C	262
M110550	265	M1205116-C	256	M120616-C	258	M121250T-C	261

M121255-C	262	M122809-C	263	M140212-C	245	M1412	197
M121255T-C	261	M122810-C	263	M14021412-C	245	M141210T-C	247
M121260-C	262	M122812-C	263	M140214-C	245	M141215T-C	247
M121260T-C	261	M122814-C	263	M14021612-C	245	M141220T-C	247
M1212N1	208	M122816-C	263	M140216-C	245	M141225T-C	247
M1213TPX	217	M140015-C	237	M14050412-C	242	M141227T-C	247
M1213TX	217	M140020-C	239	M1405045-C	242	M141230T-C	247
M121505-C	259	M140021-C	239	M140504-C	242	M141240T-C	247
M121506-C	259	M140022-C	239	M14050512-C	242	M141300-C	246
M121507-C	259	M140023-C	239	M140505512-C	242	M141301-C	246
M121508-C	259	M140024-C	239	M1405055-C	242	M141302-C	246
M121509-C	259	M140030-C	240	M140505-C	242	M141303-C	246
M121510-C	259	M140036-C	240	M14050612-C	242	M1413N1	190
M121512-C	259	M140036M	241	M140506-C	242	M141404-C	246
M121514-C	259	M140037	240	M14050712-C	242	M1414055-C	246
M121515-C	259	M140038-C	239	M140507-C	242	M141407-C	246
M121516-C	259	M140039	240	M14050812-C	242	M141601-C	246
M121517-C	259	M140050-C	241	M140508-C	242	M141602-C	246
M121518-C	259	M140060-C	240, 361	M14050912-C	242	M141603-C	246
M121519-C	259	M140070	447	M140509-C	242	M340020-C	239
M1215AF	216	M140071	447	M14051012-C	242	M340020S-C	239
M1215MM	215	M140071RK	447	M140510-C	242	M340021-C	239
M122220T-C	261	M140072	447	M14051112-C	242	M340021S-C	239
M122225T-C	261	M140072RK	447	M140511-C	242	M340022-C	239
M122227T-C	261	M14010612-C	243	M14051212-C	242	M340022S-C	239
M122230T-C	261	M140106-C	243	M140512-C	242	M340030-C	240
M122240T-C	261	M14010712-C	243	M14051312-C	242	M340050-C	241
M122245T-C	261	M140107-C	243	M140513-C	242	M340050S-C	241
M122250T-C	261	M14010812-C	243	M140513-C	242	M340050S-C	241
M122255T-C	261	M140108-C	243	M140604-C	244	M340070-C	238
M122260T-C	261	M14010912-C	243	M1406055-C	244	M340070RK	238
M122270T-C	261	M140109-C	243	M140605-C	244	M340070S-C	238
M122505-C	260	M14011012-C	243	M14060612-C	244	M340070SRK	238
M122506A-C	260	M14011012-C	243	M140606-C	244	M3400-72	235
M122506-C	260	M140110-C	243	M14060712-C	244	M340072E	236
M122507-C	260	M14011112-C	243	M140607-C	244	M3400-72RK	236
M122508A-C	260	M140111-C	243	M14060812-C	244	M340085-C	240
M122508-C	260	M14011212-C	243	M140608-C	244	M340085M	241
M122510-C	260	M140112-C	243	M14060912-C	244	M340086-C	240
M122510L-C	260	M14011412-C	243	M140609-C	244	M340124-C	264
M122512-C	260	M140114-C	243	M14061012-C	244	M340128-C	264
M122514-C	260	M14011612-C	243	M140610-C	244	M340130-C	264
M122517-C	260	M140116-C	243	M14061112-C	244	M340132-C	264
M122704-C	262	M14020612-C	245	M140611-C	244	M340134-C	264
M122705-C	262	M140206-C	245	M14061212-C	244	M340136-C	264
M122706-C	262	M14020712-C	245	M140612-C	244	M340138-C	264
M122708-C	262	M140207-C	245	M14061312-C	244	M340140-C	264
M122709-C	262	M14020812-C	245	M140613-C	244	M340142-C	264
M122710-C	262	M140208-C	245	M1407	197	M340144-C	264
M122711-C	262	M14020912-C	245	M140704-C	246	M340146-C	264
M122712-C	262	M140209-C	245	M140705-C	246	M340148-C	264
M122713-C	262	M14021012-C	245	M140706-C	246	M340152-C	264
M122805-C	263	M140210-C	245	M140707-C	246	M340156-C	264
M122806-C	263	M14021112-C	245	M140708-C	246	M340158-C	264
M122808-C	263	M140211-C	245	M1408TX	197	M340160-C	264
		M14021212-C	245	M1410T5	362	M340164-C	264

M3405196-C	263	M38012212-C	249	M380608-C	249	M381225T-C	254
M3405216-C	263	M380122-C	248	M38060912-C	250	M381227-C	255
M3405226-C	263	M38012412-C	249	M380609-C	249	M381227T-C	254
M3405246-C	263	M380124-C	248	M38061012-C	250	M381230-C	255
M3405266-C	263	M380126-C	248	M380610-C	249	M381230T-C	254
M3405276-C	263	M380128-C	248	M3806112-C	250	M381240-C	255
M3405306-C	263	M38021212-C	251	M380611-C	249	M381240T-C	254
M3405326-C	263	M380212-C	250	M38061212-C	250	M381245-C	255
M3405336-C	263	M38021412-C	251	M380612-C	249	M381245T-C	254
M3405346-C	263	M380214-C	250	M38061312-C	250	M381250-C	255
M3405366-C	263	M38021612-C	251	M380613-C	249	M381250T-C	254
M3405386-C	263	M380216-C	250	M38061412-C	250	M3812N1	198
M3405416-C	263	M38021812-C	251	M380614-C	249	M3813TPX	206
M3405466-C	263	M380218-C	250	M38061512-C	250	M3813TX	206
M3405506-C	263	M38022012-C	251	M380615-C	249	M3814	207
M341514-C	264	M380220-C	250	M38061612-C	250	M381503-C	252
M341517-C	264	M38022212-C	251	M380616-C	249	M381504-C	252
M341519-C	264	M380222-C	250	M38061712-C	250	M3815055-C	252
M341522-C	264	M38022412-C	251	M380617-C	249	M381505-C	252
M380010A-C	238	M380224-C	250	M38061812-C	250	M381506-C	252
M380011-C	238	M380226-C	250	M380618-C	249	M381507-C	252
M380015-C	237	M380228-C	250	M38061912-C	250	M381508-C	252
M380020-C	239	M380507-C	247	M380619-C	249	M381510-C	252
M380020W-C	238	M38050812-C	248	M38062012-C	250	M381512-C	252
M380021-C	239	M380508-C	247	M380620-C	249	M3816	205
M380021W-C	238	M38050912-C	248	M38062112-C	250	M382210T-C	254
M380022-C	239	M380509-C	247	M380621-C	249	M382215T-C	254
M380022W-C	238	M38051012-C	248	M38062212-C	250	M382220T-C	254
M380023-C	239	M380510-C	247	M380622-C	249	M382225T-C	254
M380024-C	239	M38051112-C	248	M3807	205	M382227T-C	254
M380030-C	240	M380511-C	247	M380710-C	255	M382230T-C	254
M380035-C	240	M38051212-C	248	M380712-C	255	M382240T-C	254
M380036-C	240	M380512-C	247	M380714-C	255	M382245T-C	254
M380036M	241	M38051312-C	248	M380716-C	255	M382250T-C	254
M380037	240	M380513-C	247	M380718-C	255	M382503-C	253
M380039-C	464	M38051412-C	248	M3808MM	207, 256	M382504-C	253
M380040-C	464	M380514-C	247	M3809	206	M3825055-C	253
M380041-C	464	M38051512-C	248	M3809TX	207	M382505-C	253
M380042-C	464	M380515-C	247	M3811	206	M382506-C	253
M380046-C	464	M38051612-C	248	M381103-C	253	M382507-C	253
M380047-C	464	M380516-C	247	M381104-C	253	M382508-C	253
M380050-C	241	M38051712-C	248	M381105-C	253	M382510-C	253
M380060-C	240, 361	M380517-C	247	M381106-C	253	M382512-C	253
M380061-C	240, 361	M38051812-C	248	M381107-C	253	M382704-C	255
M380110-C	248	M380518-C	247	M381108-C	253	M382705-C	255
M38011212-C	249	M38051912-C	248	M381110-C	253	M382706-C	255
M380112-C	248	M380519-C	247	M381112-C	253	M382708-C	255
M38011412-C	249	M380520-C	247	M3812	205	M382709-C	255
M380114-C	248	M380521-C	247	M381210-C	255	M382710-C	255
M38011612-C	249	M38052212-C	248	M381210T-C	254	M386510-C	256
M380116-C	248	M380522-C	247	M381215-C	255	M386511-C	256
M38011812-C	249	M3806	207	M381215T-C	254	M386512-C	256
M380118-C	248	M38060712-C	250	M381220-C	255	M386513-C	256
M38012012-C	249	M380607-C	249	M381220T-C	254	M386514-C	256
M380120-C	248	M38060812-C	250	M381225-C	255	M386515-C	256

M386516-C	256	MB471-9	414	MD514N	237	MD923N1	336
M386517-C	256	MB472-5	415	MD610TPN	338	MD925TN	338
M386518-C	256	MB472-7	415	MD615TPN	338	MD927TN	338
M386519-C	256	MB472-9	415	MD620TPN	338	MD928N	336
MB410	406	MB473-5	415	MD625TPN	338	MD928N1	336
MB412	406	MB473-7	415	MD627TPN	338	MD928N2	336
MB416	406	MB473-9	415	MD630TPN	338	MD928N3	336
MB441-5	400	MB481-10	406	MD640TPN	338	MD928N4	336
MB441-5T	400	MB481-10Q	407	MD7020HBN	339	MD928N5	336
MB441-6	400	MB481-10T	406	MD7020HBN	339	MD928N6	336
MB441-6T	400	MB481-10TQ	407	MD7025HBN	339	MD928N7	336
MB442-5	400	MB481-7	406	MD7025HBN	339	MD930N	336
MB442-6	400	MB481-7T	406	MD7030HBN	339	MD930TN	338
MB442-6T	400	MB482-10Q	406	MD7030HBN	339	MD931N	336
MB442-7	400	MB482-10TQ	407	MD7040HBN	339	MD932N	336
MB442-7S	400	MB482-7Q	406	MD7050HBN	339	MD932N1	336
MB442-8	400	MB489-7	403	MD7060HBN	339	MD932N2	336
MB442-8T	400	MB489-8	403	MD7080HBN	339	MD934N	336
MB442B-8T	400	MB499-7T	409	MD801N	340	MD935N	336
MB444-10	401	MB541-5	403	MD802N	340	MD940N	337
MB444-6	401	MB541-6	403	MD803N	340	MD940N1	337
MB444-8	401	MB541-7	403	MD901	340	MD940TN	338
MB444-8T	401	MBE470-5	413	MD9053N	346	MD945TN	338
MB445-10	401	MBE470-7	413	MD906N	347	MD947N	337
MB448-6	403	MBE470-9	413	MD906N1	348	MD947N1	337
MB448-8	403	MBE471-5	413	MD906N2	348	MD947N2	337
MB449-10	403	MBE471-7	413	MD906N3	348	MD948N	337
MB449-11	403	MBE471-9	413	MD906N4	348	MD948N1	337
MB449-9	403	MBE472-5	414	MD906N5	347	MD948N2	337
MB451-7	404	MBE472-7	414	MD906TN	338	MD948N3	337
MB451-8	404	MBE472-9	414	MD907FL	369	MD948N4	337
MB452-6	404	MBE473-5	414	MD907TN	338	MD948N5	337
MB452-6T	404	MBE473-7	414	MD908N	370	MD948N6	337
MB452-7	404	MBE473-9	414	MD908TN	338	MD948N8	337
MB452-7T	404	MBH14	360	MD909TN	338	MD949N	337
MB452-8	404	MBM441	410	MD910N	346	MD950N	337
MB452-8T	404	MBM449	410	MD910TN	338	MD952N	337
MB452-9	404	MBM461	410	MD911N	347	MD952N1	337
MB461-5	404	MBM464	410	MD912N	349	MD953N	337
MB461-6	404	MBM467	411	MD912N1	349, 429	MD954N	337
MB461-6T	404	MBM468	411	MD914N	336	MD960N	337
MB461-8	404	MBM469	411	MD915N	336	MD961N	337
MB461-8T	404	MBV441-6	431	MD915N1	336	MD961N1	337
MB463-5	405	MBV442-8	431	MD915TN	338	MD961N2	337
MB463-6	405	MBV451-7	431	MD916N	336	MD962N	337
MB463-8	405	MBV451-8	431	MD916N1	336	MD962N1	337
MB463-8T	405	MBV461-8	431	MD916N2	336	MD962N2	337
MB464-6	405	MBV499-7	432	MD917N	336	MD962N3	337
MB464-6T	405	MD193	369	MD917N1	336	MD962N4	337
MB465-6	405	MD216	369	MD917N2	336	MD962N4A	337
MB470-5	414	MD503N	463	MD920N	336	MD962N4C	337
MB470-7	414	MD503NA	463	MD920N1	336	MD962N4D	337
MB470-9	414	MD503ND	463	MD920TN	338	MD962N5	337
MB471-5	414	MD503RK	463	MD922N	336	MD963N	337
MB471-7	414	MD514L	237	MD923N	336	MD964N	337

MDA180	461	MDP90	461	MP1400RK-1	293	O95034	267
MDA-R	461	MDQ147	370	MP2700	292	O95036	267
MDA-SQ	461	MDQ183	370	MP2700RK-1	293	O95046	267
MDBH	369	MDQ217	370	MP91500	293	O97043	267
MDH-L	461	MDR908	371	MP91500RK	293	O97045	267
MDH-S	461	MDR908S	370	MPSL01	292	O97051	267
MDM700	333	MDR915	371	MPSL02	292	P90433	267
MDM706	333	MDRQ908	371	MR500	343	P90435	267
MDM706TX	333	MDRT908	371	MT03	458	P90445	267
MDM706TXT	334	MD-SCR	461	MT03MM	458	P90543	267
MDM711	332	MDT932N	341	MT05	458	P90545	267
MDM712	332	MDT934N	341	MT05MM	458	P90551	267
MDM713	332	MDT935N	341	MT08	458	P906110	267
MDM714	332	MDT952N	341	MT08MM	458	P90675	267
MDM715	332	MDT953N	341	MT10	458	P92320	267
MDM716	332	MDTHQ	369	MT15	458	P92325	267
MDM717	332	MDV700	426	MT30	458	PB12	480
MDM718	332	MDV710	426	MTS30	458	PB12A	480
MDM806	332	MDV724N	424	MTS50	458	PB16	480
MDM806T	334	MDV726N	424	MV3800	434	PB18A	480
MDM807	332	MDV731	427	MV380020	434	PB20	480
MDM807T	334	MDV732	427	MV380021	434	PB22A	480
MDM808	332	MDV733	427	MV380506	434	PCCAP	502
MDM808T	334	MDV734	427	MV380507	434	PCX05	503
MDM809	332	MDV742N	425	MV380508	434	PF190	480
MDM809T	334	MDV744N	425	MV380509	434	PF380	480
MDM810	332	MDV751	427	MV380510	434	PGW1719	325
MDM810T	334	MDV752	427	MV380511	434	PGW1922	325
MDM815	332	MDV762N	425	MV380512	434	PGW1924	325
MDM815T	334	MDV764N	425	MV380513	434	PGW2124	325
MDMC702N	335	MDV771	427	MV380514	434	PGW2430	325
MDMC715N	335	MDV772	427	MV380515	434	PGW2730	325
MDMC718N	334	MDV802N	426	MV380516	434	PH2500103	353
MDN505	342	MDV820N	424	MV380517	434	PH2500110	353
MDN5055	342	MDV822N	424	MV380518	434	PH2500203	353
MDN506	342	MDV823N	424	MV380519	434	PH2500210	353
MDN507	342	MDV824N	424	MV380520	434	PH2500303	353
MDN508	342	MDV826N	424	MX04	241	PH2500310	353
MDN510	342	MDV828N	424	NS02	478	PH5000103	353
MDN511	342	MDV840N	425	NS02RKKL	478	PH5000203	353
MDN512	342	MDV842N	425	NS02RKS	478	PH5000303	353
MDN513	342	MDV844N	425	NS45108M	359	PH7000102	353
MDNT405	342	MDV844NF	426	NS45506M	359	PH7000202	353
MDNT4055	342	MDV846N	425	NS45507M	359	PH8900101	353
MDNT406	342	MDV860N	425	NS45508M	359	PH8900201	353
MDNT407	342	MDV862N	425	NS45508R	359	PHF0365	340
MDNT408	342	MDV864N	425	NSP65108	360	PHH0102	340
MDNT409	342	MDV864NF	426	NSP65507	360	PHH32000305	352
MDNT410	342	MDV866N	425	NSP65508	360	PHH32010205	352
MDNT411	342	MDV906N	429	NSP65510	360	PHP3000101	353
MDNT412	342	MDV9855	484	NSP65513	360	PHP3000105	353
MDNT413	342	MH75	497	O9100115	267	PHP3000201	353
MDNT414	342	MH90	497	O910075	267	PHP3000205	353
MDP125	462	MIR25	454	O92194	267	PHP3000301	353
MDP35	462	MP1400	292	O92244	267	PHP3000305	353

PHP5000101	353	ROBP3000201	359	SLP3180	412	ST12510-C	479
PHP5000201	353	ROBP3000205	359	SLT01	459	ST12510RK-1	479
PHP5000301	353	ROBP5000101	359	SLT02	459	ST12512-C	479
PHP8900201	353	ROBP5000201	359	SP11	475	ST12512RK-1	479
PM14	234	ROBP5000301	359	SP1410	476	ST200	455
PP03	501	ROBP8900101	359	SP1410Q	476	ST38112	479
PP04	501	ROBP8900201	359	SP1810	476	ST38116	479
PP05	501	ROBP8900301	359	SP1810Q	476	ST38122	479
PP06	501	SC01	62	SP22	475	ST38306	479
PP07	501	SC02	62	SP2215	476	ST38308	479
PP08	501	SC03	63	SP2215Q	476	ST38310	479
PPS06	503	SC04	63	SP2615	476	ST38311	479
P-SG01	506	SC04E	64	SP2615Q	476	ST38312	479
P-SG02	506	SCE1	64	SP31410	476	ST38313	479
P-SG03	506	SCE2	65	SP31410Q	476	ST38314	479
PT3810R	237	SCP01	502	SP31810	476	ST38316	479
P-UKF	444	SCPS01	113	SP31810Q	476	ST38317	479
PWC12	409	SCPS01E	113	SP32215	476	STMM1150	455
PWC14	409	SCR01	491	SP32215Q	476	T1220AF	208
PWC18	409	SCR02	491	SP32615	476	T1221	209
PWC24	409	SD501	492	SP32615Q	476	T1221-6	209
PWC36	409	SE05	478	SP3320	476	T1230	210
PZ2500103	354	SE141	477	SP3320Q	476	T1234	210
PZ2500110	354	SE142	477	SP33320	476	T1244	211
PZ2500203	354	SE143	477	SP33320Q	476	T1268	211
PZ2500210	354	SEL01S	478	SPA11	475	T1272	221
PZ2500303	354	SEL02S	478	SPA22	475	T1408	191
PZ2500310	354	SEL03S	478	SPBP20	464	T1419	191, 366
PZ5000103	354	SEL04S	478	SQAA200	457	T1420	192, 367
PZ5000203	354	SEL05S	478	SQAA250	457	T1422	192
PZ5000303	354	SG713	505	SQAA300	457	T1423	192
PZ7000102	354	SG713G	506	SQAB10070	456	T1424	192
PZ7000202	354	SG960	504	SQAB150100	456	T1424S	193
PZ8900101	354	SG960A	505	SQAB200130	456	T1435AF	193
PZ8900201	354	SG960G	505	SQAB300175	456	T1436	194
PZP3000101	355	SG960Y	505	SQAC300	457	T1460	194
PZP3000105	355	SL01	472	SQAP250	457	T3418-6	218
PZP3000201	355	SL02	472	SQAP300	457	T3422S	219
PZP3000205	355	SL03	472	SR1160	440	T3834	198
PZP3000301	355	SLA0300	459	SR1180	440	T3834S	199
PZP3000305	355	SLA040	459	SR2180	440	T3835AF	199
PZP5000101	355	SLA0400	459	SR3160	440	T3839	200
PZP5000201	355	SLA0600	459	SSH01	503	T3840	200
PZP5000301	355	SLA1000	459	SSH02	504	T3848	201
PZP8900201	355	SLA1200	459	SSH03	504	T3867	201
PZZ0102	340	SLA1500	459	SSH04	504	T9206	224
PZZ32000305	354	SLA1800	459	ST12319	479	T9218AF	225
PLM32010205	354	SLM0300	459	ST12321	479	T9218LAF	225
QC114	360	SLM0400	459	ST12322	479	T9222	224
RHA14	234, 362	SLM0600	459	ST12324	479	T9222L	224
ROB2500103	359	SLM1000	459	ST12325	479	T9240	225
ROB2500203	359	SLM1200	459	ST12506-C	479	T9417	225
ROB2500303	359	SLP1160	412	ST12506RK-1	479	T9417L	226
ROBP3000101	359	SLP2180	412	ST12508-C	479	T9421LAF	226
ROBP3000105	359	SLP3160	412	ST12508RK-1	479	T9423AF	226

TAP-HNDL	447	TCAV4	95	TCMME09C	51	TCW816LN-STACK	74
TBBSI27	368	TCB135	102	TCMME11A	50	TCW819STACK	74
TBNSI5	369	TCB180	102	TCMME174	53	TCW907X	84
TBSKT07	251	TCB80	101	TCMME179	52	TC-WC02	91
TBSKT08	251	TCB80A	101	TCMME846N	34-35	TCW-CAB	88
TBSKT10	251	TCB80C	101	TCMMIND08	42-43	TCW-CAB01	88
TBSKT12	251	TC-BKEY	98	TCMONSTER01	12-13	TCW-CAB02	88
TBSKT13	251	TCC01	103	TCMONSTER02	14-15	TCW-CAB03	88
TBSKT14	251	TCC02	103	TCNBC	97	TCW-HK02	96, 103
TBSKT17	251	TCC03	103	TCP445C	90	TCW-HK03	96, 103
TBSKT19	251	TC-COVER	91	TC-PA01	102	TCW-HK10	96, 103
TBUSP14	465	TC-COVER1	92	TC-PA02	102	TCW-HK45	96, 103
TBUSP16	465	TCDIVL	93	TC-PA03	102	TCW-HK90	96, 103
TBUSP21	465	TCDIVS	93	TCPRK	98	TCW-SP	95
TBW10	252	TCDRK	98	TCRFH	97	TCW-SP01	95
TC103NF	90	TCDSH	97	TC-S01	100	TDD03050	447
TC144D	68	TCEMM1117N	32-33	TC-S02	100	TDD04070	447
TC144E	69	TCEMM249N	38-39	TC-S03	104	TDD05080	447
TC-160UR	102	TCEMM417N	37	TC-S03AL	101	TDD06100	447
TC-180CLOCK	98	TCEMM631N	48-49	TC-S03AR	101	TDD08125	447
TC187	68	TCF01	93	TC-S04	104	TDD10150	447
TC205NF	77	TCF02	93	TCSB	91	TDD12175	447
TC-3	89	TCF03	93	TCSB16	91	TD03050	446
TC-4	89	TCF04	93	TC-SC	89	TD04070	446
TC450	91	TC-FB01	102	TC-SL01	100	TD05080	446
TC-4SBL	89	TC-FB02	102	TC-SL02	100	TD06100	446
TC540	90	TC-FB03	102	TC-SL03AL	101	TD08125	446
TC-540W	90	TC-H01	102	TC-SL03AR	101	TD10150	446
TC-6T	89	TC-H02	102	TCSMC	97	TD12175	446
TC-6T01	66	TC-H03	102	TCT01	103	TEA01	155
TC-6TE01	66	TC-H04	102	TCT02	103	TEA02	155
TC803N	78	TC-H05	102	TCT03	103	TEA1487	159, 196
TC803NBK	79	TC-LBK	102	TCT04	103	TEA9214LAF	165, 229
TC803SV	79	TC-LEG	102	TC-TB01	96	TEA9216AF	165, 229
TC805NFX	76	TC-LOCK3	98	TC-TB02	96	TEABS50	176, 364
TC805SV	77	TC-LOCK5	98	TC-TB03	96	TEAHR81	182, 490
TC806NBK	75	TC-MAG	96	TCTMC	97	TEAMDQ78	176, 374
TC806NF	75	TC-MAT	92	TC-UPRL	102	TEASD38	167, 282
TC806NGM	75	TCMM1001BK	20-21	TC-UPRLS	102	TEAVSD09	180, 430
TC806SV	76	TCMM1001N	18-19	TC-UPRR	102	TED00	155
TC810N	78	TCMM1001P	20-21	TC-UPRRS	102	TED01	155
TC8140NF	58	TCMM1004N-BK1	55	TCW207N	85	TED1227	160, 215
TC8140P	59	TCMM1034N	16-17	TCW208NBK1	85	TED1489	159, 196
TC816STACK	72	TCMM1055N	22-23	TCW707EV	82	TED3836	160, 205
TC816SV	73	TCMM277EV	47	TCW803N	80	TED441-T	178, 408
TC819BK	72	TCMM479	28-29	TCW804N	80	TED6512R	170, 311
TC819NBK	72	TCMM491N	46	TCW806LN	86	TED6512RS	170, 313
TC820SV	58	TCMM545N	56-57	TCW806N	81	TED6515	168, 300
TC-90CLOCK	98	TCMM546N	44-45	TCW806N1	81	TED8012	168, 306
TCA01	94	TCMM569EV	30-31	TCW807N	82	TED909TXN	172, 345
TCA05	92	TCMM600	26-27	TCW808N	83	TED911N	172, 344
TCA06	496	TCMM622N	40-41	TCW809N	86	TED9121	165, 230
TCA06RK	496	TCMM715N	24-25	TCW810N	83	TEDADJ4	171, 329
TCA07	496	TCMME09A	36	TCW810NBK	84	TEDDF7	171, 322
TCATV	95	TCMME09B	60	TCW814N	87	TEDHEX7	176, 389

TEDHT42	177, 390	TJ1415	190	TQS055	293	TTADJ04	131, 329
TEDIMM	181, 456	TJ1419	190	TQS065	293	TTADP17	121, 241
TEDPC14	182, 502	TJ1420	191	TR070	99	TTAF32	114, 203
TEDSD14	167, 283, 377	TJ1429	365	TRI35	99	TTAF3212	114, 203
TEDTX7	177, 395	TJ1430	365	TRC1012	465	TTALU	110
TEDV3818	181, 435	TJ149	462	TRC1418	465	TTBE18	150, 480
TEDV440	180, 432	TJNS05	366	TT00	110	TTBM	147, 456
TEDV909N	180, 428	TJSE05S	448, 478	TT01	110	TTBS35	116, 204
TEFMB7	156	TM010	367	TT02	110	TTBS53	138, 364
TEFMBP7	156	TM029	367	TT03	110	TTCP04	151, 483
TEFMD54	174	TM035NF	69	TT04	110	TTCP121	151, 482
TEFMDI54	175	TM079	202	TT1205	116, 212	TTD00	111
TEFSK57	162	TM079E	202	TT1211	116, 212	TTD01	111
TEX02	155	TM095	222	TT1215AF	118, 213	TTD02	111
TEX1238	168, 285	TM106	222	TT1217	117, 212	TTD441	140, 408
TEX2032	169, 300	TM111	223	TT1217-6	117, 212	TTD441-T	140, 408
TEX3403	161, 220	TM127	223	TT1218	117, 213	TTD912TXN	133, 344
TEX3410	162, 220	TM708	334	TT1218-6	117, 213	TTD914N	132, 343
TEX6308	171, 318	TMCO10	368	TT1236	126, 299	TTD9416	123, 229
TEX915N	172, 345	TMTX10	368	TT1435	113, 195	TTDAWM13M	153, 509
TEXEXT13	161, 239	TORP01A	295	TT143512	114, 195	TTDB28	145, 446
TEXFLS06	171, 318	TORP01E	295	TT1448	114, 195	TTDCM	147, 456
TEXMDTN	175, 341	TORP01U	295	TT3592	126, 300	TTDCT05	145, 440
TEXMP12	168, 293	TORQ	295	TT3816	115, 204	TTDTD34	146, 448
TEXPB4	182, 481	TORQ02	294	TT381612	115, 204	TTDV910N	143, 428
TEXTB05	181, 464	TORQ02A	294	TT3819	115, 203	TTAF62	169
TEXW05	182, 471	TORQ02U	294	TT381912	115, 203	TTEISK33	166
TEZ01	155	TORQ03	294	TT440	139, 407	TTEISK73	166
TF22	484	TORQ03A	294	TT440-T	140, 407	TTEMB11	178
TF2230RK	484	TORQ03U	294	TT474-5	141, 416	TTEMB17	179
TF30	484	TORQ04	294	TT474-5E	141, 415	TTEMD122N	173
TF300	486	TORQ04A	294	TT474-7	141, 417	TTEMD33	174
TF300RK	486	TORQ04U	294	TT474-7E	141, 416	TTEMD98N	173
TF76	485	TORQ05	294	TT6010M	126, 308	TTEPS12	157
TF76RK	485	TORQ05A	294	TT6010MRS	128, 315	TTEPS15	157
TFA0252RK	486	TORQ05U	294	TT6208	130, 320	TTEPS25	156
TFA10	486	TORQ99A	294	TT6506	130, 322	TTESK126	163
TFA12	486	TORQ99E	294	TT6508R	127, 311	TTESK32	162
TFA15	486	TORQ99U	294	TT6508RAF	128, 311	TTESK63	161
TFA22	486	TORQA	295	TT6508RF	128, 315	TTESK77	164
TFP01	485	TORQS01	295	TT6508RS	129, 313	TTESK85	164
TFP01RK	485	TORQU	295	TT6511R	128, 311	TTESK86	163
TFP02	485	TPM01	105	TT6511RS	129, 313	TTESP28	158
TFP02RK	485	TPM02	105	TT8012	126, 306	TTESP31	169
TGMUNC	455	TPT01	104	TT804	149, 477	TTESP37	170
THBS22	363	TPX2501003	357	TT9015HX	123, 228	TTEVG11	179
THBSI22	363	TPX2501503	357	TT9024	121, 226	TTEX17	158
T-HD	241	TPX2502003	357	TT9116N	122, 227	TTEX23N	177
T-HD01	251, 465	TPX2502503	357	TT9120DN	122, 228	TTEX32	170
THDV105	67	TPX2502703	357	TT917N	132, 343	TTHC03	148, 463
THDV105E	67	TPX2503003	357	TT917TXN	133, 343	TTHEX16	118, 213
TJ028	365	TPX2504003	357	TT9207	121, 227	TTHEX23	118, 214
TJ1412	365	TQAG	292	TT9207A	122, 227	TTHEX7	138, 388
TJ1413	366	TQS018	293	TT9212	122, 227	TTHEX7AF	139, 389
TJ1414	366	TQS042	293	TT9212TX	123, 228	TTHEX7S	138, 389

